



Industrial Automation Headquarters

Delta Electronics, Inc.
Taoyuan Technology Center
No.18, Xinglong Rd., Taoyuan City,
Taoyuan County 33068, Taiwan
TEL: 886-3-362-6301 / FAX: 886-3-371-6301

Asia

Delta Electronics (Jiangsu) Ltd.
Wujiang Plant 3
1688 Jiangxing East Road,
Wujiang Economic Development Zone
Wujiang City, Jiang Su Province, P.R.C. 215200
TEL: 86-512-6340-3008 / FAX: 86-769-6340-7290

Delta Greentech (China) Co., Ltd.
238 Min-Xia Road, Pudong District,
ShangHai, P.R.C. 201209
TEL: 86-21-58635678 / FAX: 86-21-58630003

Delta Electronics (Japan), Inc.
Tokyo Office
2-1-14 Minato-ku Shibadaimon,
Tokyo 105-0012, Japan
TEL: 81-3-5733-1111 / FAX: 81-3-5733-1211

Delta Electronics (Korea), Inc.
1511, Byucksan Digital Valley 6-cha, Gasan-dong,
Geumcheon-gu, Seoul, Korea, 153-704
TEL: 82-2-515-5303 / FAX: 82-2-515-5302

Delta Electronics Int'l (S) Pte Ltd.
4 Kaki Bukit Ave 1, #05-05, Singapore 417939
TEL: 65-6747-5155 / FAX: 65-6744-9228

Delta Electronics (India) Pvt. Ltd.
Plot No 43 Sector 35, HSIIDC
Gurgaon, PIN 122001, Haryana, India
TEL : 91-124-4874900 / FAX : 91-124-4874945

Americas

Delta Products Corporation (USA)
Raleigh Office
P.O. Box 12173, 5101 Davis Drive,
Research Triangle Park, NC 27709, U.S.A.
TEL: 1-919-767-3800 / FAX: 1-919-767-8080

Delta Greentech (Brasil) S.A.
Sao Paulo Office
Rua Itapeva, 26 - 3° andar Edifício Itapeva One-Bela Vista
01332-000-São Paulo-SP-Brazil
TEL: 55 11 3568-3855 / FAX: 55 11 3568-3865

Europe

Deltronics (The Netherlands) B.V.
Eindhoven Office
De Witbogt 20, 5652 AG Eindhoven, The Netherlands
TEL: 31-40-2592850 / FAX: 31-40-2592851

AH-0109420-04

*We reserve the right to change the information in this manual without prior notice.

2017-03-31

AH500 Operation Manual



AH500 Operation Manual

www.deltaww.com



AH500 Operation Manual

Revision History

Version	Revision	Date
1 st	1. The first version was published.	2013/03/28
2 nd	<p>2. The information about AHPS15-5A, AH32AM10N-5A, AH32AM10N-5C, AH16AR10N-5A, AH32AN02T-5A, AH32AN02T-5C, AH32AN02P-5A, AH32AN02P-5C, AH08AD-5C, AH08DA-5C, AH08PTG-5A, AH15PM-5A, AH10PFBM-5A, AH10PFBS-5A, AH10COPM-5A, AHRTU-PFBS-5A, AHAADP01/02EF-5A, and DVPAETB-IO34C is added to all chapters.</p> <p>3. The storage temperature, the program capacity of AHCPU500, the specifications for the input/output relays, the functional specifications for the analog input/output modules, the electrical specifications for the temperature measurement modules, the response characteristics of the input terminals on AH05PM-5A/AH10PM-5A in Chapter 2 are updated.</p> <p>4. The specifications for AH16AR10N-5A, and, the specifications for AH15PM-5A, and the specifications for AHPS15-5A are added to Chapter 2.</p> <p>5. Section 4.2.1 is updated.</p> <p>6. Section 5.1.1 is updated.</p> <p>7. Point (6) is added to section 6.6.1.</p> <p>8. Section 9.3.2.1 is updated.</p> <p>9. Section 11.2.3 is updated, and section 11.3 is added to Chapter 11.</p> <p>10. The troubleshooting for new models is added to Chapter 12.</p> <p>11. The AH500 addresses of the T devices and the AH500 addresses of the C devices in Appendix B are updated.</p>	2014/06/13
3 rd	<p>1. Information concerning AHCPU511-RS2, AHCPU511-EN, AHCPU521-EN, AHCPU531-EN, AH08AD-5A and AH08DA-5A is added.</p> <p>2. Information concerning larger program capacity and memory, Serial control interface with multiple functions and high-speed Ethernet communication interface is updated to section 1.3.</p> <p>3. Instruction execution speed, maximum number of Information concerning backplanes which can be connected is updated in section 2.2.1. Information concerning AH500 advanced CPU modules is added to section 2.2.2. Information concerning arrangement of AH32AN02P-5 input/output terminals is updated in section 2.4.4. Information concerning Interrupt input terminals of AH05PM-5A and input signals as well as terminal X1.2~X1.5 of AH15PM-5A and AH20MC-5A is updated in section 2.8.1. Informaiton concering the applicable input/output module is updated in section 2.11.1.</p> <p>4. Information concerning latched area in the device</p>	2016/08/15

Version	Revision	Date
	<p>range is updated in section 5.1.4.</p> <ol style="list-style-type: none"> 5. Information concerning specifications for SD card is updated in section 7.1.2. 6. Information concerning address is updated in section 8.3.2. 7. Information concerning AHCPU5X0 is added in chapter 9. 8. Information concerning AHCPU5X0 is added to section 11.1, 11.1.4, 11.2, 11.3, and 11.4. 9. Section 12.2.1, 12.2.2, 12.2.3, 12.2.5, 12.3.2, 12.4.1 are updated. 10. Information concerning installation in Windows 8 is added in Appendix A. 11. Section B.2 is removed from Appendix B. 	
4 th	<ol style="list-style-type: none"> 1. New contents concerning AH15SCM-5A, AHRTU-ETHN-5A are added in chapter 1. 2. New contents concerning module weights are added in chapter 2 and I/O connection cable models input/output terminals of AH series are also updated. 3. New information about EtherNet/IP is added in section 11.5. 4. New contents concerning EtherNet/IP troubleshooting are added in section 12.2.5 and delete the error codes 16#9B01~16#9B20. 5. New contents concerning installing the USB driver in Windows 7 and Windows 10 are added in Appendix A. 	2017/03/31

AH500 Operation Manual

Table of Contents

Chapter 1 Introduction

1.1	Introduction.....	1-2
1.1.1	Related Manuals.....	1-2
1.1.2	Description of Models.....	1-2
1.2	Overview	1-8
1.3	Characteristics.....	1-9

Chapter 2 Specifications and System Configuration

2.1	General Specifications.....	2-3
2.2	Specifications for CPU Modules.....	2-3
2.2.1	Performance Specifications.....	2-3
2.2.2	Profiles.....	2-6
2.3	Basic System Configuration.....	2-8
2.3.1	Introduction	2-8
2.3.2	Configuring a Main Backplane	2-9
2.3.3	Configuring an Extension Backplane.....	2-9
2.3.4	Maximum Extension.....	2-9
2.4	Specifications for Digital Input/Output Modules.....	2-10
2.4.1	General Specifications	2-10
2.4.2	Profiles.....	2-13
2.4.3	Dimensions	2-21
2.4.4	Arrangement of Input/Output Terminals.....	2-26
2.5	Specifications for Analog Input/Output Modules.....	2-34
2.5.1	General Specifications	2-34
2.5.2	Profiles.....	2-39
2.5.3	Dimensions	2-40
2.5.4	Arrangement of Input/Output Terminals.....	2-42
2.5.5	Setting Parameters	2-44
2.6	Specifications for Temperature Measurement Modules.....	2-47
2.6.1	General Specifications	2-47
2.6.2	Profiles.....	2-49
2.6.3	Dimensions	2-50
2.6.4	Arrangement of Input/Output Terminals.....	2-51
2.6.5	Setting Parameters	2-52
2.7	Specifications for Network Modules	2-54
2.7.1	General Specifications	2-54

2.7.2	Profiles	2-57
2.7.3	Dimensions.....	2-65
2.7.4	Arrangement of Input/Output Terminals	2-68
2.7.5	Setting Parameters.....	2-69
2.8	Specifications for Motion Control Modules	2-72
2.8.1	General Specifications	2-72
2.8.2	Profiles	2-83
2.8.3	Dimensions.....	2-89
2.8.4	Arrangement of Input/Output Terminals	2-92
2.8.5	Setting Parameters.....	2-97
2.9	Specifications for Remote Input/Output Modules	2-99
2.9.1	General Specifications	2-99
2.9.2	Profiles	2-100
2.9.3	Dimensions.....	2-104
2.10	Specifications for Power Supply Modules	2-106
2.10.1	General Specifications	2-106
2.10.2	Profiles.....	2-107
2.10.3	Dimensions.....	2-108
2.10.4	Arrangement of Terminals.....	2-109
2.11	Space Module, Backplanes, and Extension Cables	2-110
2.11.1	General Specifications	2-110
2.11.2	Profiles.....	2-111
2.11.3	Dimensions.....	2-114

Chapter 3 Installing Software

3.1	Installing and Uninstalling ISPSOft.....	3-2
3.1.1	Installing ISPSOft	3-2
3.1.2	Uninstalling ISPSOft.....	3-6
3.2	Installing and Uninstalling COMMGR	3-7
3.2.1	Installing COMMGR.....	3-7
3.2.2	Uninstalling COMMGR.....	3-9

Chapter 4 Installing Hardware

4.1	Installation	4-2
4.1.1	Mounting a Backplane	4-2
4.1.2	Installing a Module.....	4-4
4.2	Wiring.....	4-5
4.2.1	Wiring a Power Supply Module.....	4-5

4.2.2	Wiring I/O Modules	4-7
 Chapter 5 Devices		
5.1	Introduction of Devices	5-2
5.1.1	Devise Table	5-2
5.1.2	Basic Structure of I/O Storages	5-4
5.1.3	Relation Between the PLC Action and the Device Type.....	5-4
5.1.4	Latched Areas in the Device Range	5-5
5.2	Functions of Devices	5-6
5.2.1	Values and Constants	5-6
5.2.2	Floating-point Numbers	5-7
5.2.3	Strings.....	5-7
5.2.4	Input Relays.....	5-7
5.2.5	Output Relays	5-7
5.2.6	Auxiliary Relays	5-7
5.2.7	Special Auxiliary Relays	5-8
5.2.8	Stepping Relays.....	5-8
5.2.9	Timers.....	5-8
5.2.10	Counters	5-9
5.2.11	32-bit Counters.....	5-9
5.2.12	Data Registers	5-10
5.2.13	Special Data Registers.....	5-10
5.2.14	Link Registers	5-10
5.2.15	Index Registers	5-10
 Chapter 6 Writing a Program		
6.1	Quick Start.....	6-2
6.1.1	Example.....	6-2
6.1.2	Hardware	6-2
6.1.3	Program.....	6-2
6.2	Procedure for Creating a Project in ISPSOft.....	6-3
6.3	Creating a Project.....	6-3
6.4	Hardware Configuration	6-4
6.4.1	Configuring a Module	6-5
6.4.2	Setting the Parameters in a CPU Module and a Module	6-6
6.5	Creating a Program	6-8
6.5.1	Adding a Ladder Diagram	6-9
6.5.2	Basic Editing—Creating a Contact and a Coil	6-11

6.5.3	Basic Editing—Inserting a Network and Typing an Instruction.....	6-14
6.5.4	Basic Editing—Selection of a Network and Operation.....	6-16
6.5.5	Basic Editing—Connecting a Contact in Parallel.....	6-17
6.5.6	Basic Editing—Editing a Comment	6-18
6.5.7	Basic Editing—Inserting an Applied Instruction	6-19
6.5.8	Basic Editing—Creating a Comparison Contact and Typing a Constant.....	6-21
6.5.9	Writing a Program.....	6-22
6.5.10	Checking and Compiling a Program.....	6-23
6.6	Testing and Debugging a Program.....	6-23
6.6.1	Creating a Connection	6-23
6.6.2	Downloading a Program and Parameters	6-26
6.6.3	Connection Test.....	6-27
6.7	Setting a Real-time Clock.....	6-34

Chapter 7 Memory Card

7.1	Overview of Memory Cards	7-2
7.1.1	Appearances of Memory Cards	7-2
7.1.2	Specifications for SD Cards	7-2
7.2	Using a Memory Card.....	7-3
7.2.1	Formatting a Memory Card	7-3
7.2.2	Write Protect Function of a Memory Card	7-4
7.3	Installing and Removing a Memory Card.....	7-5
7.3.1	SD Slot in a CPU Module.....	7-5
7.3.2	Installing a Memory Card	7-6
7.3.3	Removing a Memory Card	7-6
7.4	Contents of a Memory Card.....	7-6
7.4.1	Initializing a Memory Card	7-6
7.4.2	Folder Structure in a Memory Card.....	7-7
7.5	Reading/Writing a Memory Card	7-7
7.5.1	Backing up the System	7-7
7.5.2	Restoring the System	7-8
7.6	Introduction of CARD Utility.....	7-9
7.7	Backup.....	7-11
7.8	Restoration.....	7-14

Chapter 8 Hardware Configuration

8.1	Hardware Configuration Tool for AH500 Series Modules—HWCONFIG.....	8-3
8.1.1	Introduction of the Environment of HWCONFIG.....	8-3

8.1.2	Configuring a Module	8-5
8.1.2.1	Adding a Module	8-5
8.1.2.2	Assigning Devices to a Module	8-8
8.1.2.3	Editing a Comment	8-12
8.1.2.4	Deleting a Module	8-13
8.1.2.5	Replacing a Module	8-13
8.1.2.6	Searching for/Replacing a Module	8-14
8.1.2.7	Copying/Pasting a Module	8-18
8.1.2.8	Cutting/Pasting a Module	8-20
8.1.2.9	Dragging a Module.....	8-21
8.1.2.10	Adding an Extension Rack	8-22
8.1.2.11	Deleting a Rack.....	8-23
8.1.2.12	Replacing a Rack.....	8-24
8.1.2.13	Cutting/Copying/Pasting an Extension Rack	8-25
8.1.2.14	Dragging an Extension Rack.....	8-28
8.1.2.15	Rearranging the Input/Output Devices	8-28
8.2	Setting the Parameters in an AH500 Series CPU Module.....	8-29
8.2.1	Opening the PLC Parameter Setting Window.....	8-29
8.2.2	Setting the Basic CPU Parameters	8-30
8.2.2.1	CPU: Name.....	8-30
8.2.2.2	CPU: System	8-31
8.2.2.3	CPU: Latched Device Range	8-34
8.2.3	COM Port.....	8-36
8.2.4	Ethernet—Basic	8-37
8.2.5	Ethernet—Advance	8-38
8.2.5.1	Ethernet—Advance: Filter	8-38
8.2.5.2	Ethernet—Advance: NTP	8-40
8.2.5.3	Ethernet—Advance: Email	8-41
8.2.5.4	Ethernet—Advance: Email Trigger	8-42
8.2.5.5	Ethernet—Advance: Email and Trigger Configuration	8-45
8.2.5.6	Ethernet—Advance: Socket	8-46
8.2.5.7	Ethernet—Advance: Web.....	8-48
8.2.6	Saving and Downloading/Uploading the PLC Parameters.....	8-49
8.3	Setting the Parameters in an AH500 Series Module	8-50
8.3.1	Managing the Version of a Module	8-50
8.3.2	Setting the Parameters in a Module	8-52
8.3.3	Exporting and Importing the Parameters in a Module.....	8-56
8.3.4	Setting the Parameters in an Intelligent Module	8-57

8.4	Management of the Parameters in AH500 Series Hardware and Online Diagnosis	8-58
8.4.1	Saving and Printing a Hardware Configuration	8-58
8.4.2	Purchase Order	8-59
8.4.3	Rack Information List	8-60
8.4.4	Downloading/Uploading the System Parameters	8-61
8.4.5	I/O Scan	8-62
8.4.6	Online Diagnosis.....	8-63
8.4.6.1	Online Mode	8-64
8.4.6.2	Module Information and Diagnosis.....	8-65
8.4.6.3	Changing the Status of a Module Online.....	8-66
8.4.6.4	Monitoring Table	8-68
8.5	Setting Interrupts	8-69
8.5.1	Program Architectures	8-69
8.5.2	Tasks Supported by AH500 Series CPU Modules.....	8-69
8.5.3	I/O Interrupts.....	8-70
8.5.4	Low Voltage Detection Interrupt.....	8-71
8.5.5	Communication Interrupts.....	8-71
8.5.6	External Interrupts	8-72
8.5.7	Timer Interrupts	8-73

Chapter 9 Network Configuration

9.1	Network Configuration Tool—NWCONFIG	9-2
9.1.1	Introduction of NWCONFIG	9-2
9.1.2	Basic Knowledge	9-3
9.1.3	Communication Setting in NWCONFIG	9-4
9.1.3.1	Connection Mechanism in NWCONFIG	9-5
9.1.3.2	Setting Communication Parameters	9-6
9.1.4	Workflow.....	9-7
9.2	Creating a Network Architecture	9-12
9.2.1	Deploying Nodes	9-12
9.2.2	Connecting to a Network.....	9-15
9.2.3	Adjusting or Deleting Devices or Networks	9-20
9.2.4	Setting the Attributes of a Node/Network	9-23
9.2.5	Hiding/Displaying Devices or Networks.....	9-27
9.2.6	Correct Network Architecture	9-30
9.2.7	Downloading Routing Tables.....	9-33
9.2.8	Testing Routing.....	9-34

9.3	Managing and Applying NWCONFIG	9-36
9.3.1	Saving Parameters and Printing a Network Framework	9-36
9.3.2	Downloading Parameters	9-37
9.3.2.1	Introduction of Parameters	9-37
9.3.2.2	Description of Downloading Parameters	9-38
9.3.3	Using Routing in ISPSOft	9-39
Chapter 10 Operating Principle of the CPU Module		
10.1	Operation of the CPU Module	10-2
10.1.1	Procedure	10-2
10.1.2	I/O Refreshing and Communication Service	10-3
10.2	Operating Modes of the CPU Module	10-3
10.2.1	Operating Modes	10-3
10.2.2	Statuses and Operation under Different Operating Modes	10-3
Chapter 11 Convenient Functions		
11.1	PLC Link (for AHCPU5X0 models)	11-2
11.1.1	Introduction of a PLC Link	11-2
11.1.2	Constructing a PLC Link in NWCONFIG in ISPSOft	11-2
11.1.2.1	Opening the PLC Link Table Editor Window	11-3
11.1.2.2	Designating a Port as a Master Station (Step 1)	11-4
11.1.2.3	Setting Communication Parameters (Step 2)	11-6
11.1.2.4	Creating a Data Exchange Table (Step 3)	11-7
11.1.2.5	Monitoring a PLC Link	11-14
11.1.2.6	Important Points About Constructing a PLC Link	11-18
11.1.3	Executing a PLC Link through the Program in ISPSOft	11-20
11.1.3.1	Parameters Related to a PLC Link	11-20
11.1.3.2	Setting a PLC Link	11-25
11.1.4	Related Special Auxiliary Relays and Special Data Registers	11-31
11.2	Ether Link (for AHCPU5X0 models)	11-33
11.2.1	Introduction of an Ether Link	11-33
11.2.1.1	General Specifications and Functions	11-34
11.2.1.2	Steps of Constructing an Ether Link	11-35
11.2.2	Constructing an Ether Link in NWCONFIG in ISPSOft	11-36
11.2.2.1	Constructing an Ether Link	11-36
11.2.2.2	Opening the Ether Link Configuration Window	11-36
11.2.2.3	Creating and Managing a Data Exchange Table	11-38
11.2.2.4	Node List and Display Area	11-41

11.2.2.5	Start Mode of an Ether Link	11-43
11.2.2.6	Downloading the Parameters Related to an Ether Link.....	11-45
11.2.2.7	Uploading the Parameters Related to an Ether Link	11-47
11.2.2.8	Deleting Asynchronous Device	11-48
11.2.2.9	Enabling/Disabling the Online Monitoring Function	11-49
11.2.2.10	Starting/Stopping the Execution of an Ether Link Online	11-53
11.2.2.11	Monitoring Table and Error Log.....	11-56
11.2.3	Related Special Auxiliary Relays and Special Data Registers	11-57
11.3	Data Exchange Function	11-60
11.3.1	MODBUS Data Exchange.....	11-60
11.3.1.1	MODBUS Data Exchange.....	11-60
11.3.1.2	MODBUS Data Exchange - PLC Parameter Setting	11-60
11.3.1.3	MODBUS Data Exchange - Downloading/Uploading Parameters	11-63
11.3.1.4	MODBUS Data Exchange – Special Auxiliary Relays	11-64
11.3.2	MODBUS TCP Data Exchange.....	11-87
11.3.2.1	MODBUS TCP Data Exchange.....	11-87
11.3.2.2	MODBUS TCP Data Exchange - PLC Parameter Setting	11-88
11.3.2.3	MODBUS TCP Data Exchange - Downloading/Uploading Parameters.....	11-93
11.3.2.4	MODBUS TCP Data Exchange – Special Auxiliary Relays.....	11-95
11.4	Web.....	11-128
11.4.1	Introduction.....	11-128
11.4.2	Usage	11-128
11.4.3	Troubleshooting	11-130
11.5	EtherNet/IP.....	11-133

Chapter 12 Troubleshooting

12.1	Troubleshooting.....	12-2
12.1.1	Basic Inspection.....	12-2
12.1.2	Eliminating Errors	12-2
12.1.3	Troubleshooting Procedure.....	12-3
12.1.4	Viewing Error Logs.....	12-4
12.2	Troubleshooting for CPU Modules.....	12-5
12.2.1	ERROR LED Indicator's Being ON	12-5
12.2.2	ERROR LED Indicator's Blinking	12-6
12.2.3	BUS FAULT LED Indicator's Being ON.....	12-11
12.2.4	BUS FAULT LED Indicator's Blinking.....	12-12
12.2.5	Troubleshooting for EtherNet/IP.....	12-13

12.2.6	Others	12-14
12.3	Troubleshooting for I/O Modules	12-29
12.3.1	Troubleshooting for Analog I/O Modules and Temperature Measurement Modules	12-30
12.3.2	Troubleshooting for AH02HC-5A/AH04HC-5A	12-32
12.3.3	Troubleshooting for AH05PM-5A/AH10PM-5A/AH15PM-5A.....	12-34
12.3.4	Troubleshooting for AH20MC-5A	12-35
12.3.5	Troubleshooting for AH10EN-5A	12-36
12.3.6	Troubleshooting for AH10SCM-5A	12-37
12.3.7	Troubleshooting for AH10DNET-5A	12-37
12.3.8	Troubleshooting for AH10PFBM-5A	12-38
12.3.9	Troubleshooting for AH10PFBS-5A.....	12-39
12.3.10	Troubleshooting for AH10COPM-5A	12-39
12.4	Error Codes and LED Indicators	12-41
12.4.1	CPU Modules.....	12-41
12.4.2	Analog I/O Modules and Temperature Measurement Modules.....	12-55
12.4.3	AH02HC-5A/AH04HC-5A.....	12-56
12.4.4	AH05PM-5A/AH10PM-5A/AH15PM-5A	12-56
12.4.5	AH20MC-5A.....	12-57
12.4.6	AH10EN-5A	12-58
12.4.7	AH10SCM-5A/AH15SCM-5A	12-59
12.4.8	AH10DNET-5A.....	12-59
12.4.9	AH10PFBM-5A.....	12-60
12.4.10	AH10PFBS-5A	12-60
12.4.11	AH10COPM-5A.....	12-61

Appendix A Installing a USB Driver

A.1	Installing the USB Driver for an AH500 Series CPU module in Windows XP with SP3	A-2
A.2	Installing the USB Driver for an AH500 Series CPU module in Windows 7.....	A-6
A.3	Installing the USB Driver for an AH500 Series CPU module in Windows 8.....	A-10
A.4	Installing the USB Driver for an AH500 Series CPU module in Windows 10.....	A-13

Appendix B Device Addresses

B.1	Device Addresses.....	B-2
-----	-----------------------	-----



Chapter 1 Introduction

Table of Contents

1.1	Introduction.....	1-2
1.1.1	Related Manuals.....	1-2
1.1.2	Description of Models.....	1-2
1.2	Overview	1-8
1.3	Characteristics.....	1-9



1.1 Introduction

This manual introduces functions of CPUs, devices, module tables, troubleshooting, and etc.

1.1.1 Related Manuals

The related manuals of the AH500 series programmable logic controllers are composed of the following

- **AH500 Quick Start**
It guides users to use the system before they read the related manuals.
- **AH500 Programming Manual**
It introduces the programming of the AH500 series programmable logic controllers, the basic instructions, and the applied instructions.
- **ISPSOft User Manual**
It introduces the use of ISPSOft, the programming language (Ladder, IL, SFC, FBD, and ST), the concept of POU, and the concept of tasks.
- **AH500 Hardware Manual**
It introduces electrical specifications, appearances, dimensions, and etc.
- **AH500 Operation Manual**
It introduces functions of CPUs, devices, module tables, troubleshooting, and etc.
- **AH500 Module Manual**
It introduces the use of special I/O modules. For example, network modules, analog I/O modules, temperature measurement modules, motion control modules, and etc.
- **AH500 Motion Control Module Manual**
It introduces the specifications for the motion control modules, the wiring, the instructions, and the functions.
- **PMSOft User Manual**
It introduces the use of PMSOft, including the editing mode, the connection, and the password setting.

1.1.2 Description of Models

Classification	Model Name	Description
Power supply module	AHPS05-5A	100~240 V AC 50/60 Hz
	AHPS15-5A	24 V DC
CPU module	AHCPU500-RS2	It is a basic CPU module with two built-in RS-485 ports, one built-in USB port, and one built-in SD interface. It supports 768 inputs/outputs. The program capacity is 32K steps.
	AHCPU500-EN	It is a basic CPU module with one built-in Ethernet port, one built-in RS-485 port, one built-in USB port, and one built-in SD interface. It supports 768 inputs/outputs. The program capacity is 32K steps.
	AHCPU510-RS2	It is a basic CPU module with two built-in RS-485 ports, one built-in USB port, and one built-in SD interface. It supports 1280 inputs/outputs. The program capacity is 64K steps.
	AHCPU510-EN	It is a basic CPU module with one built-in Ethernet port, one built-in RS-485 port, one built-in USB port, and one built-in SD interface. It supports 1280 inputs/outputs. The program capacity is 64K steps.
	AHCPU511-RS2	It is an advanced CPU module with two built-in RS-485 ports, one built-in USB port, and one built-in SD interface. It supports 1280 inputs/outputs. The program capacity is 96K steps.
	AHCPU511-EN	It is an advanced CPU module with one built-in Ethernet port, one built-in RS-485 port, one built-in USB port, and one built-in SD interface. It supports 1280 inputs/outputs. The program capacity is 96K steps.
	AHCPU520-RS2	It is a basic CPU module with two built-in RS-485 ports, one built-in USB port, and one built-in SD interface. It supports 2304

Classification	Model Name	Description
		inputs/outputs. The program capacity is 128K steps.
	AHCPU520-EN	It is a basic CPU module with one built-in Ethernet port, one built-in RS-485 port, one built-in USB port, and one built-in SD interface. It supports 2304 inputs/outputs. The program capacity is 128K steps.
	AHCPU521-EN	It is an advanced CPU module with one built-in Ethernet port, one built-in RS-485 port, one built-in USB port, and one built-in SD interface. It supports 2304 inputs/outputs. The program capacity is 192K steps.
	AHCPU530-RS2	It is a basic CPU module with two built-in RS-485 ports, one built-in USB port, and one built-in SD interface. It supports 4352 inputs/outputs. The program capacity is 256K steps.
	AHCPU530-EN	It is a basic CPU module with one built-in Ethernet port, one built-in RS-485 port, one built-in USB port, and one built-in SD interface. It supports 4352 inputs/outputs. The program capacity is 256K steps.
	AHCPU531-EN	It is an advanced CPU module with one built-in Ethernet port, one built-in RS-485 port, one built-in USB port, and one built-in SD interface. It supports 4352 inputs/outputs. The program capacity is 384K steps.
Main backplane	AHBP04M1-5A	Four-slot main backplane for a CPU/RTU rack
	AHBP06M1-5A	Six-slot main backplane for a CPU/RTU rack
	AHBP08M1-5A	Eight-slot main backplane for a CPU/RTU rack
	AHBP12M1-5A	Twelve-slot main backplane for a CPU/RTU rack
Extension backplane	AHBP06E1-5A	Six-slot extension backplane for a CPU/RTU extension rack
	AHBP08E1-5A	Eight-slot extension backplane for a CPU/RTU extension rack
Digital input/output module	AH16AM10N-5A	24 V DC 5 mA 16 inputs Terminal block
	AH16AM30N-5A	100~240 V AC 4.5 mA~9 mA (100 V, 50 Hz) 16 inputs Terminal block
	AH16AR10N-5A	24 V DC 5 mA 16 inputs Terminal block (I/O interrupts are supported.)
	AH32AM10N-5A	24 V DC 5 mA 32 inputs Terminal block
	AH32AM10N-5B	24 V DC 5 mA 32 inputs DB37 connector
	AH32AM10N-5C	24 V DC 5 mA 32 inputs Latch connector
	AH64AM10N-5C	24 V DC 3.2 mA 64 inputs Latch connector

1

Classification	Model Name	Description
	AH16AN01R-5A	240 V AC/24 V DC 2 A 16 outputs Relay Terminal block
	AH16AN01T-5A	12~24 V DC 0.5 A 16 outputs Sinking output Terminal block
Digital input/output module	AH16AN01P-5A	12~24 V DC 0.5 A 16 outputs Sourcing output Terminal block
	AH16AN01S-5A	100~240 V AC 0.5 A 16 outputs TRIAC Terminal block
	AH32AN02T-5A	12~24 V DC 0.1 A 32 outputs Sinking output Terminal block
	AH32AN02T-5B	12~24 V DC 0.1 A 32 outputs Sinking output DB37 connector
	AH32AN02T-5C	12~24 V DC 0.1 A 32 outputs Sinking output Latch connector
	AH32AN02P-5A	12~24 V DC 0.1 A 32 outputs Sourcing output Terminal block
	AH32AN02P-5B	12~24 V DC 0.1 A 32 outputs Sourcing output DB37 connector
	AH32AN02P-5C	12~24 V DC 0.1 A 32 outputs Sourcing output Latch connector
	AH64AN02T-5C	12~24 V DC 0.1 A 64 outputs Sinking output Latch connector

Classification	Model Name	Description
	AH64AN02P-5C	12~24 V DC 0.1 A 64 outputs Sourcing output Latch connector
Digital input/output module	AH16AP11R-5A	24 V DC 5 mA 8 inputs 240 V AC/24 V DC 2 A 8 outputs Relay Terminal block
	AH16AP11T-5A	24 V DC 5 mA 8 inputs 12~24 V DC 0.5 A 8 outputs Sinking output Terminal block
	AH16AP11P-5A	24 V DC 5 mA 8 inputs 12~24 V DC 0.5 A 8 outputs Sourcing output Terminal block
Analog input/output module	AH04AD-5A	Four-channel analog input module Hardware resolution: 16 bits 0/1 V~5 V, -5 V~5 V, 0 V~10 V, -10 V~10 V, 0/4 mA~20 mA, and -20 mA~20 mA Conversion time: 150 us/channel
	AH08AD-5A	Eight-channel analog input module Hardware resolution: 16 bits 0/1 V~5 V, -5 V~5 V, 0 V~10 V, -10 V~10 V, 0/4 mA~20 mA, and -20 mA~20 mA Conversion time: 150 us/channel
	AH08AD-5B	Eight-channel analog input module Hardware resolution: 16 bits 0/1 V~5 V, -5 V~5 V, 0 V~10 V, and -10 V~10 V Conversion time: 150 us/channel
	AH08AD-5C	Eight-channel analog input module Hardware resolution: 16 bits 0/4 mA~20 mA, and -20 mA~20 mA Conversion time: 150 us/channel
	AH04DA-5A	Four-channel analog output module Hardware resolution: 16 bits 0/1 V~5 V, -5 V~5 V, 0 V~10 V, -10 V~10 V, and 0/4 mA~20 mA Conversion time: 150 us/channel
	AH08DA-5A	Eight-channel analog output module Hardware resolution: 16 bits 0/1 V~5 V, -5 V~5 V, 0 V~10 V, and -10 V~10 V, and 0/4 mA~20 mA



Classification	Model Name	Description
		Conversion time: 150 us/channel
	AH08DA-5B	Eight-channel analog output module Hardware resolution: 16 bits 0/1 V~5 V, -5 V~5 V, 0 V~10 V, and -10 V~10 V Conversion time: 150 us/channel
	AH08DA-5C	Eight-channel analog output module Hardware resolution: 16 bits 0/4 mA~20 mA Conversion time: 150 us/channel
Analog input/output module	AH06XA-5A	Four-channel analog input module Hardware resolution: 16 bits 0/1 V~5 V, -5 V~5 V, 0 V~10 V, -10 V~10 V, 0/4 mA~20 mA, and -20 mA~20 mA Conversion time: 150 us/channel Two-channel analog output module Hardware resolution: 16 bits 0/1 V~5 V, -5 V~5 V, 0 V~10 V, -10 V~10 V, and 0/4 mA~20 mA Conversion time: 150 us/channel
Temperature measurement module	AH04PT-5A	Four-channel four-wire/three-wire RTD Sensor type: Pt100/Pt1000/Ni100/Ni1000 sensor, and 0~300 Ω input impedance Resolution: 0.1°C/0.1°F (16 bits) Four-wire conversion time: 150 ms/channel Three-wire conversion time: 300 ms/channel
	AH08PTG-5A	Eight-channel four-wire/three-wire/two-wire RTD Sensor type: Pt100/Pt1000/Ni100/Ni1000, and 0~300 Ω input impedance Resolution: 0.1°C/0.1°F (16 bits) Conversion time: 20 ms/4 channels and 200 ms/8 channels
	AH04TC-5A	Four-channel thermocouple Sensor type: J, K, R, S, T, E, N, and -150~+150 mV Resolution: 0.1°C/0.1°F Conversion time: 200 ms/channel
	AH08TC-5A	Eight-channel thermocouple Sensor type: J, K, R, S, T, E, N, and -150~+150 mV Resolution: 0.1°C/0.1°F Conversion time: 200 ms/channel
Motion control module	AH02HC-5A	Two-channel high-speed counter module (200 kHz)
	AH04HC-5A	Four-channel high-speed counter module (200 kHz)
	AH05PM-5A	Two-axis pulse train motion control module (1 MHz)
	AH10PM-5A	Six-axis pulse train motion control module (Four axes: 1 MHz; Two axes: 200 kHz)
	AH15PM-5A	Four-axis pulse train motion control module (1 MHz)
	AH20MC-5A	Twelve-axis DMCNET (Delta Motion Control Network) motion control module (10 Mbps)
Network module	AH10EN-5A	It is an Ethernet communication module. It can function as a master or a slave. It is equipped with two Ethernet ports, and supports a Modbus TCP master.
	AH10SCM-5A	It is a serial communication module with two RS-485/RS-422 ports, and supports Modbus and UD Link protocols. One part of communication is isolated from the other part of the communication, and one part of power is isolated from the other part of the power.
	AH15SCM-5A	It is a serial communication module with two RS-232 ports, and supports Modbus and UD Link protocols.

Classification	Model Name	Description
		One part of communication is isolated from the other part of the communication, and one part of power is isolated from the other part of the power.
	AH10DNET-5A	It is a DeviceNet communication module. It can function as a master or a slave. The maximum communication speed is 1 Mbps.
	AH10PFBM-5A	PROFIBUS-DP master module
	AH10PFBS-5A	PROFIBUS-DP slave module
	AH10COPM-5A	It is a CANopen communication module. It can function as a master or a slave.
Remote I/O module	AHRTU-DNET-5A	DeviceNet remote I/O module
	AHRTU-PFBS-5A	PROFIBUS-DP remote I/O module
	AHRTU-ETHN-5A	Ethernet remote I/O module
Extension cable	AHACAB06-5A	0.6 meter extension cable for connecting an extension backplane
Classification	Model Name	Description
Extension cable	AHACAB10-5A	1.0 meter extension cable for connecting an extension backplane
	AHACAB15-5A	1.5 meter extension cable for connecting an extension backplane
	AHACAB30-5A	3.0 meter extension cable for connecting an extension backplane
	AHAADP01EF-5A/ AHAADP02EF-5A	Fiber optics modules for extension backplanes
I/O extension cable	UC-ET010-24A	1.0 meter I/O extension cable (latch connector) for AH32AM10N-5C and AH64AM10N-5C
	UC-ET010-24C	1.0 meter I/O extension cable (latch connector) for AH32AN02T-5C, AH32AN02P-5C, AH64AN02T-5C and AH64AN02P-5C
	UC-ET010-33B	1.0 meter I/O extension cable (DB37 connector) for AH32AM10N-5B, AH32AN02T-5B, and AH32AN02P-5B
	UC-ET010-13B	1.0 meter I/O extension cable for AH04HC-5A and AH20MC-5A
	UC-ET010-15B	1.0 meter I/O extension cable for AH10PM-5A and AH15PM-5A
External terminal module	UB-10-ID32A	I/O external terminal module for AH32AM10N-5C and AH64AM10N-5C 32 inputs
	UB-10-ID32B	I/O external terminal module for AH32AM10N-5B 32 inputs
	UB-10-OR16A	I/O external terminal module for AH32AN02T-5C and AH64AN02T-5C 16 relay outputs
	UB-10-OR16B	I/O external terminal module for AH32AN02P-5C and AH64AN02P-5C 16 relay outputs
	UB-10-OR32A	I/O external terminal module for AH32AN02T-5B 32 relay outputs
	UB-10-OR32B	I/O external terminal module for AH32AN02P-5B 32 relay outputs
	UB-10-OT32A	I/O external terminal module for AH32AN02T-5C, AH32AN02P-5C, AH64AN02T-5C, and AH64AN02P-5C 32 transistor outputs
	UB-10-OT32B	I/O external terminal module for AH32AN02T-5B and AH32AN02P-5B 32 transistor outputs

1

Classification	Model Name	Description
	UB-10-IO16C	I/O external terminal module for AH04HC-5A and AH20MC-5A
	UB-10-IO24C	I/O external terminal module for AH10PM-5A
	UB-10-IO34C	I/O external terminal module for AH15PM-5A
Space module	AHASP01-5A	Space module used for an empty I/O slot

1.2 Overview

An AH500 series CPU module is a medium type of advanced controller with built-in communication ports. It provides a strong network function for users, and users can create connection among devices on the network through software. An AH500 series CPU module also provides structured programming. Users can assign programs to different tasks, and write a program which is frequently executed in a function block. Besides, users can choose different programming languages (instruction lists (IL), structured texts (ST), ladder diagrams (LD), sequential function charts (SFC), and function block diagrams (FBD)) dealt with by IEC 61131-3 according to their needs when writing programs. They can create the AH500 hardware configuration by means of hardware configuration software. They can also restore or back up a system rapidly through the built-in SD interface in an AH500 series CPU module. This manual introduces the basic operation of an AH500 system, and help users familiarize themselves with the AH500 system.

An AH500 series CPU module also provides structured programming. Users can assign programs to different tasks, and write a program which is frequently executed in a function block.

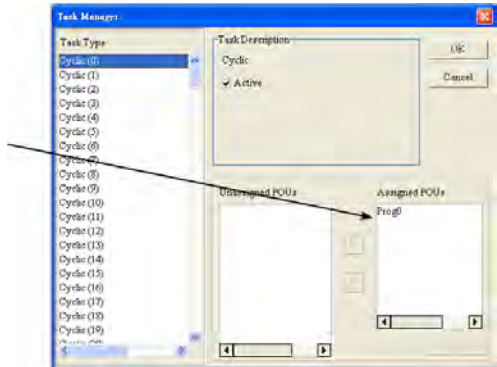

An AH500 series CPU module is a medium type of advanced controller with built-in communication ports. It provides a strong network function for users, and users can create connection among devices in the network through software.

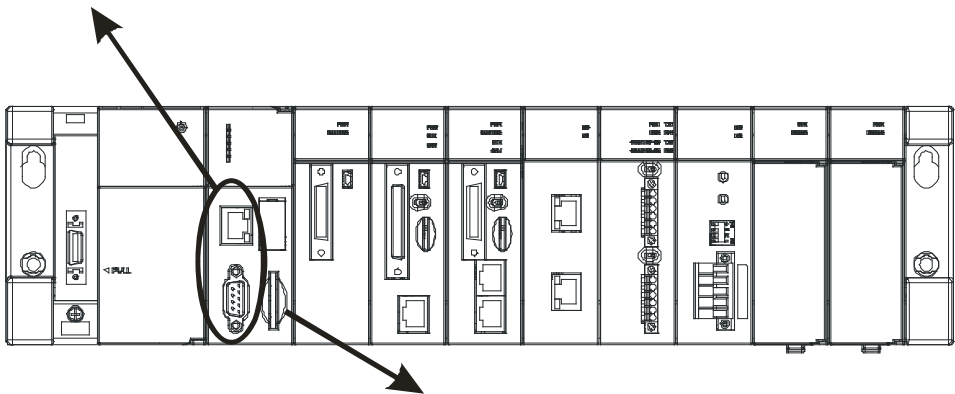

Users can restore or back up a system rapidly through the built-in SD interface in an AH500 series CPU module.

With ISPSOft, users can choose different programming languages (instruction lists (IL), structured texts (ST), ladder diagrams (LD), sequential function charts (SFC), and function block diagrams (FBD) dealt with by IEC 61131-3 according to their needs when writing program.

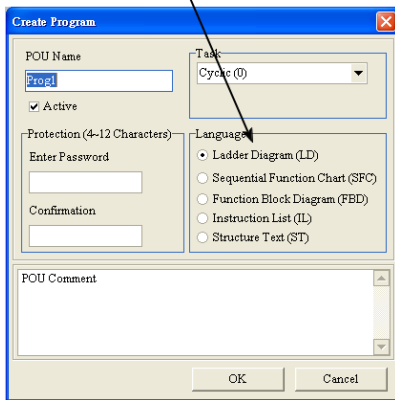

Users can create an AH500 hardware configuration by means of the hardware configuration software.

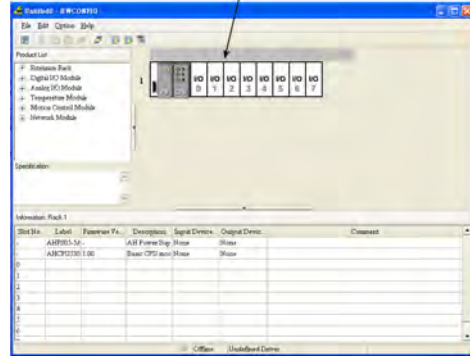

1.3 Characteristics

1. High efficiency

- AH500 basic series CPU module: A 32-bit high-speed processor is used. The instructions are executed at a speed of 3K steps/ms. (Fifty percent of the instructions are basic instructions, and fifty percent of the instructions are applied instructions.)
- AH500 advance series CPU module: A 32-bit high-speed processor is used. The instructions are executed at a speed of 12K steps/ms. (Fifty percent of the instructions are basic instructions, and fifty percent of the instructions are applied instructions.)

2. Supporting more inputs and outputs

- The AH500 series CPU module supports up to 4,352 local digital I/O or 544 analog I/O.
- A complete AH500 system consists of eight backplanes at most, including a main backplane. Twelve I/O modules at most can be installed on a main backplane, and eight I/O modules at most can be installed on an extension backplane. Therefore, for the AH500 series CPU, sixty-eight digital input/output modules at most or sixty-eight analog input/output modules at most can be installed.
- Eight RTU modules at most can be installed on the main backplane.

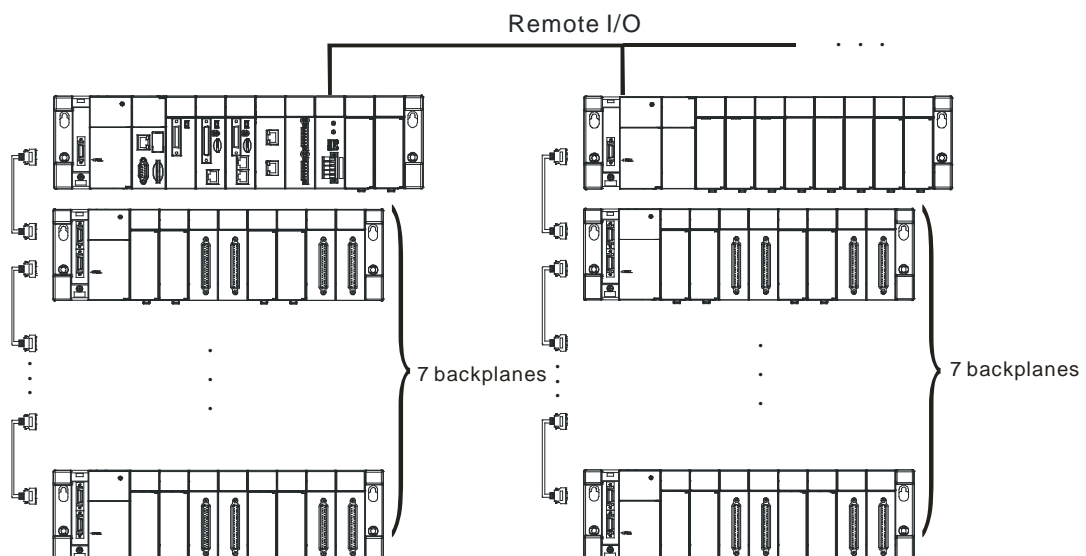



3. Multiple I/O modules

- The I/O modules supported by the AH500 series CPU module are digital input/output modules, analog input/output modules, temperature measurement modules, network modules, motion control modules, and RTU modules.

Module	Description
Digital input/output module	Digital input/output AH16AM10N-5A, AH32AM10N-5A, AH32AM10N-5B, AH32AM10N-5C, AH64AM10N-5C, AH16AM30N-5A, AH16AN01R-5A, AH16AN01T-5A, AH16AN01P-5A, AH32AN02T-5A, AH32AN02T-5B, AH32AN02T-5C, AH32AN02P-5A, AH32AN02P-5B, AH32AN02P-5C, AH64AN02T-5C, AH64AN02P-5C, AH16AN01S-5A, AH16AP11R-5A, AH16AP11T-5A, AH16AP11P-5A. and AH16AR10N-5A
Analog input/output module	Analog input/output AH04AD-5A, AH08AD-5A , AH08AD-5B, AH08AD-5C, AH04DA-5A, AH08DA-5A AH08DA-5B, AH08DA-5C, and AH06XA-5A
Temperature measurement module	Measuring the temperature AH04PT-5A, AH08PTG-5A, AH04TC-5A, and AH08TC-5A
Motion control module	Controlling the motion AH02HC-5A, AH04HC-5A, AH05PM-5A, AH10PM-5A, AH15PM-5A, and AH20MC-5A
Network module	Extending the communication interface (*There are multiple interfaces. All network modules can be installed on the main backplane except AH10SCM-5A and AH15SCM-5A.) AH10EN-5A, AH10SCM-5A, AH15SCM-5A, AH10DNET-5A, AH10PFBS-5A, AH10PFBM-5A, and AH10COPM-5A
Remote I/O module	It is installed on the main backplane as a remote terminal unit. (*It supports multiple communication interfaces.) AHRTU-DNET-5A , AHRTU-PFBS-5A, and AHRTU-ETHN-5A.

4. Larger program capacity and memory

- Program capacity
AH500 basic series CPU module (AHCPU500/510/520/530): 32/64/128/256K steps.
AH500 advanced series CPU module (AHCPU511/521/531): 96/192/384K steps.
Providing with a wider module selection for users to select a suitable CPU module according to their program capacity needs.
- Memory
AH500 basic series CPU module (AHCPU500/510/520/530): 16/32/64K words of memory and 64/256/512/1024 function blocks to be declared.
AH500 advanced series CPU module (AHCPU511/521/531): 48/96/128K words of memory and 1024/2048/4096 function blocks to be declared.

5. Devices which can be used conveniently in a program

- An AH500 series CPU module is equipped with devices which can be used conveniently in a program. Users can flexibly specify a bit in a word device, e.g. D0.0, X0.0, and Y0.0. Owing to that bits in a word device can be specified, these bits can function as contacts and coils.

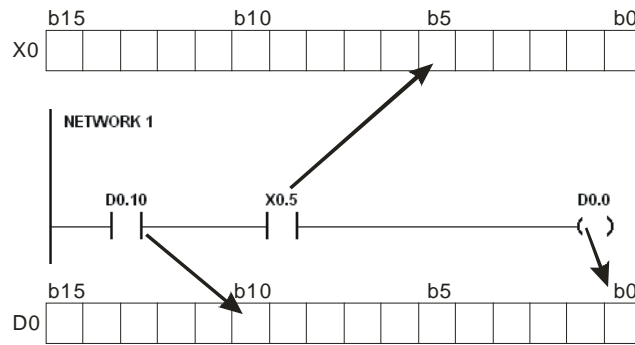

- Users can access the state of DX0.0 and that of DY0.0 in a program. The state of DX0.0 and that of DY0.0 are not limited by scan time. They are refreshed immediately in a program.



6. Supporting IEC 61131-3

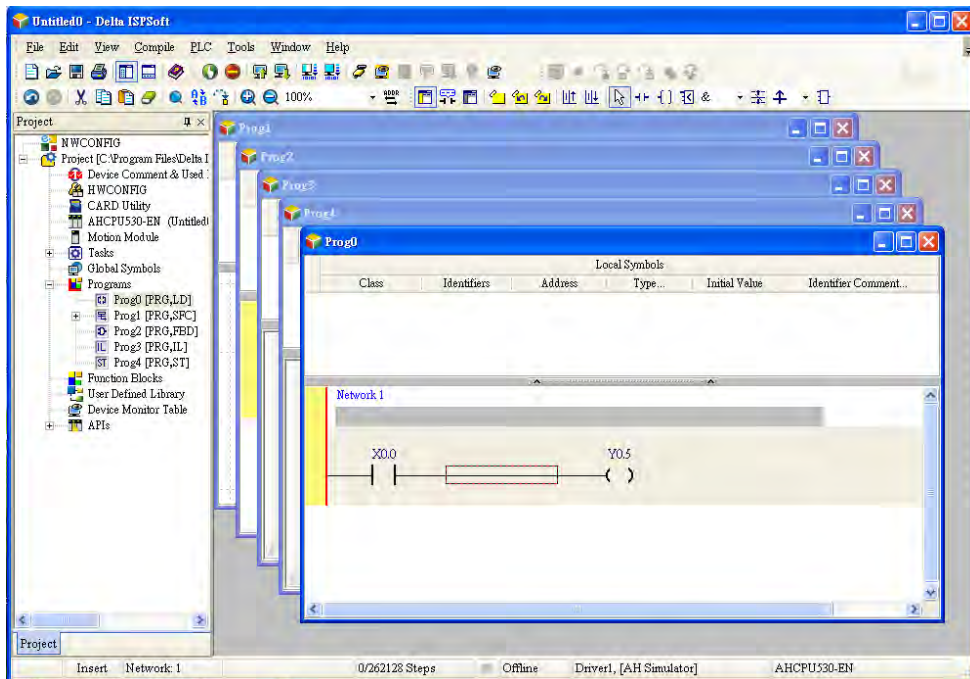

- The AH500 series CPU module supports IEC 61131-3.
- The programming languages which are supported are instruction lists (IL), structured texts (ST), ladder diagrams (LD), sequential function charts (SFC), and function block diagrams (FBD).

1

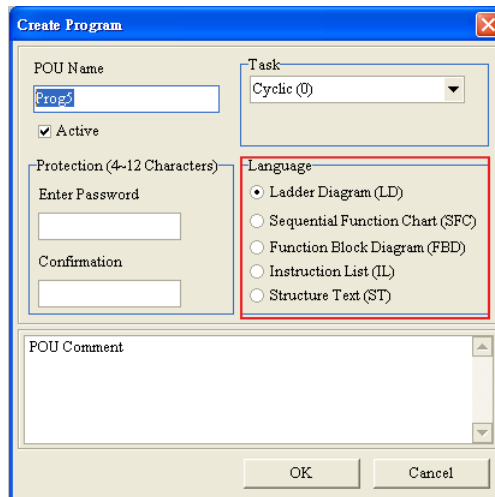

- Users can select a programming language according to their preference and the convenience. The programming languages support one another so that the programs written by different users are related.

7. Strong function block

- Not only the standard IEC61131-3 function blocks are supported, but also the convenient function blocks provided by Delta Electronics, Inc. are supported. Users can write the program frequently executed in a function block so that the program becomes more structured and can be executed more conveniently.
- The symbol for a function block in a ladder diagram is like an Integrated circuit (IC) in a circuit diagram. Owing to the fact that the ladder diagram is based on the traditional circuit diagram, the operation of a function block is quite similar to the function of an integrated circuit. Users only need to send the signal to the corresponding input of the function block, and they can receive the signal or state which is required. During the whole process, users do not need to consider the processing procedure inside the function block.

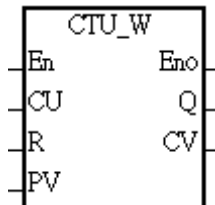

- A function block is a program element equipped with the operation function. It is similar to a subroutine, and is a type of POU (Program Organization Unit). It can not operate by itself, and has to be called through the program POU. After the related parameters are transmitted, the function defined by a function block is executed. Besides, the final operation result can be sent to the device or variable used in the superior POU after the execution of the function block is complete.
- The setting of passwords by means of ISPSOft provides the secrecy of function blocks for special businesses. The program inside a function block can not be learned, and the patent of a business will not be infringed.

8. Task

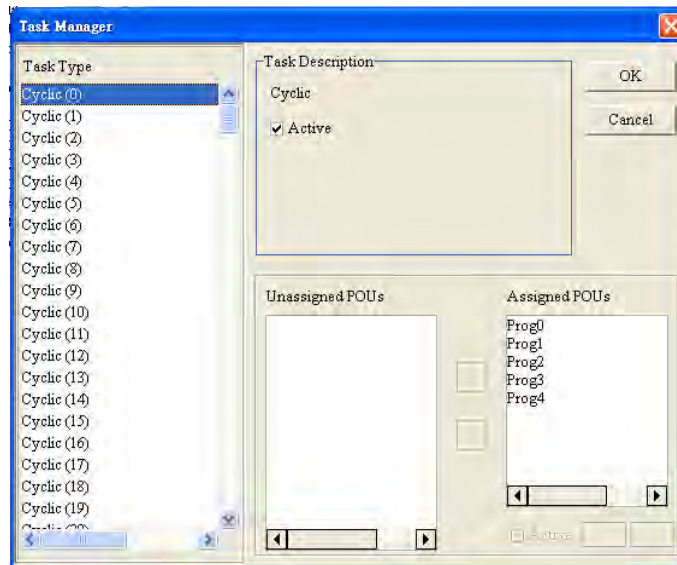

1

- The programs can be assigned to 283 tasks at most. Among the 288 tasks, 32 tasks are cyclic tasks, 32 tasks are I/O interrupts, 4 tasks are timer interrupts, 2 tasks are communication interrupts, 1 task is an external 24 V low-voltage interrupt, and 212 tasks are user-defined tasks.
- Users can enable and disable a task during the execution of a program by means of TKON and TKOFF.

1

9. Increasing the efficiency of configuring the hardware through a USB cable and ISPSOft

- The AH500 series CPU module provides a standard USB 2.0 interface. USB 2.0 increases the data transfer rate, and decreases the time it takes to download the program, monitor the program and configure the hardware. Besides, users do not need to buy a communication cable for the CPU module. They can use a general USB cable to connect to the AH500 series CPU module.

10. Serial control interface with multiple functions

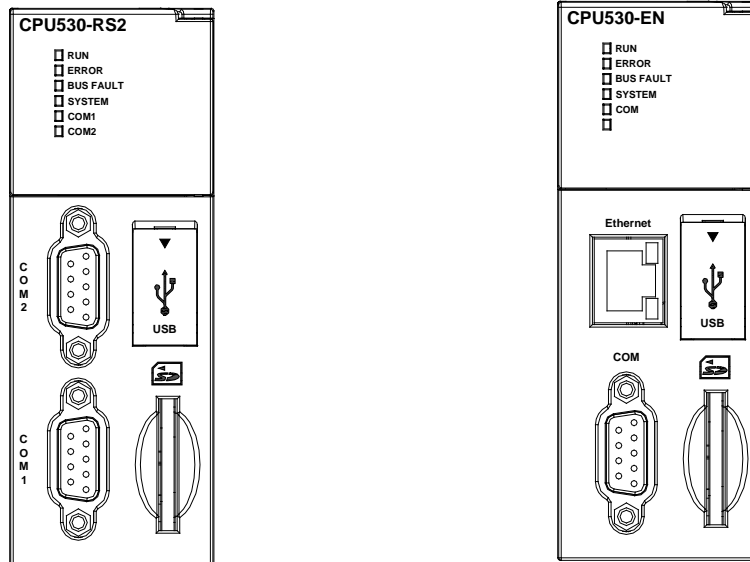

- AHCPU500/510/511/520/530-RS2 provides two DB9 serial control interfaces, i.e. COM1 and COM2.
- AHCPU500/510/511/520/521/530/531-EN provides one DB9 serial control interface, i.e. COM.
- Users can set the DB9 serial control interface to RS-232, RS-485, or RS-422 according to the application environment. The data transfer rate can be increased from 9600 bps to 1 Mbps.
- AH500 basic series CPU module (AHCPU500/510/520/530): After users set the PLC Link in NWCONIFG in ISPSOft, they can exchange the data with a device through the RS-485 serial control interface, and do not need to write any program.
- AH500 advanced series CPU module (AHCPU511/521/531): After users set the PLC Link in HWCONIFG in ISPSOft, they can exchange the data with a device through the RS-485 serial control interface, and do not need to write any program.

11. High-speed Ethernet communication interface

- AHCPU500/510/511/520/521/530/531-EN is equipped with a 10/100 M Ethernet communication interface, and supports emails, webs, and socket services.
- AH500 basic series CPU module (AHCPU500/510/520/530): After users set the PLC Link in NWCONIFG in ISPSOft, they can exchange the data with a device network through the Ethernet communication interface, and do not need to write any program.
- AH500 advanced series CPU module (AHCPU511/521/531): After users set the PLC Link in HWCONIFG in ISPSOft, they can exchange the data with a device through the Ethernet communication interface, and do not need to write any program.
- The status or the error message related to the system is sent to users' email boxes immediately. Users do not need to be on the spot to understand the problem.

12. Memory card

- The memory card has the following functions.
 System backup: The user program, the CPU parameters, the module table, the setting value in the device
 System recovery: The user program, the CPU parameters, the module table, and the setting value in the device
 Parameter storage: The value in the device
 Log storage: The system error log and the system status log

13. Hot swap

- The AH500 series I/O modules support the on-line uninterruptible hot swap. When the system runs, users can replace the module which breaks down without disconnecting the module. After the module is replaced, the new module runs normally. Users do not need to set the module manually or switch the state.



14. Supporting the on-line debugging mode

- After a single instruction step has been complete, or after a breakpoint is specified, users can easily find the bug in the program by means of the on-line debugging mode supported by the AH500 series CPU module.
 - If users want to enter the debugging mode, the CPU module must run. After users enable the on-line monitoring function, they have to click . The debugging screen varies from programming language to programming language, but the same operation applies to these programming languages. For the AH500 series PLC, structured texts do not support the debugging mode, and sequential function charts support the debugging mode during the action and the transition.
- Step 1: Setting the PLC to RUN

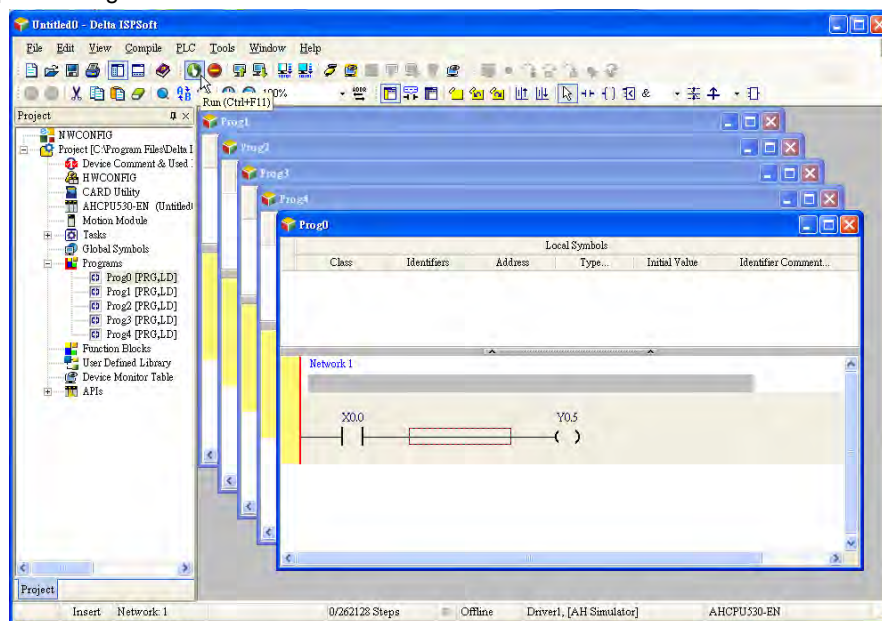

1

Step 2: Entering the on-line mode

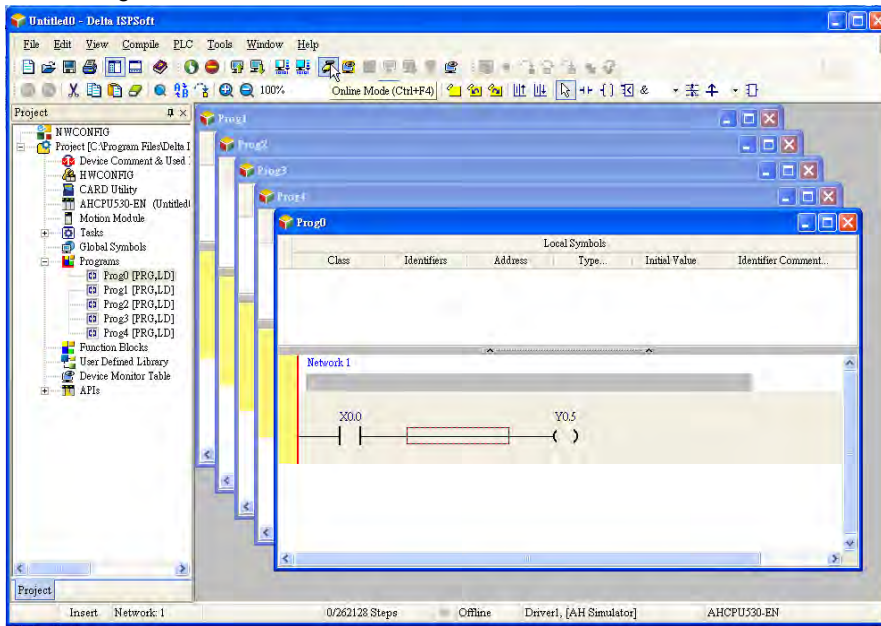

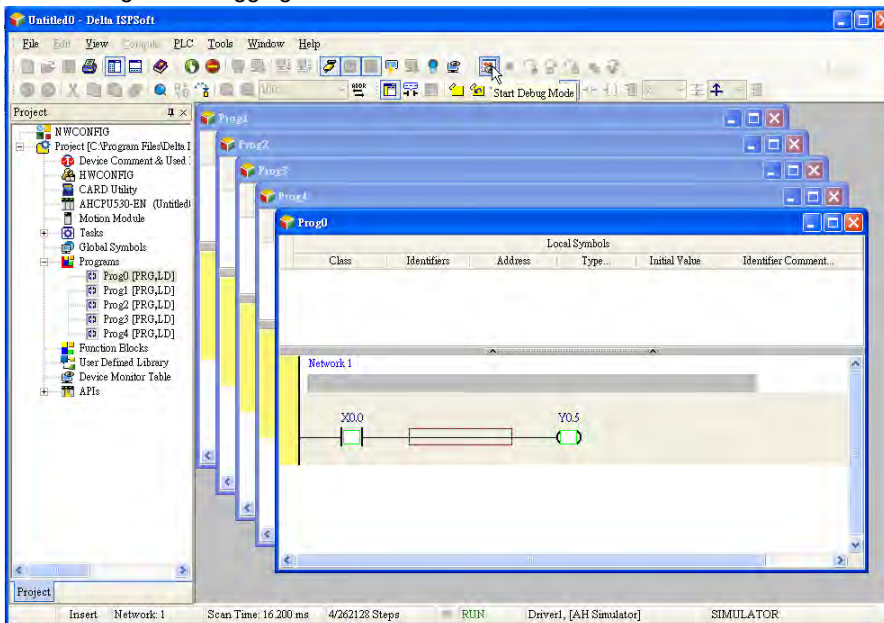

Step 3: Entering the debugging mode

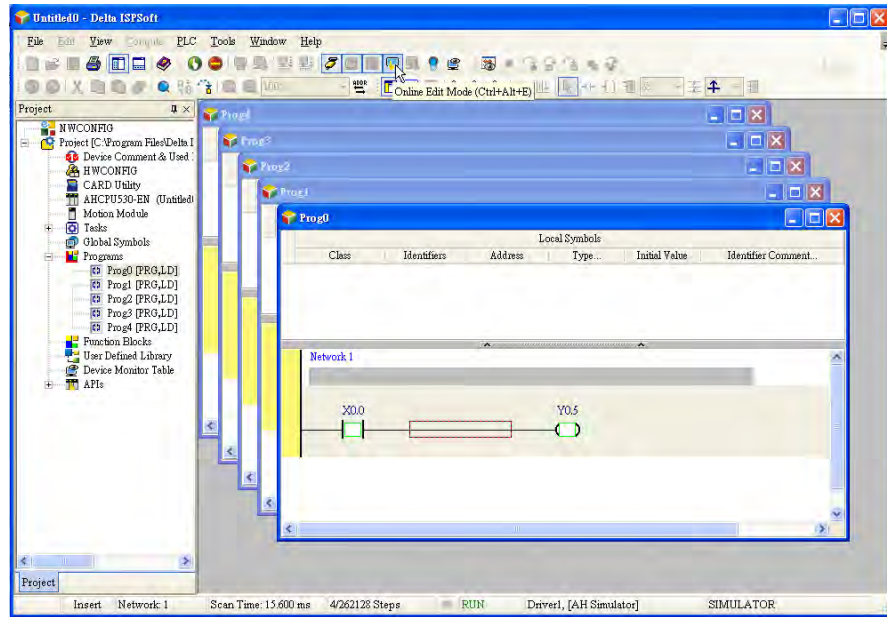

15. Supporting the on-line editing mode

- When the system runs, users can make use of the on-line editing mode to update the program without affecting the operation of the system.
- When the system is in the on-line monitoring mode, users can enter the on-line editing mode by clicking .



- After the program is modified and compiled, users can update the program in the CPU module by clicking .

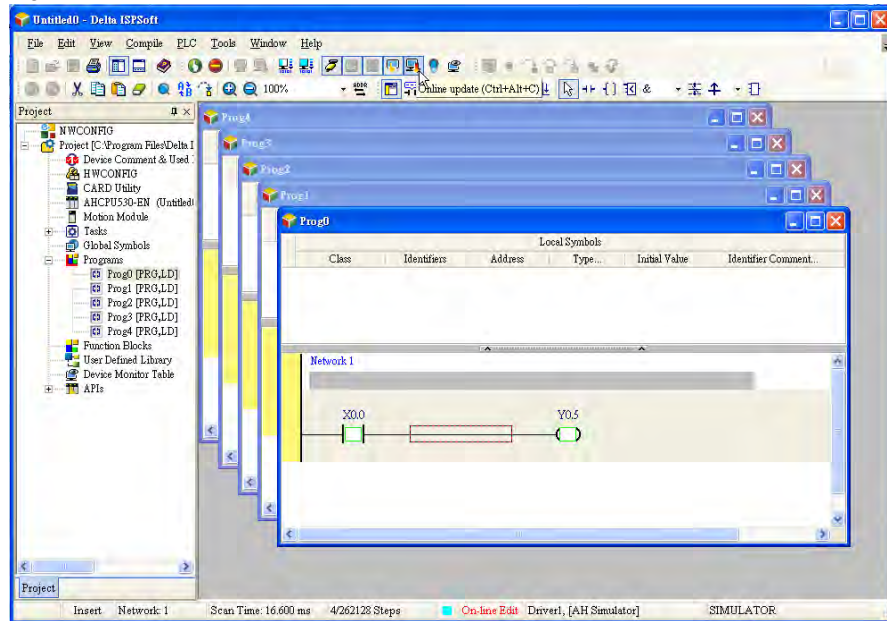

2

Chapter 2 Specifications and System Configuration

Table of Contents

2.1	General Specifications	2-3
2.2	Specifications for CPU Modules	2-3
2.2.1	Performance Specifications	2-3
2.2.2	Profiles	2-6
2.3	Basic System Configuration	2-8
2.3.1	Introduction	2-8
2.3.2	Configuring a Main Backplane	2-9
2.3.3	Configuring an Extension Backplane	2-9
2.3.4	Maximum Extension	2-9
2.4	Specifications for Digital Input/Output Modules	2-10
2.4.1	General Specifications	2-10
2.4.2	Profiles	2-13
2.4.3	Dimensions	2-21
2.4.4	Arrangement of Input/Output Terminals	2-26
2.5	Specifications for Analog Input/Output Modules	2-34
2.5.1	General Specifications	2-34
2.5.2	Profiles	2-39
2.5.3	Dimensions	2-40
2.5.4	Arrangement of Input/Output Terminals	2-42
2.5.5	Setting Parameters	2-44
2.6	Specifications for Temperature Measurement Modules	2-47
2.6.1	General Specifications	2-47
2.6.2	Profiles	2-49
2.6.3	Dimensions	2-50
2.6.4	Arrangement of Input/Output Terminals	2-51
2.6.5	Setting Parameters	2-52
2.7	Specifications for Network Modules	2-54
2.7.1	General Specifications	2-54
2.7.2	Profiles	2-57
2.7.3	Dimensions	2-65
2.7.4	Arrangement of Input/Output Terminals	2-68
2.7.5	Setting Parameters	2-69
2.8	Specifications for Motion Control Modules	2-72
2.8.1	General Specifications	2-72
2.8.2	Profiles	2-83
2.8.3	Dimensions	2-89
2.8.4	Arrangement of Input/Output Terminals	2-92
2.8.5	Setting Parameters	2-97
2.9	Specifications for Remote Input/Output Modules	2-99
2.9.1	General Specifications	2-99
2.9.2	Profiles	2-100
2.9.3	Dimensions	2-104
2.10	Specifications for Power Supply Modules	2-106
2.10.1	General Specifications	2-106
2.10.2	Profiles	2-107
2.10.3	Dimensions	2-108
2.10.4	Arrangement of Terminals	2-109
2.11	Space Module, Backplanes, and Extension Cables	2-110

2.11.1 General Specifications.....2-110
2.11.2 Profiles2-111
2.11.3 Dimensions.....2-114

2.1 General Specifications

Item	Specifications
Operating temperature	-20~60°C
Storage temperature	-40~70°C
Operating humidity	5~95% No condensation
Storage humidity	5~95% No condensation
Vibration/Shock resistance	International standards IEC 61131-2, IEC 68-2-6 (TEST Fc)/ IEC 61131-2 & IEC 68-2-27 (TEST Ea)
Work environment	No corrosive gas exists.
Installation location	In a control box
Pollution degree	2

2.2 Specifications for CPU Modules

2.2.1 Performance Specifications of AH500 basic series

Item	AHCPU500/510/520/530 -RS2	AHCPU500/510/520/530 -EN	Remark
Execution	The program is executed cyclically.		
Input/Output control	Regenerated inputs/outputs Direct inputs/outputs		The inputs and outputs can be controlled through the direct inputs and direct outputs.
Programming language	IEC 61131-3 Ladder diagrams, function block diagrams, instruction lists, structured texts, and sequential function charts		
Instruction execution speed	3K Steps/ms		
Number of instructions	Approximately 666 instructions		
Constant scan cycle (ms)	1-32000 (The scan cycle can be increased by one millisecond.)		Setting the parameter
Program capacity (step)	32K steps (AHCPU500) 64K steps (AHCPU510) 128K steps (AHCPU520) 256K steps (AHCPU530)		
Installation	DIN rails or screws		
Installation of a module	A module is installed directly on a backplane.		
Connection between two backplanes	An extension cable connects two backplanes.		
Maximum number of modules which can be installed	12 (AHCPU500) 20 (AHCPU510) 36 (AHCPU520) 68 (AHCPU530)		
Maximum number of backplanes which can be connected	AHCPU500: 1 backplane (1 main backplane) AHCPU510: 2 backplanes (1 main backplane+1 extension backplane) AHCPU520: 4 backplanes (1 main backplane+3 extension backplanes) AHCPU530: 8 backplanes (1 main backplane+7 extension backplanes)		
Number of tasks	283 tasks (32 cyclic tasks; 32 I/O interrupts; 4 timed interrupts; 2 communication interrupts; 1		

2

Item	AHCPU500/510/520/530 -RS2	AHCPU500/510/520/530 -EN	Remark
	external 24 V low-voltage interrupt; 212 external interrupts)		
Number of inputs/outputs	AHCPU500: 768 AHCPU510: 1280 AHCPU520: 2304 AHCPU530: 4352		Number of inputs/outputs accessible to an actual input/output module
Input relays [X]	AHCPU500: 1024 (X0.0~X63.15) AHCPU510: 2048 (X0.0~X127.15) AHCPU520: 4096 (X0.0~X255.15) AHCPU530: 8192 (X0.0~X511.15)		
Output relays [Y]	AHCPU500: 1024 (Y0.0~Y63.15) AHCPU510: 2048 (Y0.0~Y127.15) AHCPU520: 4096 (Y0.0~Y255.15) AHCPU530: 8192 (Y0.0~Y511.15)		
Internal relays [M]	8192 (M0~M8191)		
Link registers [L]	AHCPU500: 16384 (L0~L16383) AHCPU510: 32768 (L0~L32767) AHCPU520: 65536 (L0~L65535) AHCPU530: 65536 (L0~L65535)		
Timers [T]	2048 (T0~T2047)		
Counters [C]	2048 (C0~C2047)		
32-bit counter [HC]	64 (HC0~HC63)		
Data register [D]	AHCPU500:16384 (D0~D16383) AHCPU510: 32768 (D0~D32767) AHCPU520: 65536 (D0~D65535) AHCPU530: 65536 (D0~D65535)		
Stepping relay [S]	2048 (S0~S2047)		
Index register [E]	32 (E0~E31)		
Special auxiliary relay [SM]	2048 (SM0~SM2047)		
Special data register [SR]	2048 (SR0~SR2047)		
Serial communication port	Two RS-232/RS-485/RS-422 communication ports	One RS-232/RS-485/RS-422 communication port	
Ethernet port	-	10/100 M	
USB port	Mini USB		
Storage interface	SD Card (SD 1.0)		
Remote RUN/STOP	The setting range is X0.0~X511.15.		
Real-time clock	Years, months, days, hours, minutes, seconds, and weeks		

2.2.2 Performance Specifications of AH500 advanced series

Item	AHCPU511-RS2	AHCPU511/521/531 -EN	Remark
Execution	The program is executed cyclically.		
Input/Output control	Regenerated inputs/outputs Direct inputs/outputs		The inputs and outputs can be controlled through the direct inputs and direct outputs.
Programming language	IEC 61131-3		
	Ladder diagrams, function block diagrams, instruction lists, structured texts, and sequential function charts		

Item	AHCPU511-RS2	AHCPU511/521/531 -EN	Remark
Instruction execution speed	12K Steps/ms		
Number of instructions	Approximately 666 instructions		
Constant scan cycle (ms)	1-32000 (The scan cycle can be increased by one millisecond.)		Setting the parameter
Program capacity (step)	96K Steps (AHCPU511) 192K Steps (AHCPU521) 384K Steps (AHCPU531)		
Installation	DIN rails or screws		
Installation of a module	A module is installed directly on a backplane.		
Connection between two backplanes	An extension cable connects two backplanes.		
Maximum number of modules which can be installed	20 (AHCPU511) 36 (AHCPU521) 68 (AHCPU531)		
Maximum number of backplanes which can be connected	AHCPU511: 2 backplanes (1 main backplane+1 extension backplane) AHCPU521: 4 backplanes (1 main backplane+3 extension backplanes) AHCPU531: 8 backplanes (1 main backplane+7 extension backplanes)		
Number of tasks	283 tasks (32 cyclic tasks; 32 I/O interrupts; 4 timed interrupts; 2 communication interrupts; 1 external 24 V low-voltage interrupt; 212 external interrupts)		
Number of inputs/outputs	AHCPU511: 1280 AHCPU521: 2304 AHCPU531: 4352		Number of inputs/outputs accessible to an actual input/output module
Input relays [X]	AHCPU511: 4096 (X0.0~X255.15) AHCPU521: 8192 (X0.0~X511.15) AHCPU531: 8192 (X0.0~X1023.15)		
Output relays [Y]	AHCPU511: 4096 (Y0.0~Y255.15) AHCPU521: 8192 (Y0.0~Y511.15) AHCPU531: 8192 (Y0.0~Y1023.15)		
Internal relays [M]	8192 (M0~M8191)		
Link registers [L]	AHCPU511: 49152 (L0~L49151) AHCPU521: 98304 (L0~L98303) AHCPU531: 131072 (L0~L131071)		
Timers [T]	2048 (T0~T2047)		
Counters [C]	2048 (C0~C2047)		
32-bit counter [HC]	64 (HC0~HC63)		
Data register [D]	AHCPU500:16384 (D0~D16383) AHCPU510: 32768 (D0~D32767) AHCPU520: 65536 (D0~D65535) AHCPU530: 65536 (D0~D65535)		
Stepping relay [S]	2048 (S0~S2047)		
Index register [E]	32 (E0~E31)		
Special auxiliary relay [SM]	AHCPU511/521/531-EN : 2048 (SM0~SM2047) AHCPU511-RS2: 4096 (SM0~SM4095)		
Special data register [SR]	AHCPU511/521/531-EN: 2048 (SR0~SR2047) AHCPU511-RS2: 4096 (SR0~SR4095)		
Serial communication port	Two RS-232/RS-485/RS-422	One RS-232/RS-485/RS-422	

2

Item	AHCPU511-RS2	AHCPU511/521/531 -EN	Remark
	communication ports	communication port	
Ethernet port	-	10/100 M	
USB port	Mini USB		
Storage interface	SD Card (SD 2.0)		
Remote RUN/STOP	The setting range is X0.0~X511.15.		
Real-time clock	Years, months, days, hours, minutes, seconds, and weeks		

2.2.3 Profiles

An AH500 system can be configured by setting the following communication ports.

- Three built-in communication ports in AHCPU500-EN/AHCPU510-EN/AHCPU511-EN/AHCPU520-EN/AHCPU521-EN /AHCPU530-EN/AHCPU531-EN: An USB port, an RS-232C/RS-422A/RS-485 port, and an Ethernet port

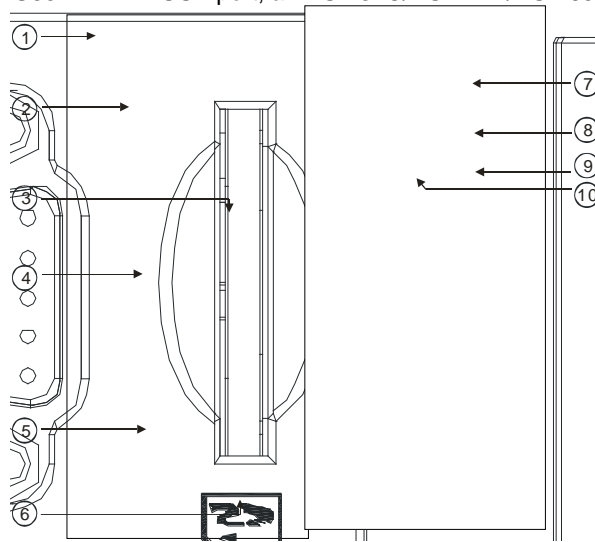

- Two built-in communication ports in AHCPU500-RS2/AHCPU510-RS2/ AHCPU511-RS2/AHCPU520-RS2/AHCPU530-RS2: An RS-232C port and an RS-422A/RS-485 port

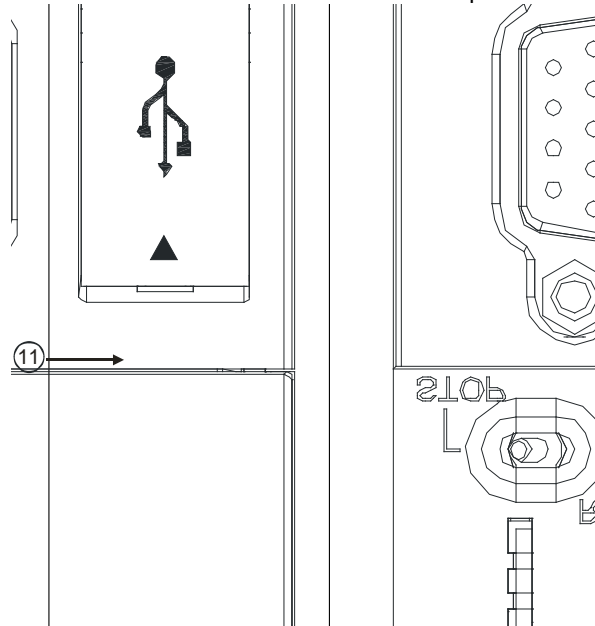

1. Model name	2. LED indicator	3. USB port
4. Ethernet port (for AHCPU5xx-EN)	5. COM	6. SD slot

7. DIP switch	8. RST button	9. CLR button
10. RUN/STOP switch	11. COM2 (for AHCPU5xx-RS2)	

Number	Name	Description	
1	Model name	Model name of the CPU module	
2	RUN LED indicator	Operating status of the CPU module ON: The user program is being executed. OFF: The execution of the user program stops. Blinking: The user program is in a debugging mode.	
	ERROR LED indicator	Error status of the CPU module ON: A serious error occurs in the system. OFF: The system is normal. Blinking: A slight error occurs in the system.	
	BUS FAULT LED indicator	Error status of the I/O bus ON: A serious error occurs in the I/O bus. OFF: The I/O bus is normal. Blinking: A slight error occurs in the I/O bus.	
	SYSTEM LED indicator	System status of the CPU module ON: The external input/output is forced ON/OFF. OFF: The system is in a default status. Blinking: The CPU module is being reset./The value in the device is being cleared.	
	COM LED indicator COM1 LED indicator COM2 LED indicator	Communication status of the communication port OFF: There is no communication through the communication port. Blinking: There is communication through the communication port.	
3	USB port	Providing the mini USB communication interface	
4	Ethernet port	Providing the Ethernet communication interface (for AHCPU5xx-EN)	
5	COM	Providing the RS-232/RS-485/RS-422 communication interface	
6	SD slot	Providing the SD interface	
7	DIP switch	Function which the system executes	
		SW1	OFF: No action (default) ON: Write protection
		SW2	OFF: No action (default) ON: The system is restored when the CPU module is supplied with powered. (The user program, the CPU paramter, the module table, and the setting values in the devices are restored from the memory card to the CPU module.)
		SW3	OFF: No action (default) ON: It is used with the CLR button to backup the system. (The user program, the CPU paramter, the module table, and the setting values in the devices are backed up from the memory card to the CPU module.)
		SW4	It is used with SW3. OFF: When the system is backed up, the values in the devices are backed up. ON: When the system is backed up, the values in the devices are not backed up.
8	RST button	Resetting the CPU module, and restoring it to the default factory value P.S. After the CPU module is reset, the ERROR LED indicator is ON, and the error code 16#1402 is shown. To make the PLC operate normally, users need to execute ISPSOFT.exe to set the module table in HWCONFIG.	
9	CLR button	Clearing the value in the latched device	

Number	Name	Description
10	RUN/STOP switch	RUN: The user program is executed. STOP: The execution of the user program stops.
11	COM1/COM2	Providing the RS-232/RS-485/RS-422 communication interface (for AHCPU5xx-RS2)

2.3 Basic System Configuration

2.3.1 Introduction

The AH500 system configuration is composed of a CPU module, power supply modules, digital input/output modules, analog input/output modules, temperature measurement modules, network modules, motion control modules, a main backplane, extension cables, and extension backplanes. Besides, an SD card is optionally used.

A main backplane can be connected to an extension backplane through the interface on the left side of the main backplane, the interface on the left side of the extension backplane, and a Delta extension cable. For a CPU module or a RTU, a main backplane can be connected to seven extension backplanes at most through the interfaces on the backplanes. Therefore, if there is a CPU module and there are several RTUs, not only the CPU module can be connected to seven extension backplanes, but also every RTU can connect to seven extension backplanes.

There are two ports on an extension backplane. The upper port is used to connect to a superior backplane, and the lower port is used to connect to an inferior backplane.

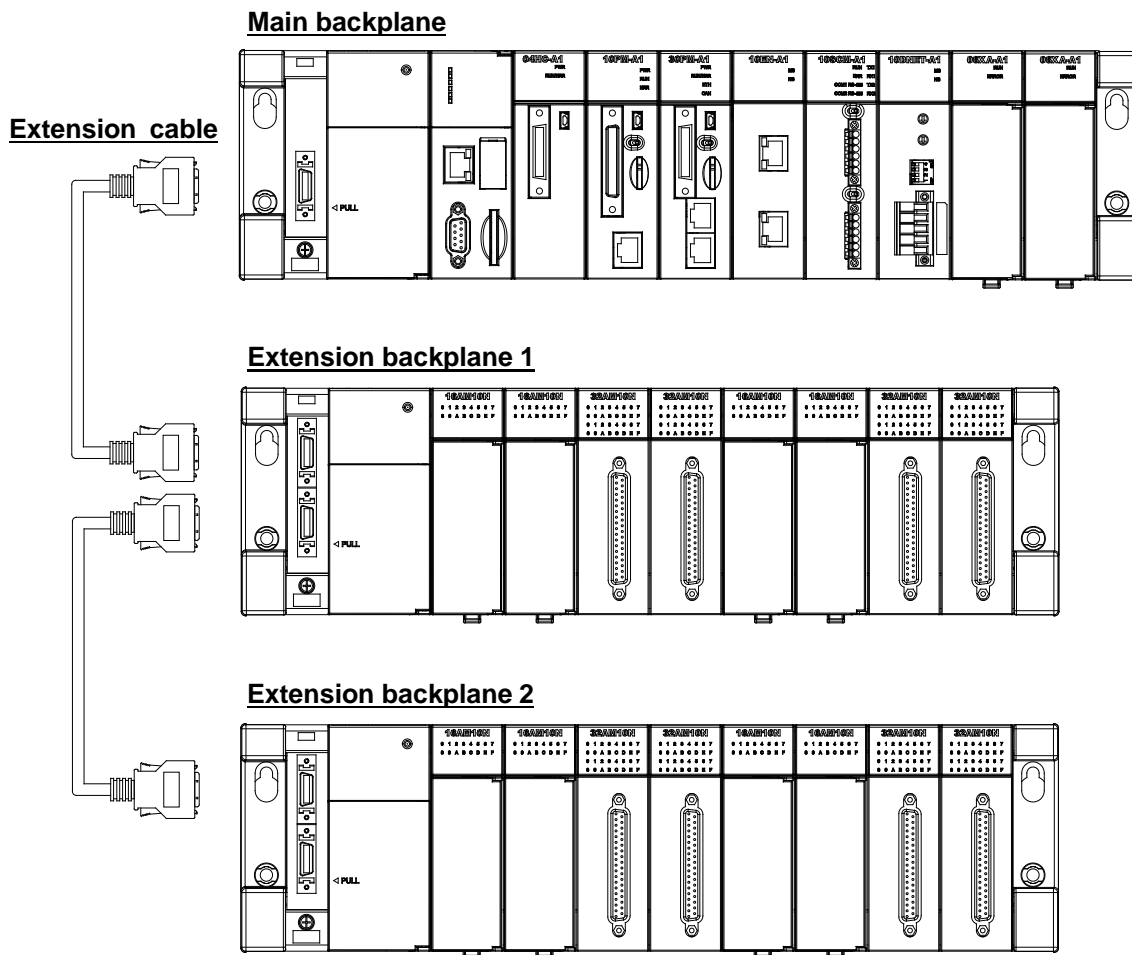

2.3.2 Configuring a Main Backplane

A CPU module, a power supply module, and I/O modules are installed on a main backplane. Twelve I/O modules at most can be installed on a main backplane.

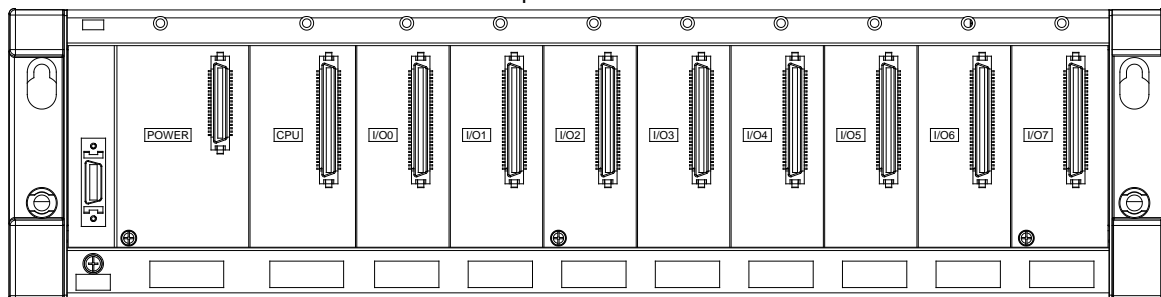

2

2.3.3 Configuring an Extension Backplane

An extension backplane can be connected to a main backplane to increase the number of I/O modules. Eight I/O modules at most can be installed on an extension cable, and seven extension backplanes at most can be connected to a main backplane.

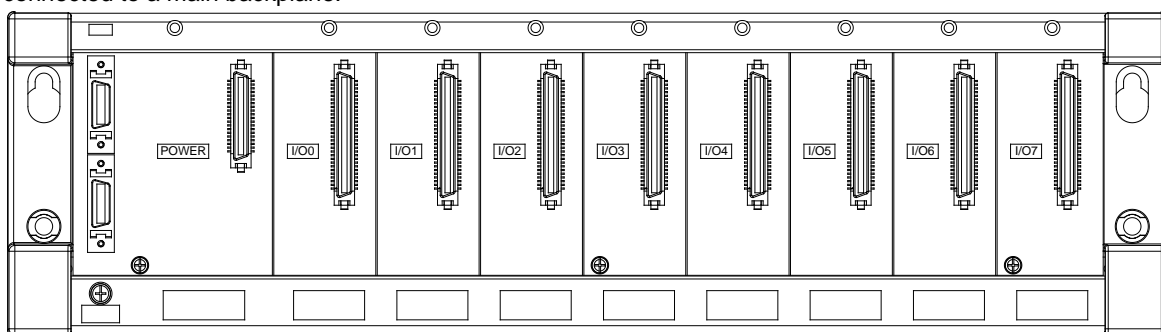

2.3.4 Maximum Extension

Twelve I/O modules at most can be installed on a main backplane. (There are four types of main backplanes. These four types are four-slot main backplanes, six-slot main backplanes, eight-slot main backplanes, and twelve-slot main backplanes.) Eight I/O modules at most can be installed on an extension backplane, and seven extension backplanes at most can be connected to a main backplane. (There are two types of extension backplanes. These two types are six-slot extension backplanes, and eight-slot extension backplanes.) Sixty-eight I/O modules at most can be installed on backplanes. Eight AH10EN-5A modules at most can be installed on a main backplane, and eight AH10DNET-5A modules at most can be installed on a main backplane. The other I/O modules can be installed on a main backplane unlimitedly. Besides, digital input/output modules, analog input/output modules, temperature measurement modules, and AH10SCM-5A modules can be installed on an extension backplane. The other I/O modules can not be installed on an extension backplane.

Extension	Maximum Extension	Description
A main backplane is connected to extension backplanes	One main backplane and seven extension backplanes (There are four types of main backplanes. These four types are four-slot main backplanes, six-slot main backplanes, eight-slot main backplanes, and twelve-slot main backplanes. There are two types of extension backplanes. These two types are six-slot extension backplanes, and eight-slot extension backplanes.)	Sixty-eight I/O modules at most can be installed on backplanes.

2

- AH500 system configuration

Configuration	Description
Main backplane	There is one main backplane in an AH500 system. Four-slot main backplane: AHBP04M1-5A Six-slot main backplane: AHBP06M1-5A Eight-slot main backplane: AHBP08M1-5A Twelve-slot main backplane: AHBP12M1-5A
Extension backplane	There are seven extension backplanes at most in an AH500 system. Six-slot extension backplanes: AHBP06E1-5A Eight-slot extension backplanes: AHBP08E1-5A
Extension cable	There are four types of lengths. AHACAB06-5: 60 cm AHACAB10-5A: 1 m AHACAB15-5A: 1.5 m AHACAB30-5A: 3 m
Power supply module	Every backplane needs a power supply module. (The voltages of the alternating currents which can flow into AHPS05-5A range from 85 V to 264 V, and the direct currents which can flow from AHPS05-5A are 5 A. AHPS05-5A is used with a backplane. The voltages of the direct currents which can flow into AHPS15-5A are 24 V, and the direct currents which can flow from AHPS15-5A are 1.5 A.)
CPU module	There is one CPU module in an AH500 system. AHCPU530-RS2 and AHCPU530-EN CPU modules.
Digital I/O module	Digital I/O modules, analog I/O modules, and temperature measurement modules can be installed in an AH500 system unlimitedly.
Analog I/O module	
Temperature measurement module	
Motion control module	
Network module	Motion control modules can only be installed on a main backplane. Network modules can only be installed on a main backplanes. Eight AH10EN-5A modules at most can be installed on a main backplane, and eight AH10DNET-5A modules at most can be installed on a main backplane. However, AHSCM-5A modules can be installed on a main backplane unlimitedly.

2.4 Specifications for Digital Input/Output Modules

2.4.1 General Specifications

- Electrical specifications for the inputs on digital input/output modules (The signals passing through the inputs are 24 V DC signals.)

		Model								
		AH16AM10N	AH32AM10N	AH32AM10N	AH32AM10N	AH64AM10N	AH16AP11R	AH16AP11T	AH16AP11P	
Item		-5A	-5A	-5B	-5C	-5C	-5A	-5A	-5A	
Number of inputs		16	32	32	32	64	8	8	8	
Connector type		Removable terminal block		DB37 connector	Latch connector		Removable terminal block			
Input type		Digital input								
Input form		Direct current (sinking or sourcing)								
Input current		24 V DC 5 mA				24 V DC 3.2 mA	24 V DC 5 mA			
Action level	OFF→ON	>15 V DC								
	ON→OFF	<5 V DC								
Response time	OFF→ON	10 ms±10%								
	ON→OFF	15 ms±10%								
Maximum input frequency		50 Hz								

Item	Model	AH16AM10N	AH32AM10N	AH32AM10N	AH32AM10N	AH64AM10N	AH16AP11R	AH16AP11T	AH16AP11P
		-5A	-5A	-5B	-5C	-5C	-5A	-5A	-5A
Input impedance		4.7 k Ω				7.5 k Ω	4.7 k Ω		
Input signal		Voltage input Sinking: The inputs are NPN transistors whose collectors are open collectors. Sourcing: The inputs are PNP transistors whose collectors are open collectors.							
Electrical isolation		Optocoupler							
Input display		When the optocoupler is driven, the input LED indicator is ON.							

- Electrical specifications for the inputs on a digital input/output module (The signals passing through the inputs are alternating current signals ranging in voltage from 120 V to 240 V.)

Model		AH16AM30N-5A				
Number of inputs		16				
Connector type		Removable terminal block				
Input type		Digital input				
Input form		Alternating current				
Input current		120 V AC and 4.5 mA; 240 V AC and 9 mA				
Action level	OFF→ON	>79 V AC				
	ON→OFF	<40 V AC				
Response time	OFF→ON	15 ms				
	ON→OFF	30 ms				
Electrical isolation		Optocoupler				
Input display		When the optocoupler is driven, the input LED indicator is ON.				

- Electrical specifications for the inputs on a digital input/output module which supports I/O interrupts (The signals passing through the inputs are 24 V DC signals.)

Model		AH16AR10N-5A				
Number of inputs		16				
Input power form		Direct current				
Connector type		Removable terminal block				
Input type		Digital input				
Input form		Direct current (sinking or sourcing)				
Input current		24 V DC, 5 mA				
Action level	OFF→ON	>15 V DC				
	ON→OFF	<5 V DC				
Response time	Filtering cycle	0.1 ms	0.5 ms	3 ms	15 ms	20 ms
	OFF→ON (Typical)	0.11 ms	0.51 ms	3.01 ms	15.01 ms	20.01 ms
	OFF→ON (Maximum)	0.12 ms	0.52 ms	3.02 ms	15.02 ms	20.02 ms
	ON→OFF (Typical)	0.11 ms	0.51 ms	3.01 ms	15.01 ms	20.01 ms
	ON→OFF (Maximum)	0.15 ms	0.55 ms	3.05 ms	15.05 ms	20.05 ms
Input impedance		ON→OFF				
Input signal		Voltage input Sinking: The inputs are NPN transistors whose collectors are open collectors. Sourcing: The inputs are PNP transistors whose collectors are open collectors.				
Electrical isolation		Optocoupler				
Input display		When the optocoupler is driven, the input LED indicator is ON.				
Trigger for an interrupt		An interrupt is triggered when there is a transition in a signal from low to high/from high to low/from low to high or from high to low.				

2

Item	Model	AH16AR10N-5A
Interrupt service routine		The interrupt service routine numbers which can be set are in the range of 0 to 31.
Filtering cycle which can be set for an input channel		0.1 ms, 0.5 ms, 3 ms (default), 15 ms, or 20 ms

● Electrical specifications for the outputs on digital input/output modules

Model		AH16AN01R	AH16AP11R	AH16AN01T	AH16AP11T	AH16AN01P	AH16AP11P	AH16AN01S
Item		-5A	-5A	-5A	-5A	-5A	-5A	-5A
Number of outputs		16	8	16	8	16	8	16
Connector type		Removable terminal block						
Output type		Relay-R		Transistor-T (sinking)		Transistor-P (sourcing)		TRIAC-S
Voltage specifications		250 V AC, and below 30 V DC		12~30 V DC ^{*2}		12~30 V DC ^{*2}		120/240 V AC
Maximum load	Resistance	2 A/output (5 A/COM)		0.5 A/output (4 A/COM)		0.5 A/output (4 A/COM)		0.5 A/output (2 A/COM)
	Inductance	Life cycle curve ^{*3}		12 W (24 V DC)		12 W (24 V DC)		Not applicable
	Bulb	20 W (24 V DC) 100 W (230 V AC)		2 W (24 V DC)		2 W (24 V DC)		60 W AC
Maximum output frequency ^{*1}	Resistance	1 Hz		100 Hz		100 Hz		10 Hz
	Inductance	0.5 Hz		0.5 Hz		0.5 Hz		-
	Bulb	1 Hz		10 Hz		10 Hz		10 Hz
Maximum Response time	OFF→ON	10 ms		0.5 ms		0.5 ms		1 ms+0.5 AC cycles
	ON→OFF							

Model		AH32AN02T	AH32AN02P	AH32AN02T	AH32AN02P	AH32AN02T	AH32AN02P	AH64AN02T	AH64AN02P
Item		-5A	-5A	-5B	-5B	-5C	-5C	-5C	-5C
Number of outputs		32	32	32	32	32	32	64	64
Connector type		Removable terminal block		DB37 connector		Latch connector			
Output type		Transistor-T (sinking) Transistor-P (sourcing)							
Voltage specifications		12~30 V DC ^{*2}							
Maximum load	Resistance	0.1 A/output (1 A/COM)							
	Inductance	Not applicable							
	Bulb	Not applicable							
Maximum output frequency ^{*1}	Resistance	100 Hz							
	Inductance	-							
	Bulb	-							
Maximum Response time	OFF→ON	0.5 ms							
	ON→OFF								

*1: The scan cycle affects the frequency.

*2: The terminals UP and ZP needs to be connected to the 24 V DC auxiliary power supply (-15%~+20%), and the rated current consumption is 1 mA/output.

*3: The life cycle curve is shown below.

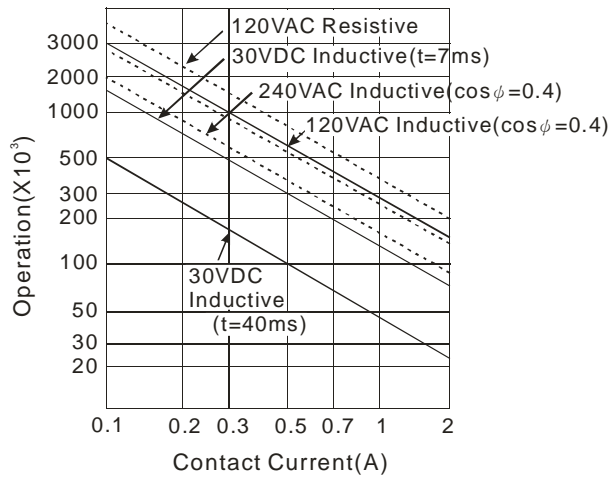

2

2.4.2 Profiles

- AH16AM10N-5A/AH16AM30N-5A/AH16AR10N-5A/AH16AN01S-5A/AH16AN01R-5A/AH16AN01T-5A/AH16AN01P-5A/AH16AP11R-5A/AH16AP11T-5A/AH16AP11P-5A

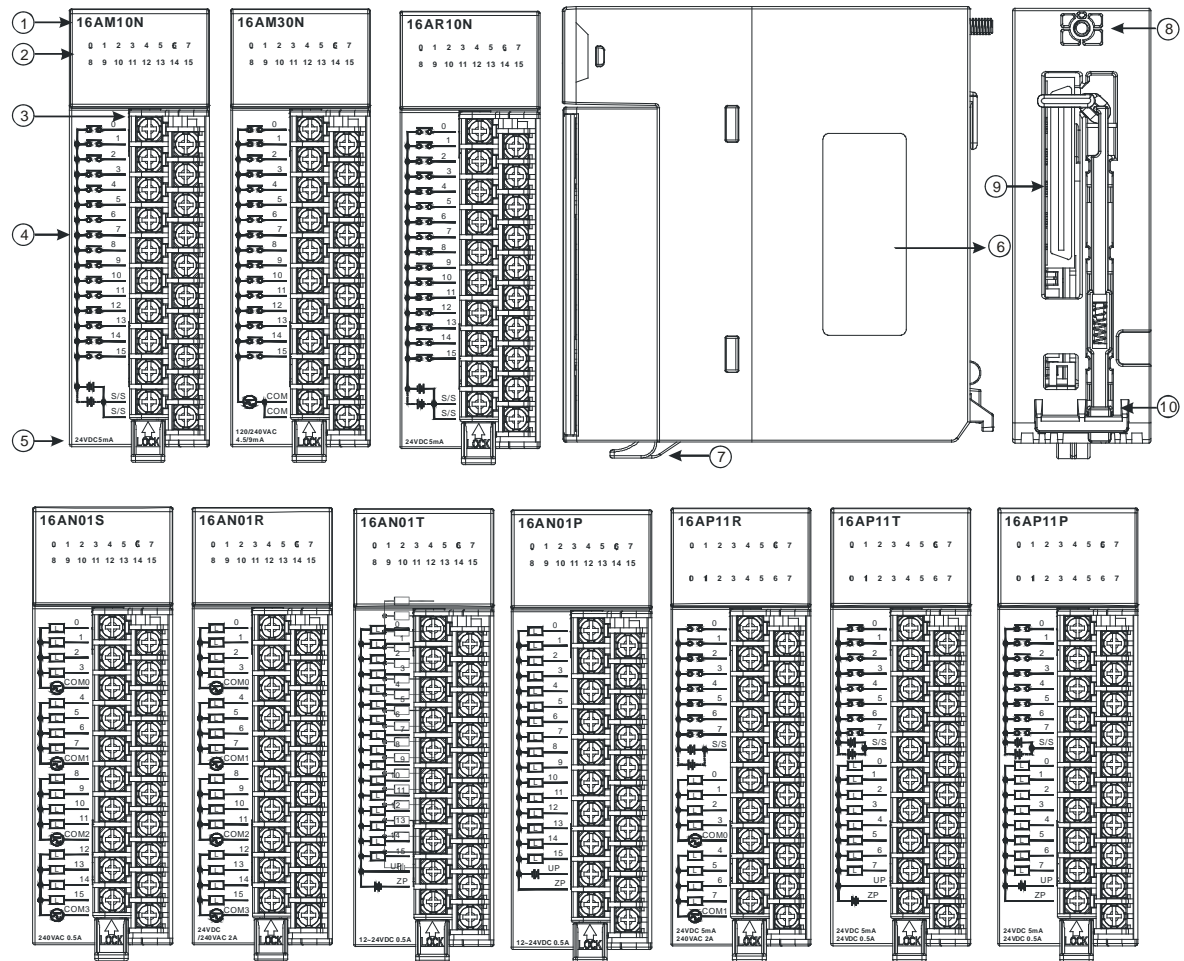

Number	Name	Description
1	Model name	Model name of the module
2	Input/Output LED indicator	If there is an input signal, the input LED indicator is ON. If there is an output signal, the output LED indicator is ON.
3	Removable	The inputs are connected to a switch or a sensor.

2

Number	Name	Description
	terminal block	The outputs are connected to a load which will be driven, e.g. a contact, or a solenoid valve.
4	Arrangement of the input/output terminals	Arrangement of the terminals
5	Description of the inputs/outputs	Number of inputs/outputs and specifications
6	Label	Nameplate
7	Clip	Fixing the removable terminal block
8	Set screw	Fixing the module
9	Connector	Connecting the module and a backplane
10	Projection	Fixing the module

● AH32AM10N-5A/AH32AN02T-5A/AH32AN02P-5A

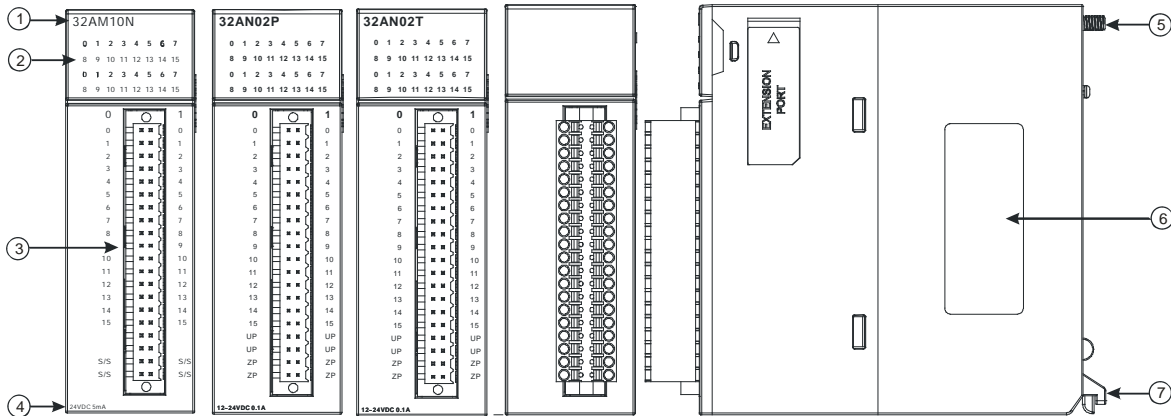

Number	Name	Description
1	Model name	Model name of the module
2	Input/Output LED indicator	If there is an input signal, the input LED indicator is ON. If there is an output signal, the output LED indicator is ON.
3	Removable terminal block	The inputs are connected to a switch or a sensor. The outputs are connected to a load which will be driven, e.g. a contact, or a solenoid valve.
4	Description of the inputs/outputs	Number of inputs/outputs and specifications
5	Set screw	Fixing the module
6	Label	Nameplate
7	Projection	Fixing the module

● AH32AM10N-5B/AH32AN02T-5B/AH32AN02P-5B

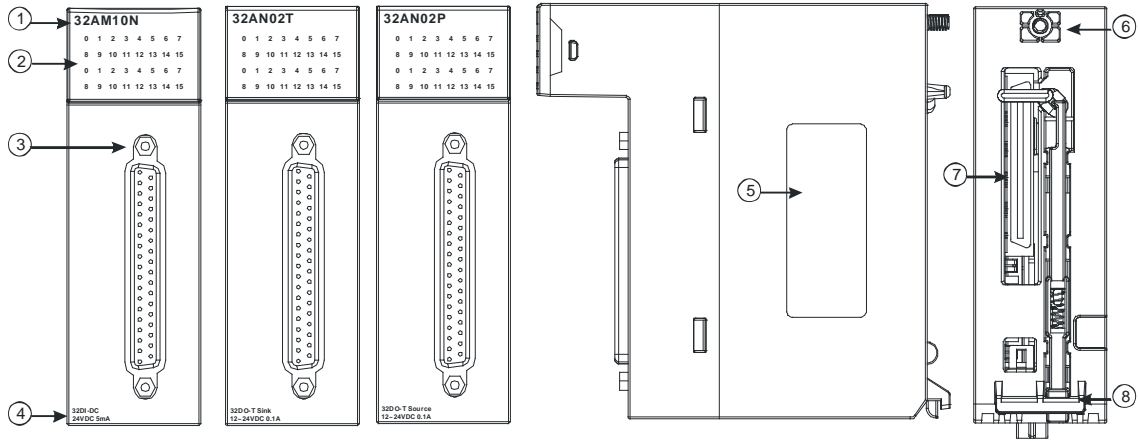

2

Number	Name	Description
1	Model name	Model name of the module
2	Input/Output LED indicator	If there is an input signal, the input LED indicator is ON. If there is an output signal, the output LED indicator is ON.
3	DB37 connector	It is connected to the I/O extension cable UC-ET010-33B.
4	Description of the inputs/outputs	Number of inputs/outputs and specifications
5	Label	Nameplate
6	Set screw	Fixing the module
7	Connector	Connecting the module and a backplane
8	Projection	Fixing the module

● AH32AM10N-5C/AH32AN02T-5C/AH32AN02P-5C

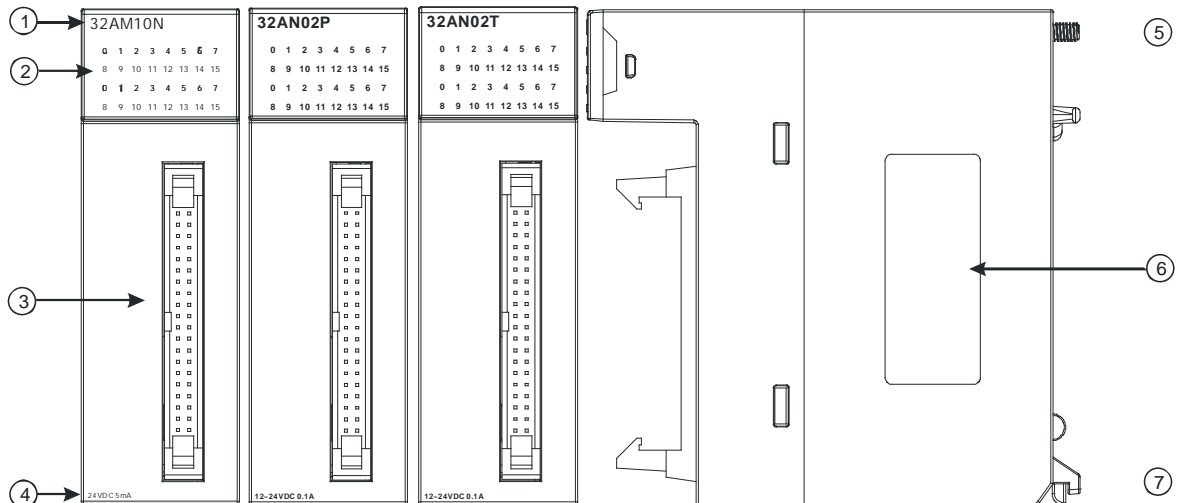

Number	Name	Description
1	Model name	Model name of the module
2	Input/Output LED indicator	If there is an input signal, the input LED indicator is ON. If there is an output signal, the output LED indicator is ON.
3	Latch connector	It is connected to the I/O extension cable UC-ET010-24A/UC-ET010-24C.
4	Description of the inputs/outputs	Number of inputs/outputs and specifications
5	Set screw	Fixing the module
6	Label	Nameplate
7	Projection	Fixing the module

2

● AH64AM10N-5C/AH64AN02T-5C/AH64AN02P-5C

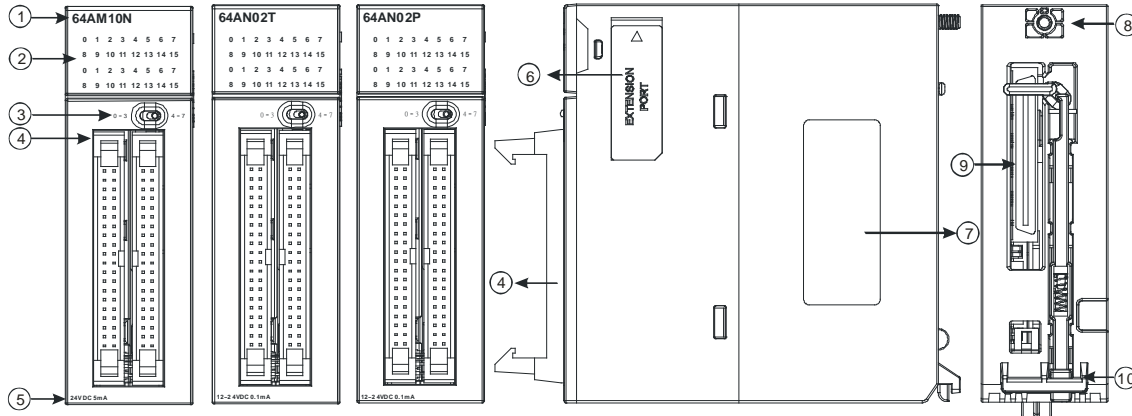

Number	Name	Description
1	Model name	Model name of the module
2	Input/Output LED indicator	If there is an input signal, the input LED indicator is ON. If there is an output signal, the output LED indicator is ON.
3	LED indicator switch	Left: High 32 bits Right: Low 32 bits
4	Latch connector	It is connected to the I/O extension cable UC-ET010-24A/UC-ET010-24C.
5	Description of the inputs/outputs	Number of inputs/outputs and specifications
6	Extension port	Updating the firmware
7	Label	Nameplate
8	Set screw	Fixing the module
9	Connector	It connects the module and a backplane.
10	Projection	Fixing the module

● DB37 connector, I/O extension cable, and external terminal module

1. I/O extension cable UC-ET010-33B

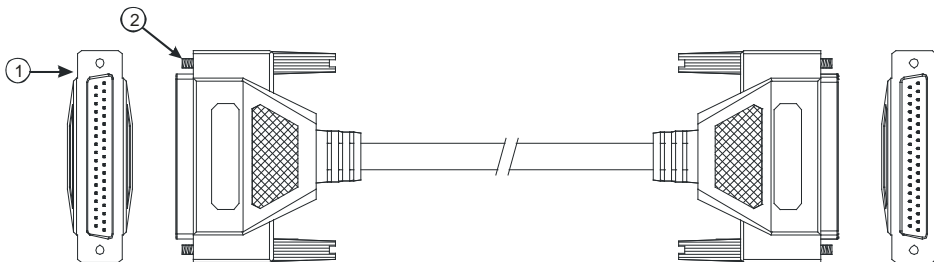

Number	Name	Description
1	DB37 connector	Connecting a digital input/output module and an external terminal module.
2	Set screw	Fixing the connector

2. External terminal module for AH32AM10N-5B: UB-10-ID32B

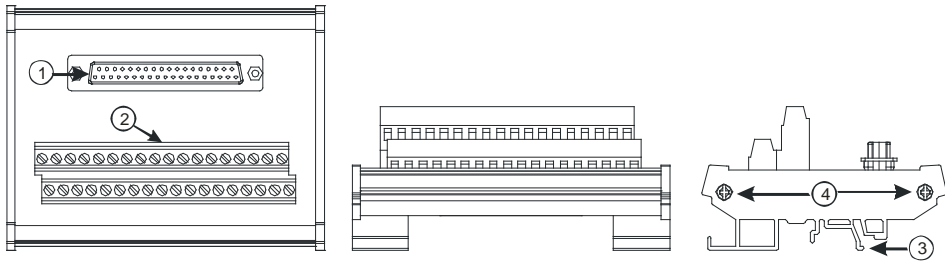

3. External terminal modules for AH32AN02T-5B

◆ UB-10-OR32A

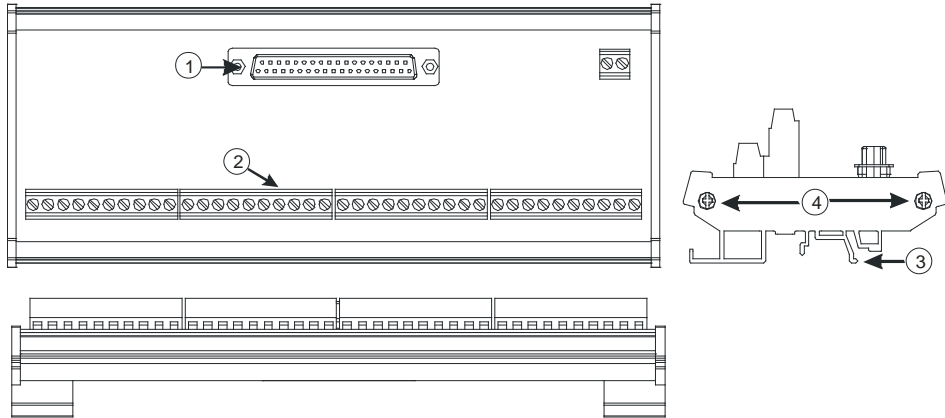

◆ UB-10-OT32B

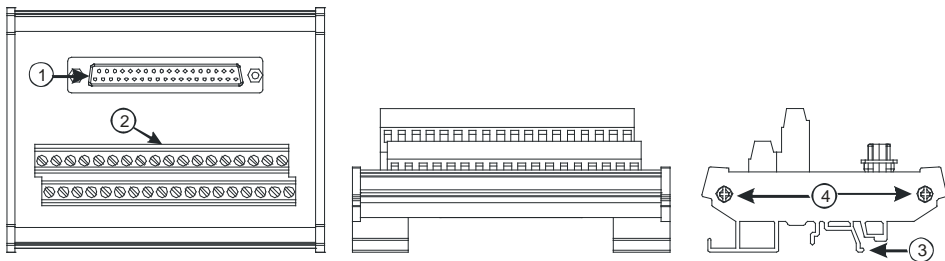

4. External terminal modules for AH32AN02P-5B

◆ UB-10-OR32B

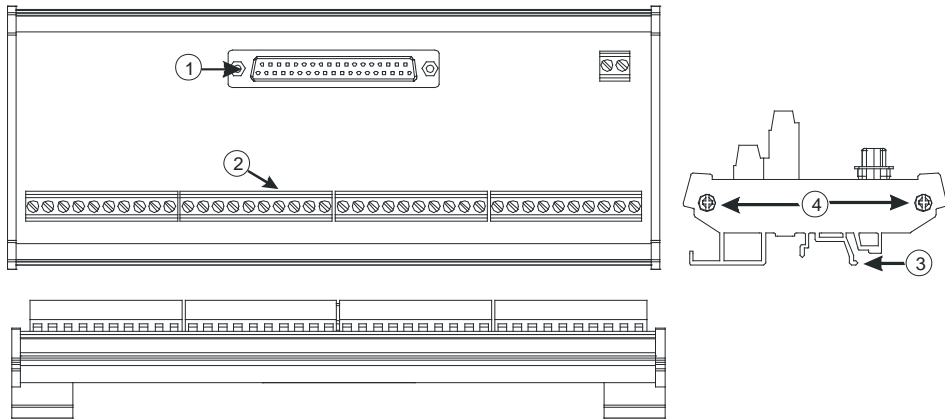

◆ UB-10-OT32B

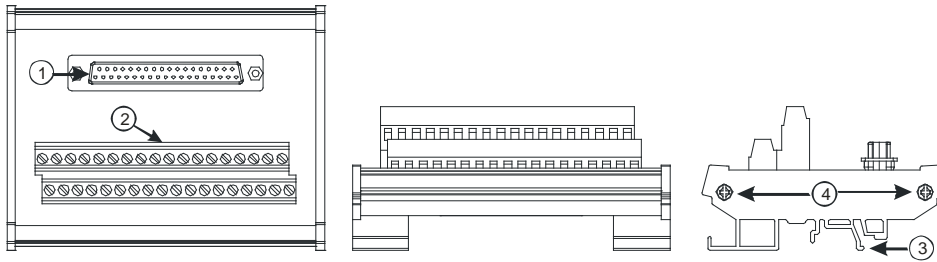

Number	Name	Description
1	DB37 connector	Connecting the external terminal module and a digital input/output module
2	Terminals	Input/Output terminals for wiring
3	Clip	Hanging the external terminal module on a DIN rail
4	Set screw	Fixing the base

● Latch connector, I/O extension cable, and external terminal module

1. I/O extension cable UC-ET010-24A

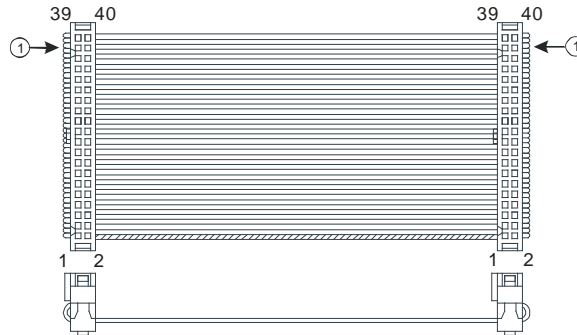

Number	Name	Description
1	40-pin IDC connector	Connecting a digital input/output module and the external terminal module UB-10-ID32A

2. External terminal module for AH32AM10N-5C/AH64AM10N-5C: UB-10-ID32A

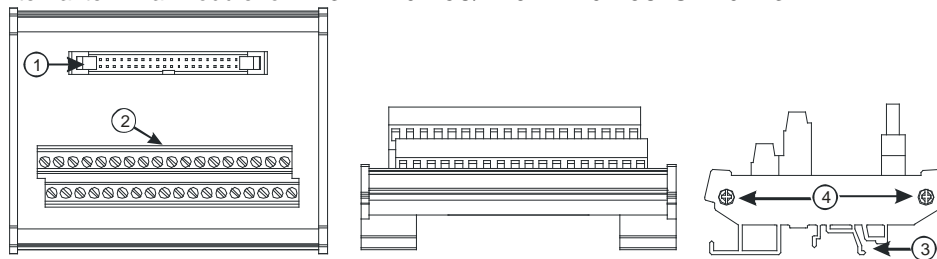

Number	Name	Description
1	40-pin latch connector	Connecting the external terminal module and a digital input/output module
2	Terminals	Input/Output terminals for wiring
3	Clip □	Hanging the external terminal module on a DIN rail
4	Set screw	Fixing the base

3. I/O extension cable UC-ET010-24C

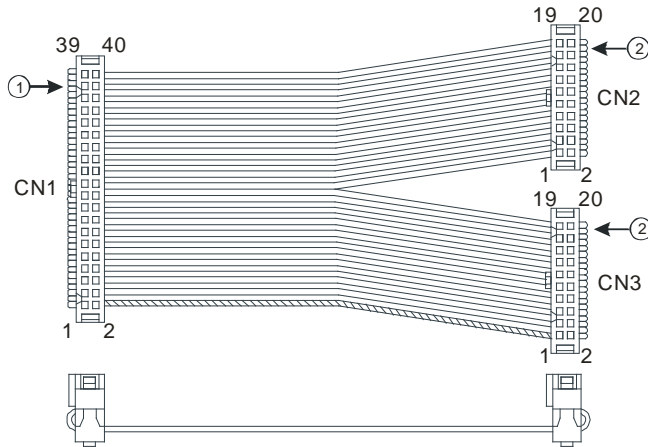

Number	Name	Description
1	40-pin IDC connector	Connecting a digital input/output module and an external terminal module.
2	20-pin IDC connector	Connecting a digital input/output module and the external terminal module UB-10-OR16A or UB-10-OR16B

4. I/O extension cable UC-ET010-24A

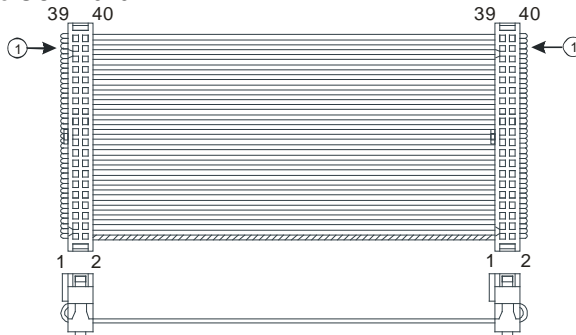

Number	Name	Description
1	40-pin IDC connector	Connecting a digital input/output module and the external terminal module UB-10-OT32A

5. External terminal modules for AH32AN02T-5C/AH64AN02T-5C

- ◆ UB-10-OR16A

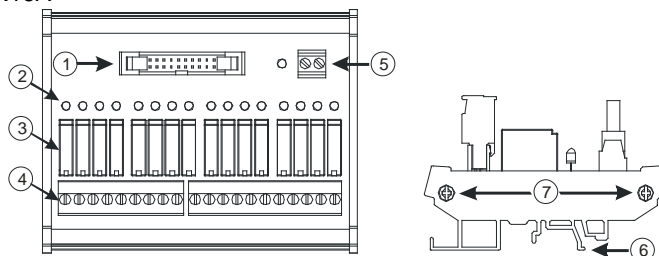

◆ UB-10-OT32A

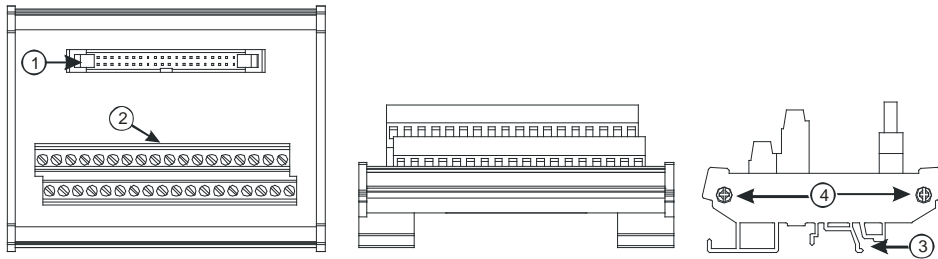

6. External terminal module for AH32AN02P-5C/AH64AN02P-5C

◆ UB-10-OR16B

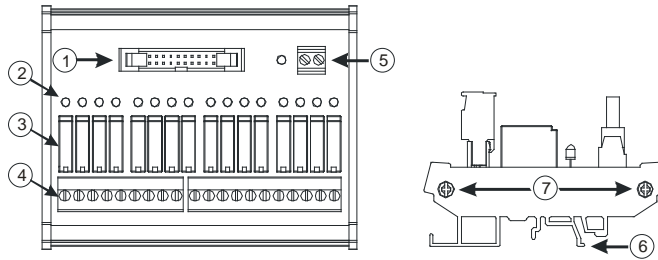

◆ UB-10-OT32A

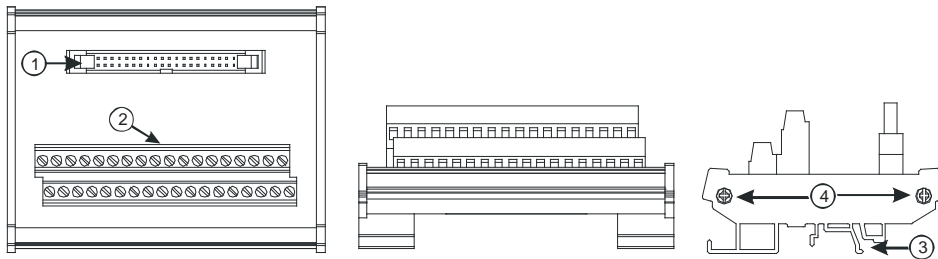

Number	Name	Description
1	20-pin latch connector	Connecting the external terminal module and a digital input/output module
2	Output LED indicator	If there is an output signal, the output LED indicator is ON.
3	Output relay	Output relay
4	Output terminal	Output terminal for wiring
5	Power input terminal	Power input terminal for wiring
6	Clip □	Hanging the external terminal module on a DIN rail
7	Set screw	Fixing the base

2.4.3 Dimensions

- AH16AM10N-5A/AH16AM30N-5A/AH16AR10N-5A/AH16AN01S-5A/AH16AN01R-5A/AH16AN01T-5A/AH16AN01P-5A/AH16AP11R-5A/AH16AP11T-5A/AH16AP11P-5A

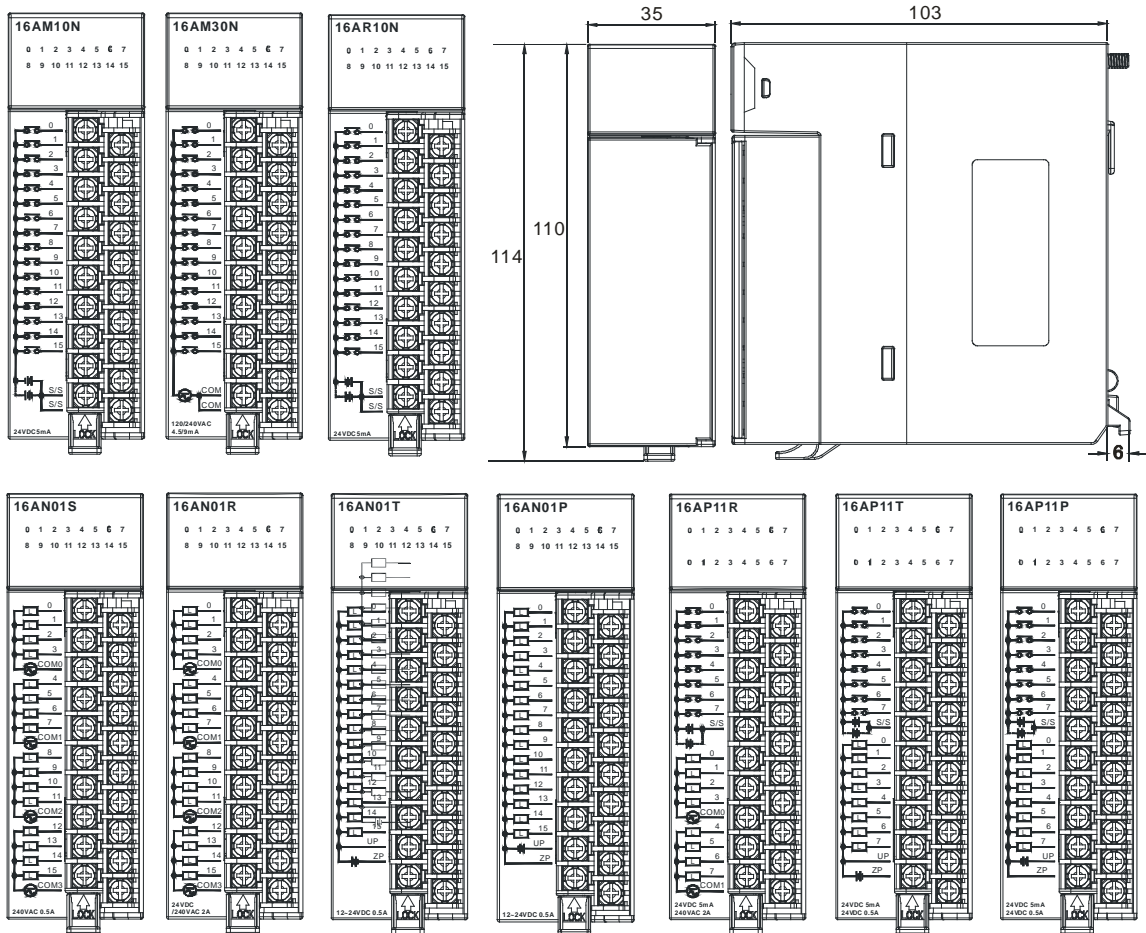

Unit: mm

- AH32AM10N-5A/AH32AN02T-5A/AH32AN02P-5A

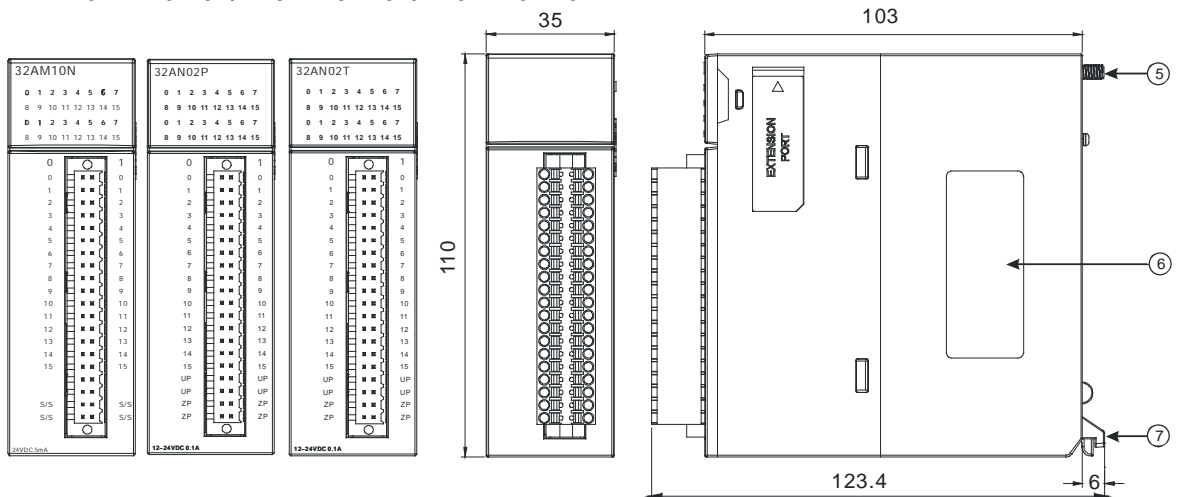

Unit: mm

2

● AH32AM10N-5B/AH32AN02T-5B/AH32AN02P-5B

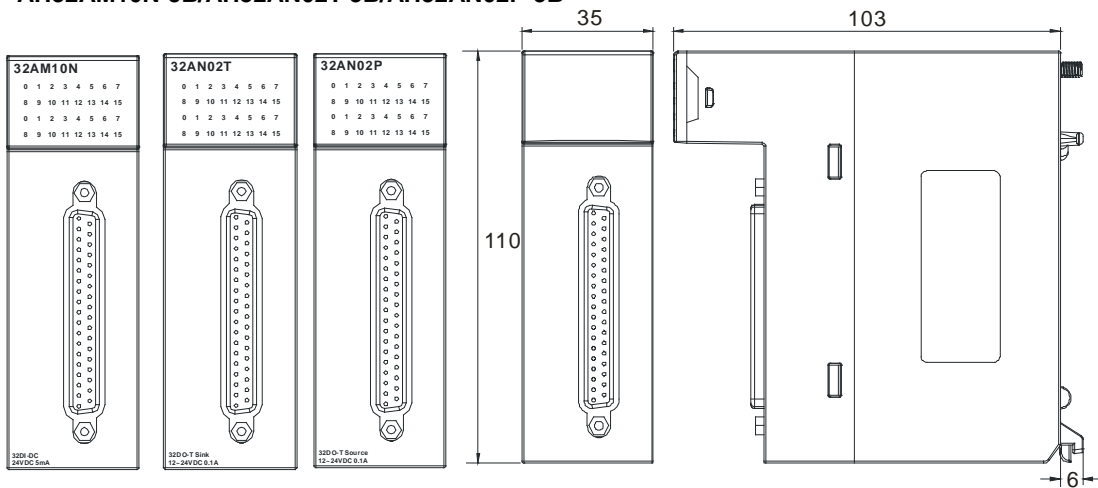

Unit: mm

● AH32AM10N-5C/AH32AN02T-5C/AH32AN02P-5C

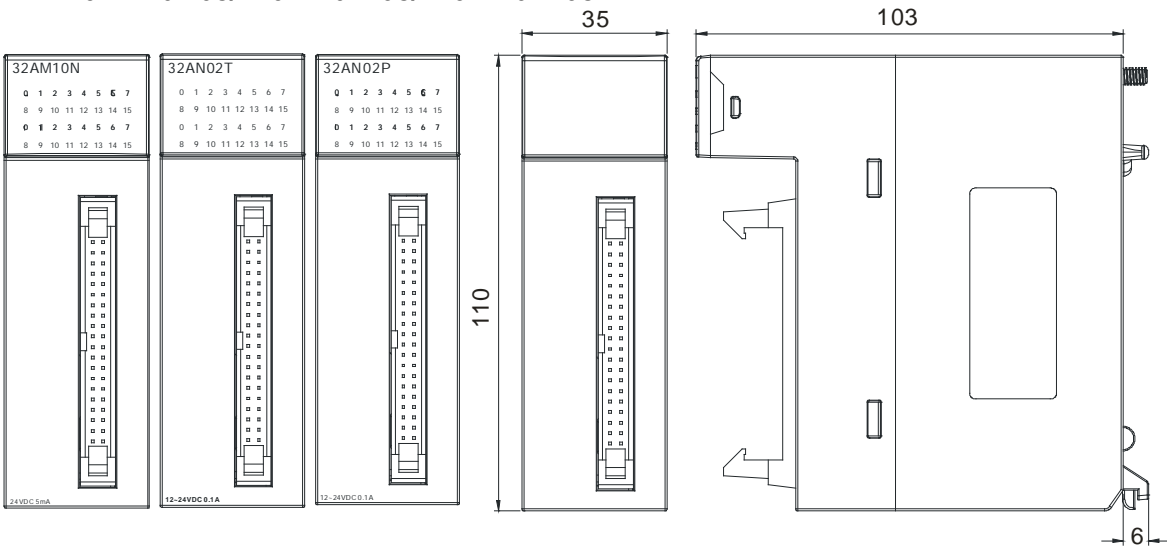

Unit: mm

● AH64AM10N-5C/AH64AN02T-5C/AH64AN02P-5C

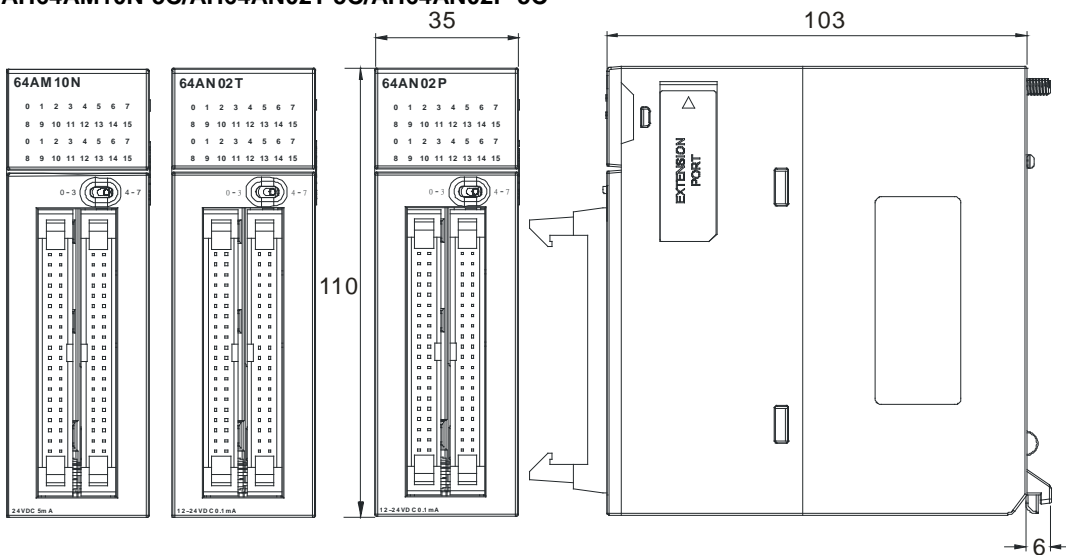

Unit: mm

● **DB37 connector, I/O extension cable, and external terminal module**

1. I/O extension cable UC-ET010-33B

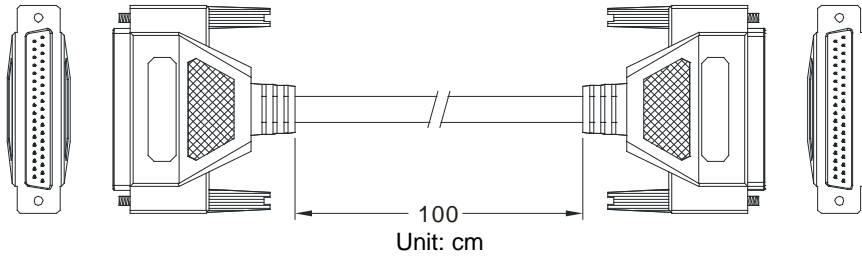

2. External terminal module for AH32AM10N-5B: UB-10-ID32B

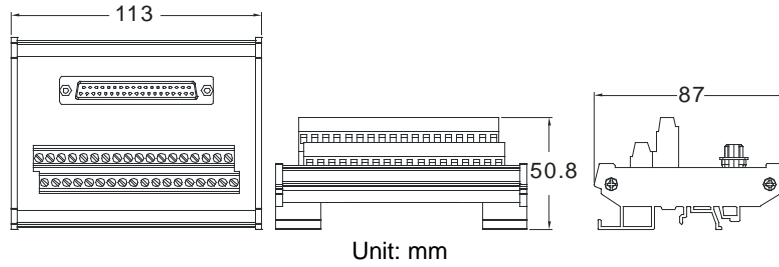

3. External terminal modules for AH32AN02T-5B

◆ UB-10-OR32A

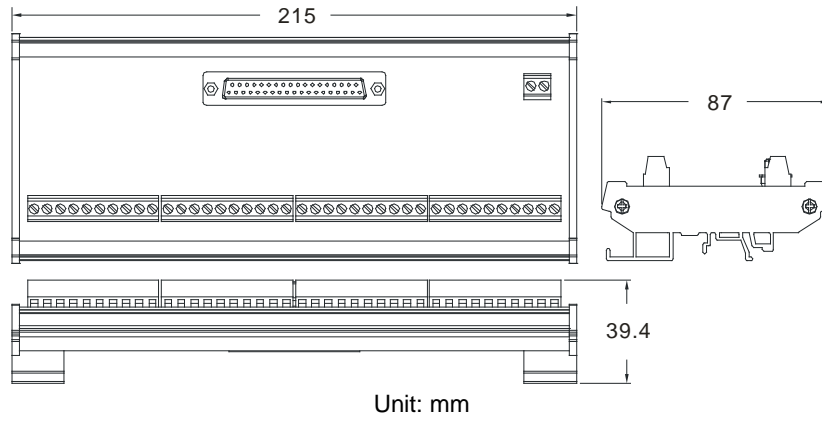

◆ UB-10-OT32B

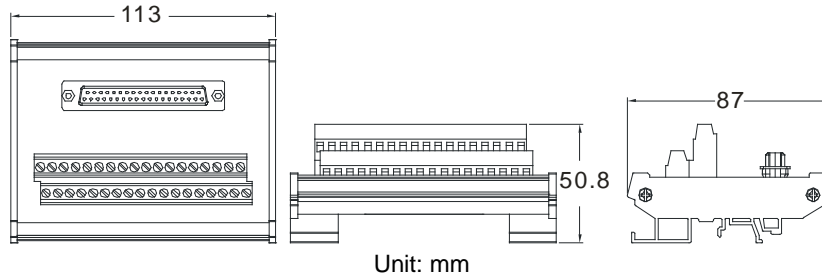

2

4. External terminal modules for AH32AN02P-5B

◆ UB-10-OR32B

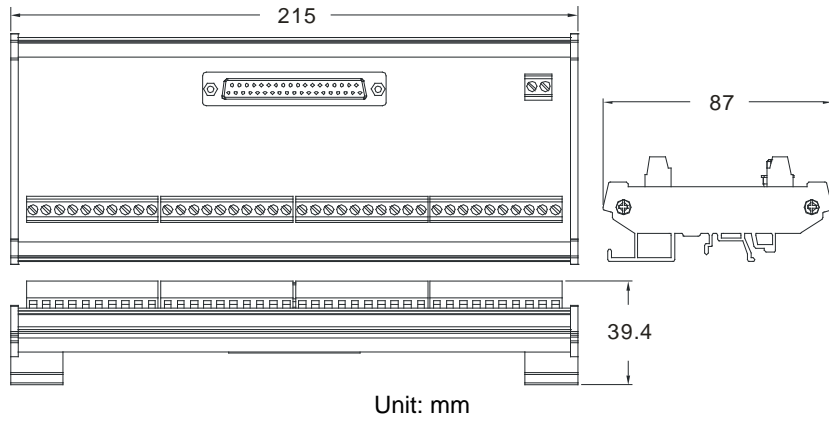

◆ UB-10-OT32B

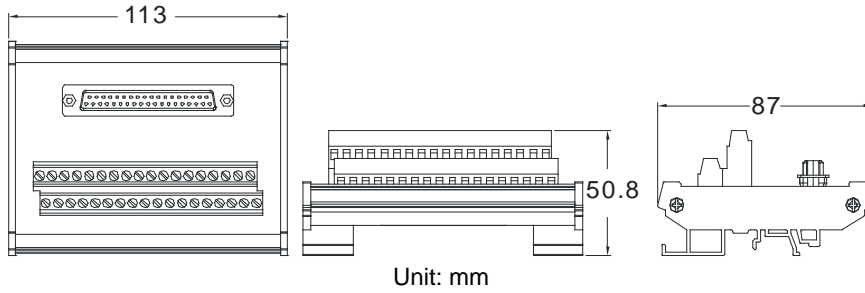

● Latch connector, I/O extension cable, and external terminal module

1. I/O extension cable UC-ET010-24A

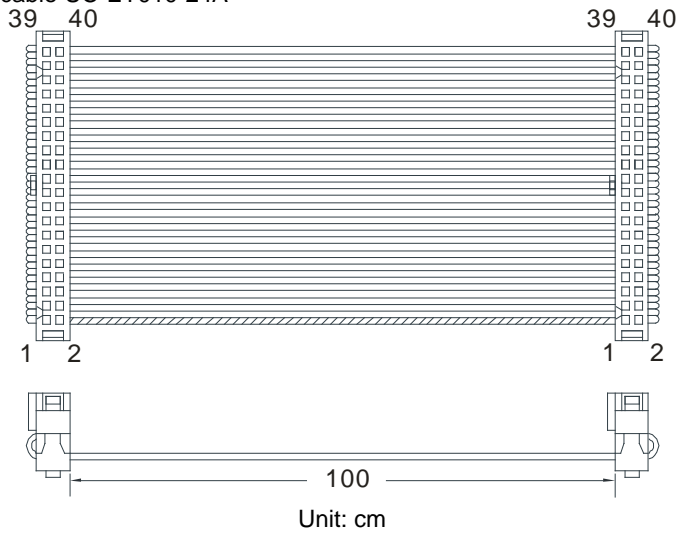

2. External terminal module for AH32AM10N-5C/AH64AM10N-5C: UB-10-ID32A

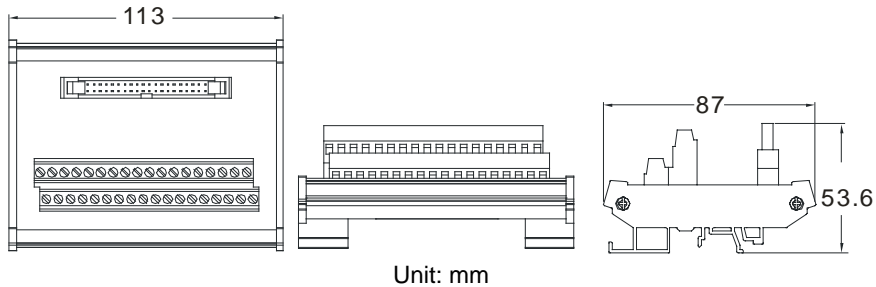

3. External terminal module for AH32AN02T-5C/AH64AN02T-5C: UB-10-OT32A

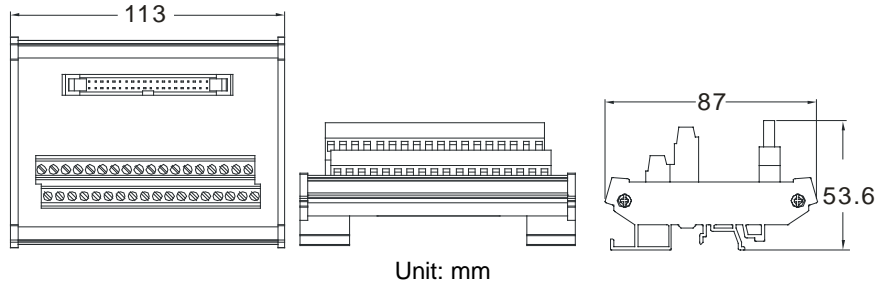

4. External terminal module for AH32AN02P-5C/AH64AN02P-5C: UB-10-OT32A

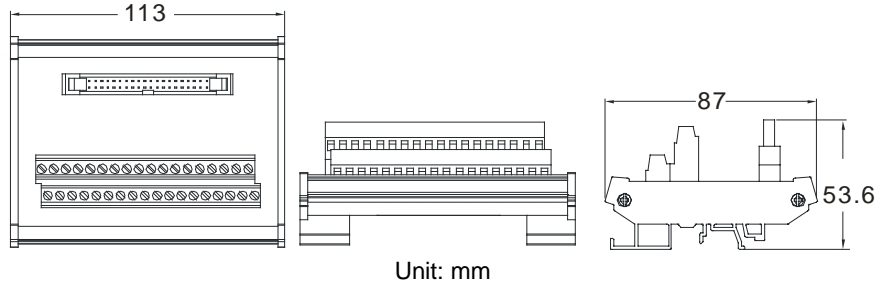

5. I/O extension cable UC-ET010-24C

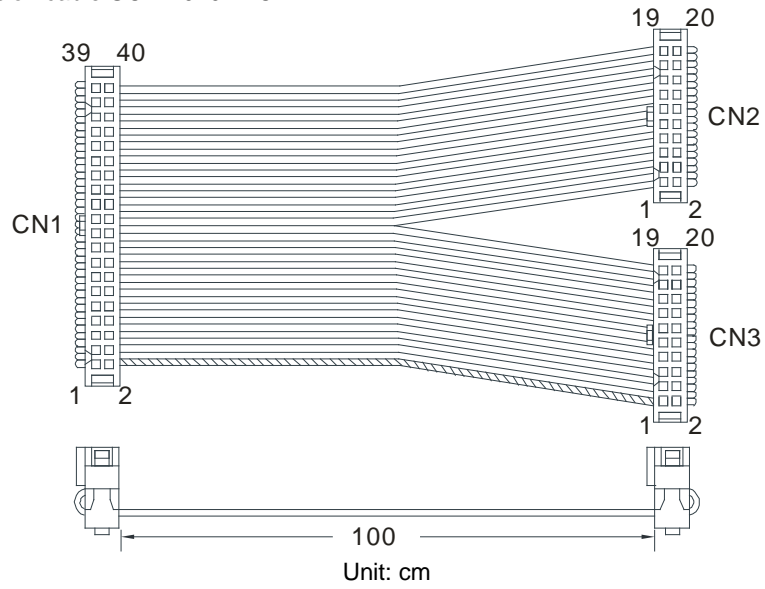

◆ External terminal module for AH32AN02T-5C/AH64AN02T-5C: UB-10-OR16A

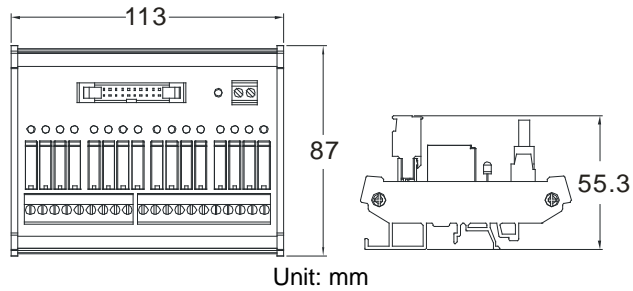

- ◆ External terminal module for AH32AN02P-5C/AH64AN02P-5C: UB-10-OR16B

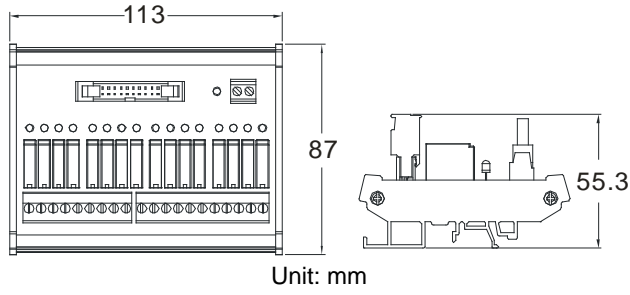

2

2.4.4 Arrangement of Input/Output Terminals

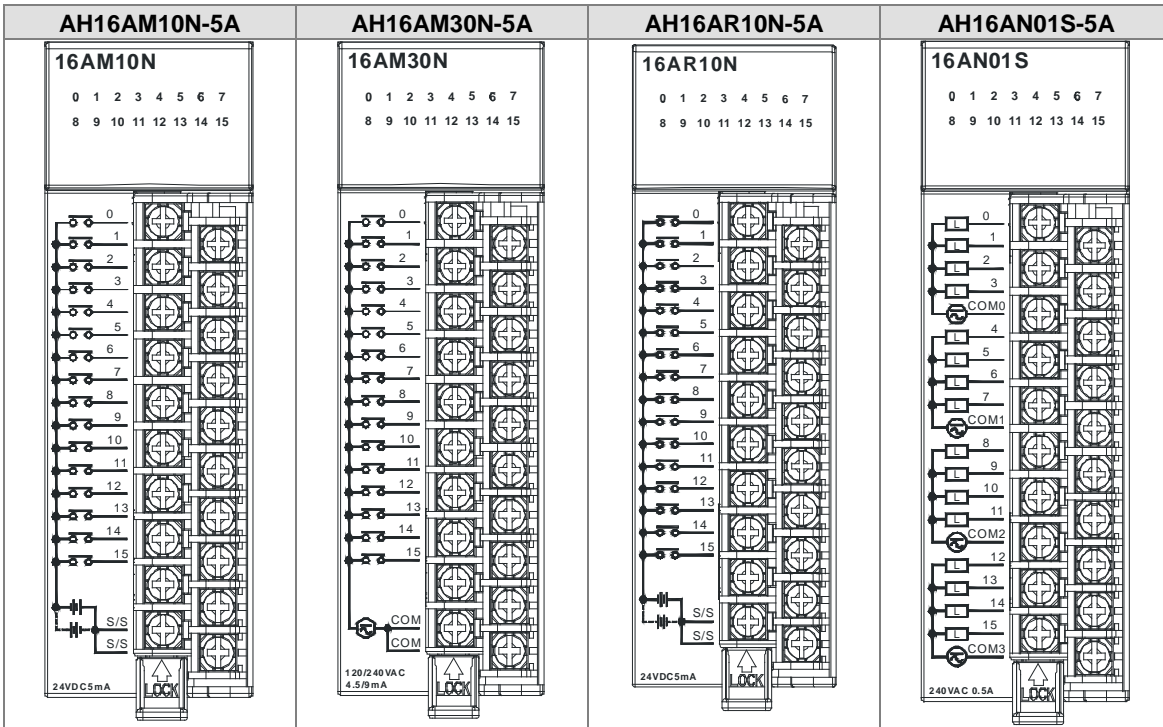

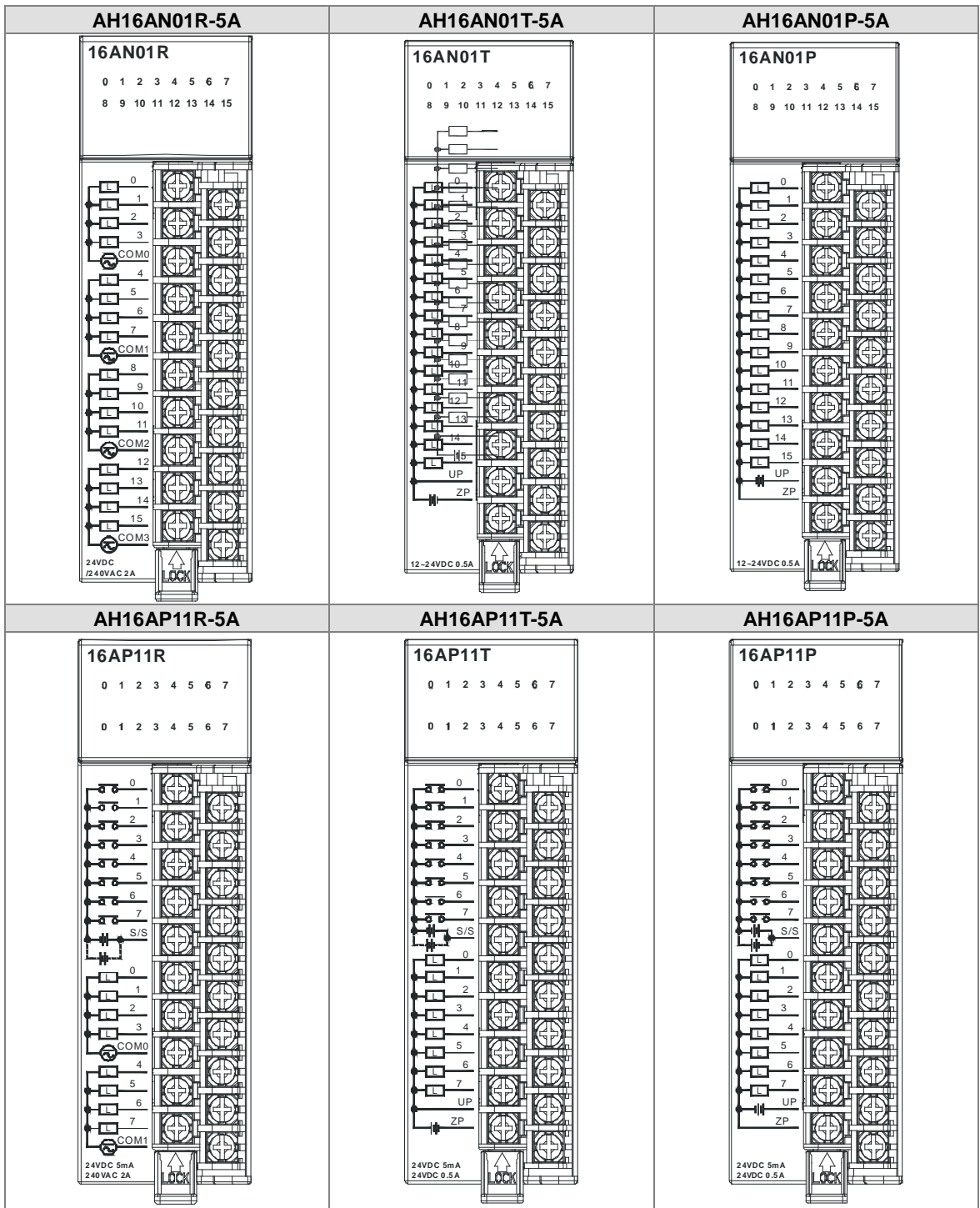

2

AH32AM10N-5A			AH32AN02T-5A		
<p>32AM10N</p> <p>0 1 2 3 4 5 6 7 8 9 10 11 12 13 14 15</p> <p>0 1 2 3 4 5 6 7 8 9 10 11 12 13 14 15</p> <p>0 1 2 3 4 5 6 7 8 9 10 11 12 13 14 15</p> <p>S/S S/S S/S S/S</p> <p>24VDC 5mA</p>	0.0	1.0	<p>32AN02T</p> <p>0 1 2 3 4 5 6 7 8 9 10 11 12 13 14 15</p> <p>0 1 2 3 4 5 6 7 8 9 10 11 12 13 14 15</p> <p>UP UP UP UP ZP ZP ZP ZP</p> <p>12-24VDC 0.1A</p>	0.0	1.0
	0.1	1.1		0.1	1.1
	0.2	1.2		0.2	1.2
	0.3	1.3		0.3	1.3
	0.4	1.4		0.4	1.4
	0.5	1.5		0.5	1.5
	0.6	1.6		0.6	1.6
	0.7	1.7		0.7	1.7
	0.8	1.8		0.8	1.8
	0.9	1.9		0.9	1.9
	0.10	1.10		0.10	1.10
	0.11	1.11		0.11	1.11
	0.12	1.12		0.12	1.12
	0.13	1.13		0.13	1.13
	0.14	1.14		0.14	1.14
	0.15	1.15		0.15	1.15
-	-	UP	UP		
-	-	UP	UP		
S/S	S/S	ZP	ZP		
S/S	S/S	ZP	ZP		

AH32AN02P-5A			AH32AM10N-5B		
<p>32AN02P</p> <p>0 1 2 3 4 5 6 7 8 9 10 11 12 13 14 15</p> <p>0 1 2 3 4 5 6 7 8 9 10 11 12 13 14 15</p> <p>UP UP UP UP ZP ZP ZP ZP</p> <p>12-24VDC 0.1A</p>	0.0	1.0	<p>32AM10N</p> <p>0 1 2 3 4 5 6 7 8 9 10 11 12 13 14 15</p> <p>0 1 2 3 4 5 6 7 8 9 10 11 12 13 14 15</p> <p>24VDC 5mA</p>	0.0	0.1
	0.1	1.1		0.2	0.3
	0.2	1.2		0.4	0.5
	0.3	1.3		0.6	0.7
	0.4	1.4		0.8	0.9
	0.5	1.5		0.10	0.11
	0.6	1.6		0.12	0.13
	0.7	1.7		0.14	0.15
	0.8	1.8		S/S	S/S
	0.9	1.9		NC	1.0
	0.10	1.10		1.1	1.2
	0.11	1.11		1.3	1.4
	0.12	1.12		1.5	1.6
	0.13	1.13		1.7	1.8
	0.14	1.14		1.9	1.10
	0.15	1.15		1.11	1.12
UP	UP	1.13	1.14		
UP	UP	1.15	S/S		
ZP	ZP	S/S			
ZP	ZP				

AH32AN02T-5B			AH32AN02P-5B		
	0.0	0.1		0.0	0.1
	0.2	0.3		0.2	0.3
	0.4	0.5		0.4	0.5
	0.6	0.7		0.6	0.7
	0.8	0.9		0.8	0.9
	0.10	0.11		0.10	0.11
	0.12	0.13		0.12	0.13
	0.14	0.15		0.14	0.15
	ZP	ZP		ZP	UP
	UP	1.0		UP	1.0
	1.1	1.2		1.1	1.2
	1.3	1.4		1.3	1.4
	1.5	1.6		1.5	1.6
	1.7	1.8		1.7	1.8
	1.9	1.10		1.9	1.10
	1.11	1.12		1.11	1.12
	1.13	1.14		1.13	1.14
	1.15	ZP		1.15	ZP
	UP			UP	

AH32AM10N-5C			AH32AN02T-5C		
	0.0	0.1		0.0	0.1
	0.2	0.3		0.2	0.3
	0.4	0.5		0.4	0.5
	0.6	0.7		0.6	0.7
	0.8	0.9		0.8	0.9
	0.10	0.11		0.10	0.11
	0.12	0.13		0.12	0.13
	0.14	0.15		0.14	0.15
	S/S	S/S		ZP	ZP
				UP	UP
	1.0	1.1		1.0	1.1
	1.2	1.3		1.2	1.3
	1.4	1.5		1.4	1.5
	1.6	1.7		1.6	1.7
	1.8	1.9		1.8	1.9
	1.10	1.11		1.10	1.11
	1.12	1.13		1.12	1.13
	1.14	1.15		1.14	1.15
	S/S	S/S		ZP	ZP
				UP	UP

2

AH32AN02P-5C			AH64AM10N-5C				
	0.0	0.1	64AM10N	NC	NC	NC	NC
	0.2	0.3		S/S	S/S	2.0	2.1
	0.4	0.5		1.15	1.14	2.2	2.3
	0.6	0.7		1.13	1.12	2.4	2.5
	0.8	0.9		1.11	1.10	2.6	2.7
	0.10	0.11		1.9	1.8	2.8	2.9
	0.12	0.13		1.7	1.6	2.10	2.11
	0.14	0.15		1.5	1.4	2.12	2.13
	ZP	ZP		1.3	1.2	2.14	2.15
	UP	UP		1.1	1.0	S/S	S/S
	1.0	1.1		NC	NC	NC	NC
	1.2	1.3		S/S	S/S	3.0	3.1
	1.4	1.5		0.15	0.14	3.2	3.3
	1.6	1.7		0.13	0.12	3.4	3.5
	1.8	1.9		0.11	0.10	3.6	3.7
	1.10	1.11		0.9	0.8	3.8	3.9
	1.12	1.13		0.7	0.6	3.10	3.11
	1.14	1.15		0.5	0.4	3.12	3.13
	ZP	ZP		0.3	0.2	3.14	3.15
	UP	UP		0.1	0.0	S/S	S/S

AH64AN02T-5C				AH64AN02P-5C					
	UP	UP	2.0	2.1		UP	UP	2.0	2.1
	ZP	ZP	2.2	2.3		ZP	ZP	2.2	2.3
	1.15	1.14	2.4	2.5		1.15	1.14	2.4	2.5
	1.13	1.12	2.6	2.7		1.13	1.12	2.6	2.7
	1.11	1.10	2.8	2.9		1.11	1.10	2.8	2.9
	1.9	1.8	2.10	2.11		1.9	1.8	2.10	2.11
	1.7	1.6	2.12	2.13		1.7	1.6	2.12	2.13
	1.5	1.4	2.14	2.15		1.5	1.4	2.14	2.15
	1.3	1.2	ZP	ZP		1.3	1.2	ZP	ZP
	1.1	1.0	UP	UP		1.1	1.0	UP	UP
	UP	UP	3.0	3.1		UP	UP	3.0	3.1
	ZP	ZP	3.2	3.3		ZP	ZP	3.2	3.3
	0.15	0.14	3.4	3.5		0.15	0.14	3.4	3.5
	0.13	0.12	3.6	3.7		0.13	0.12	3.6	3.7
	0.11	0.10	3.8	3.9		0.11	0.10	3.8	3.9
	0.9	0.8	3.10	3.11		0.9	0.8	3.10	3.11
	0.7	0.6	3.12	3.13		0.7	0.6	3.12	3.13
	0.5	0.4	3.14	3.15		0.5	0.4	3.14	3.15
	0.3	0.2	ZP	ZP		0.3	0.2	ZP	ZP
	0.1	0.0	UP	UP		0.1	0.0	UP	UP

● **DB37 connector and the external terminal module**

1. External terminal module for AH32AM10N-5B: UB-10-ID32B

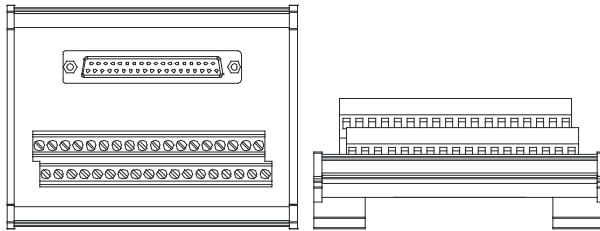

AH series terminals: (only applicable for AH series)

Upper row	X0.0	X0.2	X0.4	X0.6	X0.8	X0.10	X0.12	X0.14	X1.0	X1.2	X1.4	X1.6	X1.8	X1.10	X1.12	X1.14	S/S	S/S
Lower row	X0.1	X0.3	X0.5	X0.7	X0.9	X0.11	X0.13	X0.15	X1.1	X1.3	X1.5	X1.7	X1.9	X1.11	X1.13	X1.15	S/S	S/S

2. External terminal modules for AH32AN02T-5B

◆ UB-10-OT32B

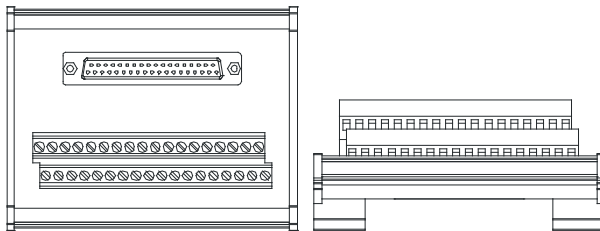

AH series terminals: (only applicable for AH series)

Upper row	Y0.0	Y0.2	Y0.4	Y0.6	Y0.8	Y0.10	Y0.12	Y0.14	Y1.0	Y1.2	Y1.4	Y1.6	Y1.8	Y1.10	Y1.12	Y1.14	UP	UP
Lower row	Y0.1	Y0.3	Y0.5	Y0.7	Y0.9	Y0.11	Y0.13	Y0.15	Y1.1	Y1.3	Y1.5	Y1.7	Y1.9	Y1.11	Y1.13	Y1.15	ZP	ZP

◆ UB-10-OR32A

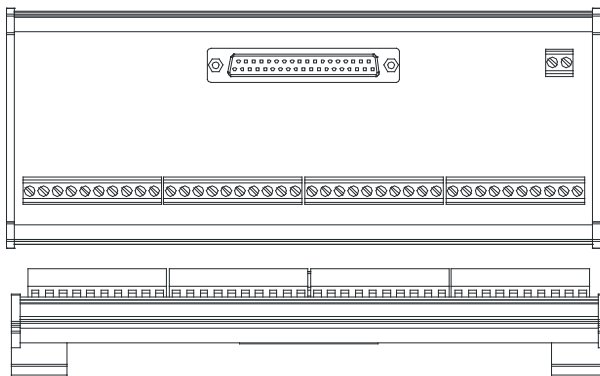

AH series terminals: (only applicable for AH series)

																				GND	+24V
1st from the left	C0	Y0.0	Y0.1	Y0.2	Y0.3	C1	Y0.4	Y0.5	Y0.6	Y0.7	C2	Y0.8	Y0.9	Y0.10	Y0.11	C3	Y0.12	Y0.13	Y0.14	Y0.15	
21st from the left	C4	Y1.0	Y1.1	Y1.2	Y1.3	C5	Y1.4	Y1.5	Y1.6	Y1.7	C6	Y1.8	Y1.9	Y1.10	Y1.11	C7	Y1.12	Y1.13	Y1.14	Y1.15	

3. External terminal modules for AH32AN02P-5B

◆ UB-10-OT32B

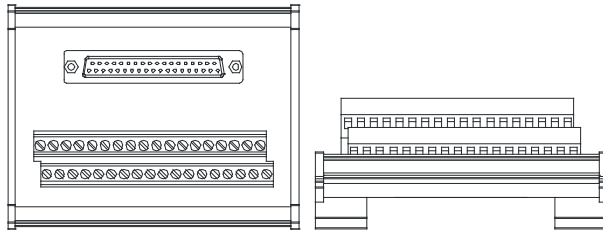

AH series terminals: (only applicable for AH series)

Upper row	Y0.0	Y0.2	Y0.4	Y0.6	Y0.8	Y0.10	Y0.12	Y0.14	Y1.0	Y1.2	Y1.4	Y1.6	Y1.8	Y1.10	Y1.12	Y1.14	UP	UP
Lower row	Y0.1	Y0.3	Y0.5	Y0.7	Y0.9	Y0.11	Y0.13	Y0.15	Y1.1	Y1.3	Y1.5	Y1.7	Y1.9	Y1.11	Y1.13	Y1.15	ZP	ZP

◆ UB-10-OR32B

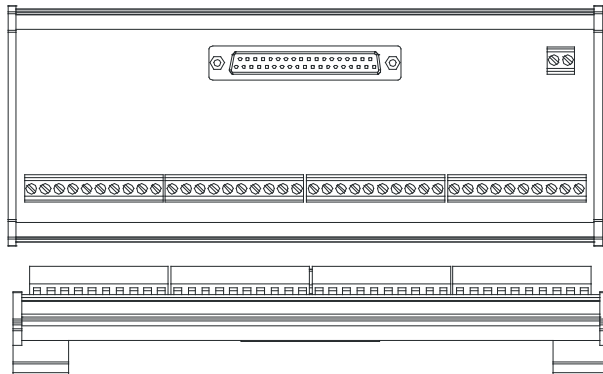

AH series terminals: (only applicable for AH series)

																				GND	+24V
1 st from the left	C0	Y0.0	Y0.1	Y0.2	Y0.3	C1	Y0.4	Y0.5	Y0.6	Y0.7	C2	Y0.8	Y0.9	Y0.10	Y0.11	C3	Y0.12	Y0.13	Y0.14	Y0.15	
21 st from the left	C4	Y1.0	Y1.1	Y1.2	Y1.3	C5	Y1.4	Y1.5	Y1.6	Y1.7	C6	Y1.8	Y1.9	Y1.10	Y1.11	C7	Y1.12	Y1.13	Y1.14	Y1.15	

● Latch connector and external terminal module

1. External terminal module for AH32AM10N-5C/AH64AM10N-5C: UB-10-ID32A

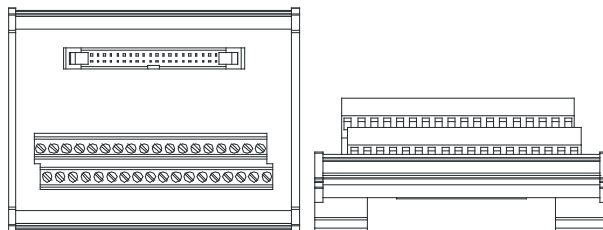

AH series terminals: (only applicable for AH series)

Upper row	X0.0	X0.2	X0.4	X0.6	X0.8	X0.10	X0.12	X0.14	X1.0	X1.2	X1.4	X1.6	X1.8	X1.10	X1.12	X1.14	S/S	S/S
Lower row	X0.1	X0.3	X0.5	X0.7	X0.9	X0.11	X0.13	X0.15	X1.1	X1.3	X1.5	X1.7	X1.9	X1.11	X1.13	X1.15	S/S	S/S

2. External terminal modules for AH32AN02T-5C/AH64AN02T-5C:

◆ UB-10-OT32A

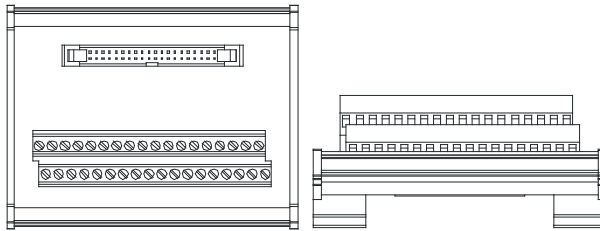

AH series terminals: (only applicable for AH series)

Upper row	Y0.0	Y0.2	Y0.4	Y0.6	Y0.8	Y0.10	Y0.12	Y0.14	Y1.0	Y1.2	Y1.4	Y1.6	Y1.8	Y1.10	Y1.12	Y1.14	+24V	+24V
Lower row	Y0.1	Y0.3	Y0.5	Y0.7	Y0.9	Y0.11	Y0.13	Y0.15	Y1.1	Y1.3	Y1.5	Y1.7	Y1.9	Y1.11	Y1.13	Y1.15	GND	GND

◆ UB-10-OR16A

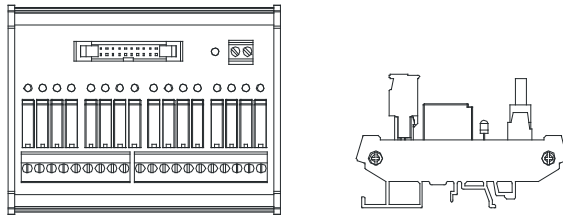

AH series terminals: (only applicable for AH series)

																			GND	+24V
C0	Y0.0	Y0.1	Y0.2	Y0.3	C1	Y0.4	Y0.5	Y0.6	Y0.7	C2	Y0.8	Y0.9	Y0.10	Y0.11	C3	Y0.12	Y0.13	Y0.14	Y0.15	

3. External terminal module for AH32AN02P-5C/AH64AN02P-5C:

◆ UB-10-OT32A

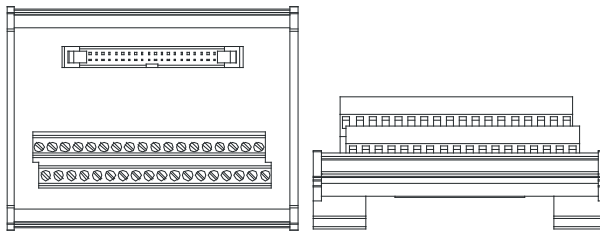

AH series terminals: (only applicable for AH series)

Upper row	Y0.0	Y0.2	Y0.4	Y0.6	Y0.8	Y0.10	Y0.12	Y0.14	Y1.0	Y1.2	Y1.4	Y1.6	Y1.8	Y1.10	Y1.12	Y1.14	+24V	+24V
Lower row	Y0.1	Y0.3	Y0.5	Y0.7	Y0.9	Y0.11	Y0.13	Y0.15	Y1.1	Y1.3	Y1.5	Y1.7	Y1.9	Y1.11	Y1.13	Y1.15	GND	GND

◆ UB-10-OR16B

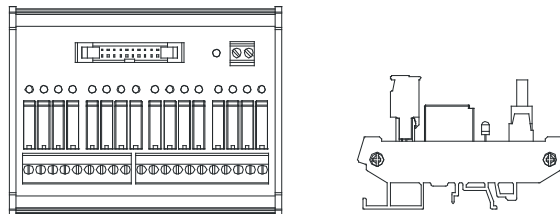

AH series terminals: (only applicable for AH series)

																			GND	+24V
C0	Y0.0	Y0.1	Y0.2	Y0.3	C1	Y0.4	Y0.5	Y0.6	Y0.7	C2	Y0.8	Y0.9	Y0.10	Y0.11	C3	Y0.12	Y0.13	Y0.14	Y0.15	

2.5 Specifications for Analog Input/Output Modules

2.5.1 General Specifications

- AH04AD-5A/ AH08AD-5A/AH08AD-5B/AH08AD-5C

Electrical specifications

Module name	AH04AD-5A	AH08AD-5B	AH08AD-5B	AH08AD-5C
Number of inputs	4	8	8	8
Analog-to-digital conversion	Voltage input/Current input	Voltage input/Current input	Voltage input	Current input
Supply voltage	24 V DC (20.4 V DC~28.8 V DC) (-15%~+20%)			
Connector type	Removable terminal block			
Conversion time	150 μ s/channel			
Isolation	An analog circuit is isolated from a digital circuit by a digital integrated circuit/an optocoupler, but the analog channels are not isolated from one another. Isolation between a digital circuit and a ground: 500 V DC Isolation between an analog circuit and a ground: 500 V DC Isolation between an analog circuit and a digital circuit: 500 V DC Isolation between the 24 V DC and a ground: 500 V DC			
Weight	200g			

Functional specifications

Analog-to-digital conversion	Voltage input				
Rated input range	-10 V~10 V	0 V~10 V	± 5 V	0 V~5 V	1 V~5 V
Hardware input range	-10.1 V~10.1 V	-0.1 V~10.1 V	-5.05 V~5.05 V	-0.05 V~5.05 V	0.95 V~5.05 V
Fiducial error (Room temperature) (The number of input voltages which are averaged is 100.)	$\pm 0.1\%$				
Fiducial error (Full temperature range) (The number of input voltages which are averaged is 100.)	$\pm 0.45\%$				
Linearity error (Room temperature)	$\pm 0.07\%$				
Linearity error (Full temperature range)	$\pm 0.12\%$				
Hardware resolution	16 bits				
Input impedance	>200 k Ω				
Absolute input range	± 15 V				

Analog-to-digital conversion	Current input		
Rated input range	± 20 mA	0 mA~20 mA	4 mA~20 mA
Hardware input	-20.2 mA~20.2 mA	-0.2 mA~20.2 mA	3.8 mA~20.2 mA

Analog-to-digital conversion	Current input		
range			
Fiducial error (Room temperature) (The number of input currents which are averaged is 100.)	±0.1%		
Fiducial error (Full temperature range) (The number of input currents which are averaged is 100.)	±0.2%		
Linearity error (Room temperature) (Full temperature range)	±0.05%		
Linearity error	±0.23%		
Hardware resolution	16 bits		
Input impedance	250 Ω		
Absolute input range	±32 mA		

- AH04DA-5A/ AH08DA-5A /AH08DA-5B/AH08DA-5C

Electrical specifications

Module name	AH04DA-5A	AH08DA-5A	AH08DA-5B	AH08DA-5C
Number of outputs	4	8	8	8
Analog-to-digital conversion	Voltage output/Current output	Voltage output/Current output	Voltage output	Current output
Supply voltage	24 V DC (20.4 V DC~28.8 V DC) (-15%~+20%)			
Connector type	Removable terminal block			
Conversion time	150 μs/channel			
Isolation	An analog circuit is isolated from a digital circuit by a digital integrated circuit/an optocoupler, but the analog channels are not isolated from one another. Isolation between a digital circuit and a ground: 500 V DC Isolation between an analog circuit and a ground: 500 V DC Isolation between an analog circuit and a digital circuit: 500 V DC Isolation between the 24 V DC and a ground: 500 V DC			
Weight	210g			

Functional specifications

Analog-to-digital conversion	Voltage output				
Rated output range	±10 V	0 V~10 V	±5 V	0 V~5 V	1 V~5 V
Hardware output range	-10.1 V~10.1 V	-0.1 V~10.1 V	-5.05 V~5.05 V	-0.05 V~5.05 V	0.95 V~5.05 V
Fiducial error (Room	±0.02%				

2

Analog-to-digital conversion	Voltage output	
temperature) (The number of output voltages which are averaged is 100.)		
Fiducial error (Full temperature range) (The number of output voltages which are averaged is 100.)	±0.04%	
Linearity error (Room temperature)	±0.004%	
Linearity error (Full temperature range)	±0.004%	
Hardware resolution	16 bits	
Permissible load impedance	1 kΩ~2 MΩ: ±10 V and 0 V~10 V ≥500 Ω: 1 V~5 V	

Analog-to-digital conversion	Current output	
Rated output range	0 mA~20 mA	4 mA~20 mA
Hardware output range	-0.2 mA~20.2 mA	3.8 mA~20.2 mA
Fiducial error (Room temperature) (The number of output currents which are averaged is 100.)	±0.06%	
Fiducial error (Full temperature range) (The number of output currents which are averaged is 100.)	±0.07%	
Linearity error (Room temperature)	±0.01%	
Linearity error (Full temperature range)	±0.01%	
Hardware resolution	16 bits	
Permissible load impedance	≤550 Ω	

● AH06XA-5A

Electrical specifications

Module name	AH06XA-5A
Number of analog inputs	4 inputs
Number of analog outputs	2 outputs
Analog-to-digital conversion	Voltage input/Current input/Voltage output/Current output
Supply voltage	24 V DC (20.4 V DC~28.8 V DC) (-15%~+20%)
Connector type	Removable terminal block
Conversion time	150 us/channel
Isolation	An analog circuit is isolated from a digital circuit by a digital integrated circuit/an optocoupler, but the analog channels are not isolated from one another. Isolation between a digital circuit and a ground: 500 V DC Isolation between an analog circuit and a ground: 500 V DC Isolation between an analog circuit and a digital circuit: 500 V DC Isolation between the 24 V DC and a ground: 500 V DC
Weight	210g

Functional specifications for the analog-to-digital conversion

Analog-to-digital conversion	Voltage input				
	Rated input range	-10 V~10 V	0 V~10 V	±5 V	0 V~5 V
Hardware input range	-10.1 V~10.1 V	-0.1 V~10.1 V	-5.05 V~5.05 V	-0.05 V~5.05 V	0.95 V~5.05 V
Fiducial error (Room temperature) (The number of input voltages which are averaged is 100.)	±0.1%				
Fiducial error (Full temperature range) (The number of input voltages which are averaged is 100.)	±0.45%				
Linearity error (Room temperature)	±0.07%				
Linearity error (Full temperature range)	±0.12%				
Hardware resolution	16 bits				
Input impedance	>200 kΩ				
Absolute input range	±15 V				

Analog-to-digital conversion	Current input		
	Rated input range	±20 mA	0 mA~20 mA
Hardware input range	-20.2 mA~20.2 mA	-0.2 mA~20.2 mA	3.8 mA~20.2 mA

2

Analog-to-digital conversion	Current input
Fiducial error (Room temperature) (The number of input currents which are averaged is 100.)	$\pm 0.1\%$
Fiducial error (Full temperature range) (The number of input currents which are averaged is 100.)	$\pm 0.2\%$
Linearity error (Room temperature)	$\pm 0.05\%$
Linearity error (Full temperature range)	$\pm 0.23\%$
Hardware resolution	16 bits
Input impedance	250 Ω
Absolute input range	± 32 mA

Functional specifications for the digital-to-analog conversion

Digital-to-analog conversion	Voltage output				
Rated output range	± 10 V	0 V~10 V	± 5 V	0 V~5 V	1 V~5 V
Hardware output range	-10.1 V~10.1 V	-0.1 V~10.1 V	-5.05 V~5.05 V	-0.05 V~5.05 V	0.95 V~5.05 V
Fiducial error (Room temperature) (The number of output voltages which are averaged is 100.)	$\pm 0.02\%$				
Fiducial error (Full temperature range) (The number of output voltages which are averaged is 100.)	$\pm 0.04\%$				
Linearity error (Room temperature)	$\pm 0.004\%$				
Linearity error (Full temperature range)	$\pm 0.004\%$				
Hardware resolution	16 bits				
Permissible load impedance	1 k Ω ~2 M Ω : ± 10 V and 0 V~10 V ≥ 500 Ω : 1 V~5 V				

Digital-to-analog conversion	Current output	
Rated output range	0 mA~20 mA	4 mA~20 mA
Hardware output range	-0.2 mA~20.2 mA	3.8 mA~20.2 mA
Fiducial error (Room temperature) (The number of output currents which are averaged is 100.)	±0.06%	
Fiducial error (Full temperature range) (The number of output currents which are averaged is 100.)	±0.07%	
Linearity error (Room temperature)	±0.01%	
Linearity error (Full temperature range)	±0.01%	
Hardware resolution	16 bits	
Permissible load impedance	≤550 Ω	

2.5.2 Profiles

- AH04AD-5A/AH08AD-5B/AH08AD-5C/AH04DA-5A/AH08DA-5B/AH08DA-5C/AH06XA-5A

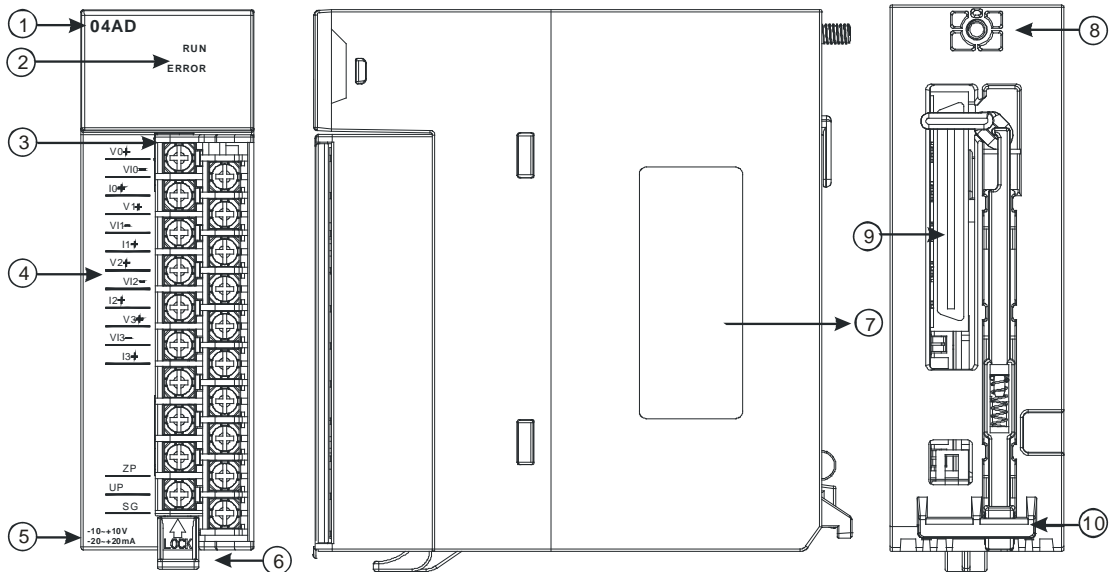

- AH08AD-5A/AH08DA-5A

2

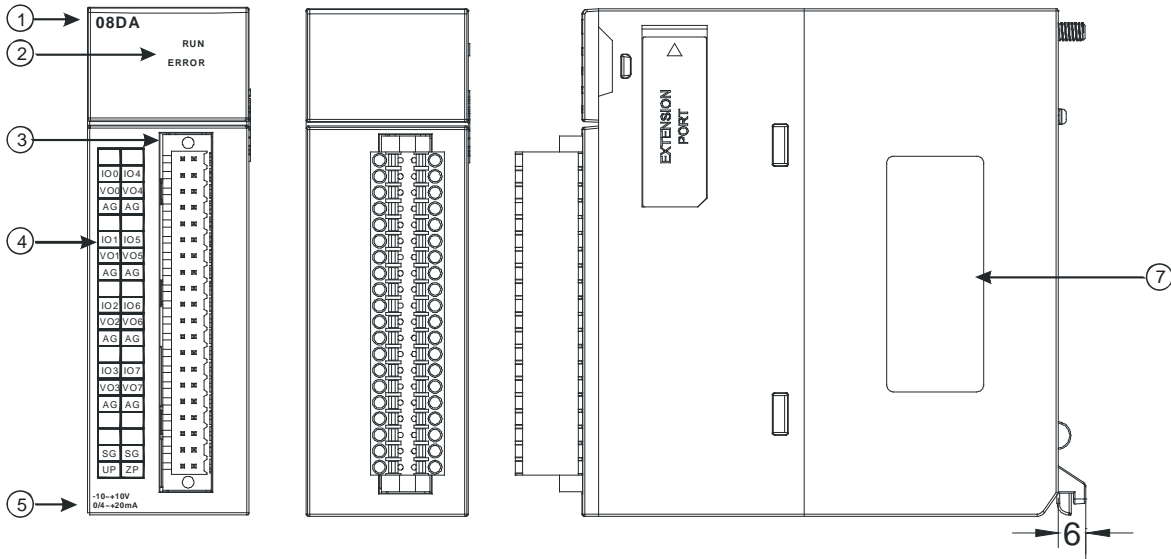

Number	Name	Description
1	Model name	Model name of the module
2	RUN LED indicator	Operating status of the module ON: The module is running. OFF: The module stops running.
	ERROR LED indicator	Error status of the module ON: A serious error occurs in the module. OFF: The module is normal. Blinking: A slight error occurs in the module.
3	Removable terminal block	The inputs are connected to a sensor. The outputs are connected to a load which will be driven.
4	Arrangement of the input/output terminals	Arrangement of the terminals
5	Description of the inputs/outputs	Simple specifications for the module
6	Clip	Removing the terminal block
7	Label	Nameplate
8	Set screw	Fixing the module
9	Connector	Connecting the module and a backplane
10	Projection	Fixing the module

2.5.3 Dimensions

- AH04AD-5A/AH08AD-5B/AH08AD-5C/AH04DA-5A/AH08DA-5B/AH08DA-5C/AH06XA-5A

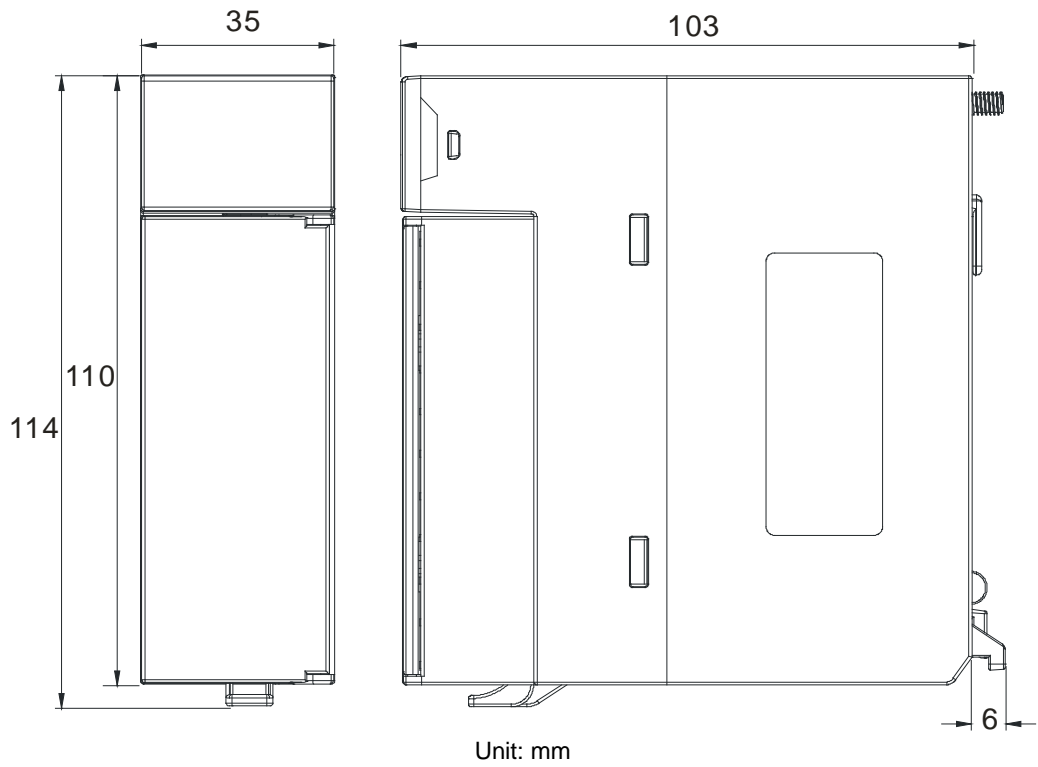

2

- AH08AD-5A/AH08DA-5A

2

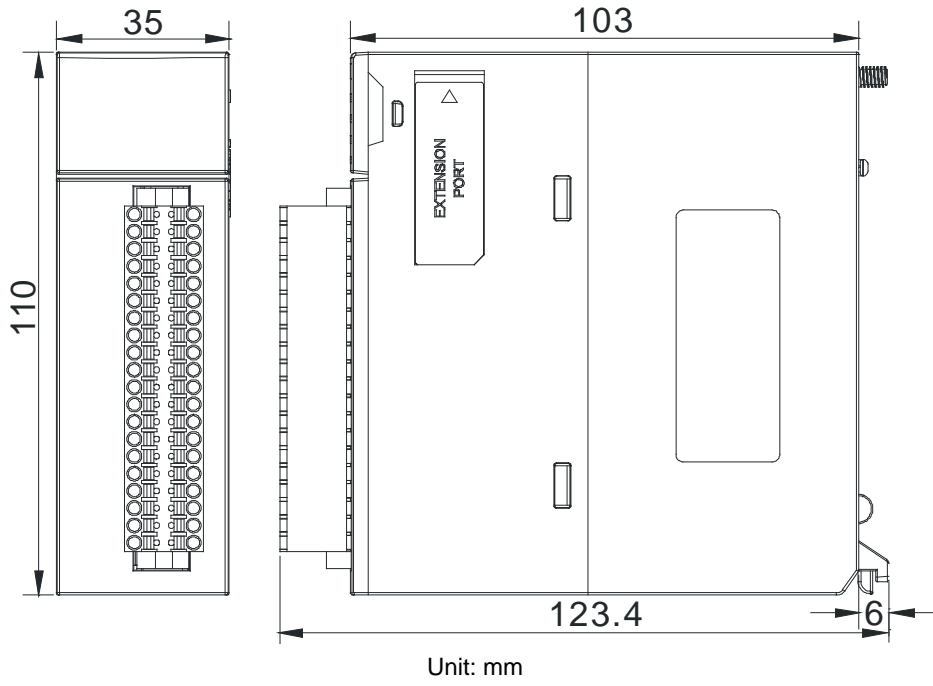

2.5.4 Arrangement of Input/Output Terminals

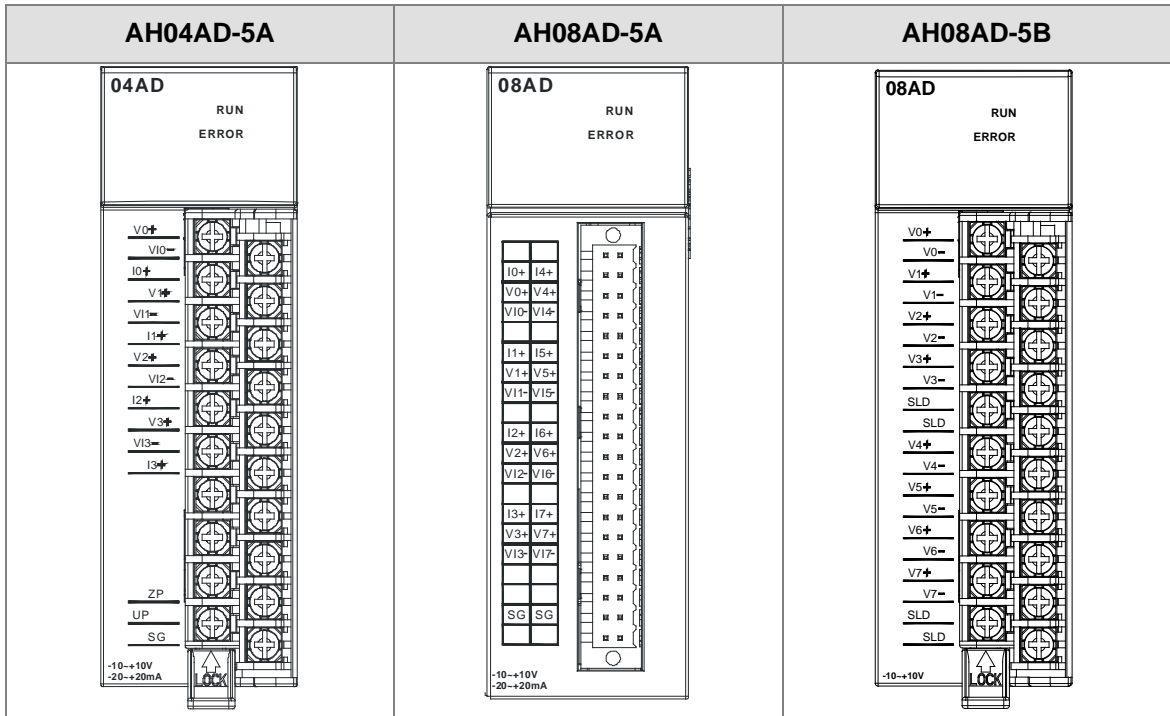

2

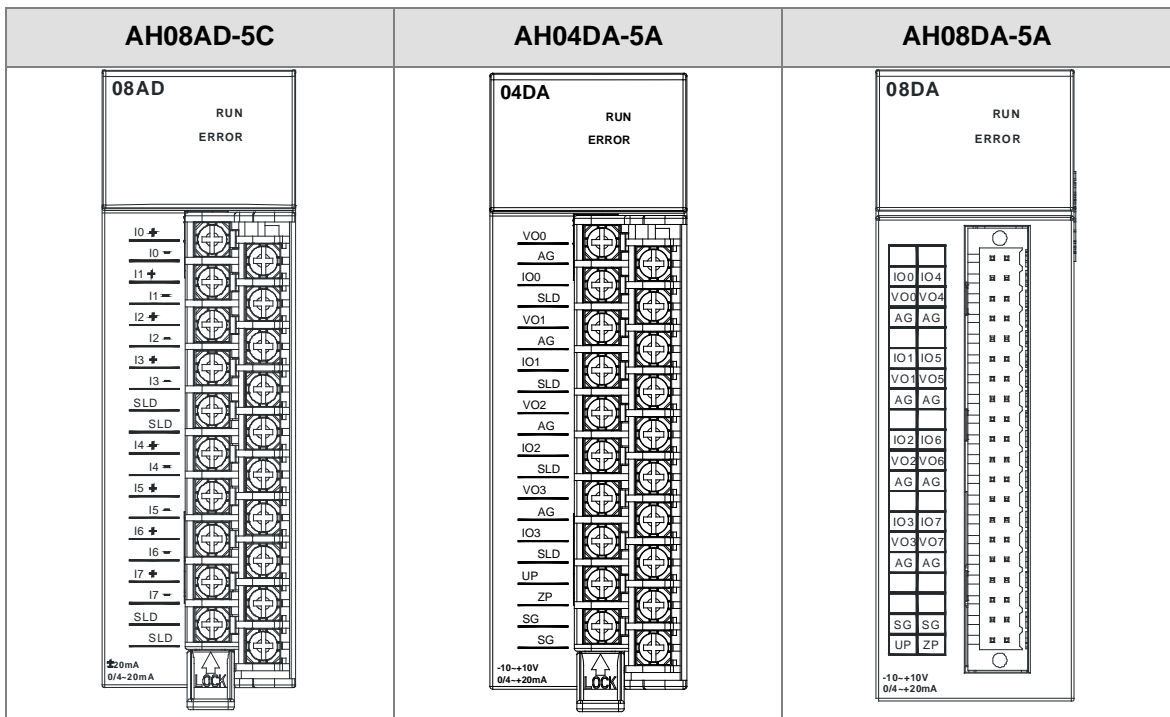

2

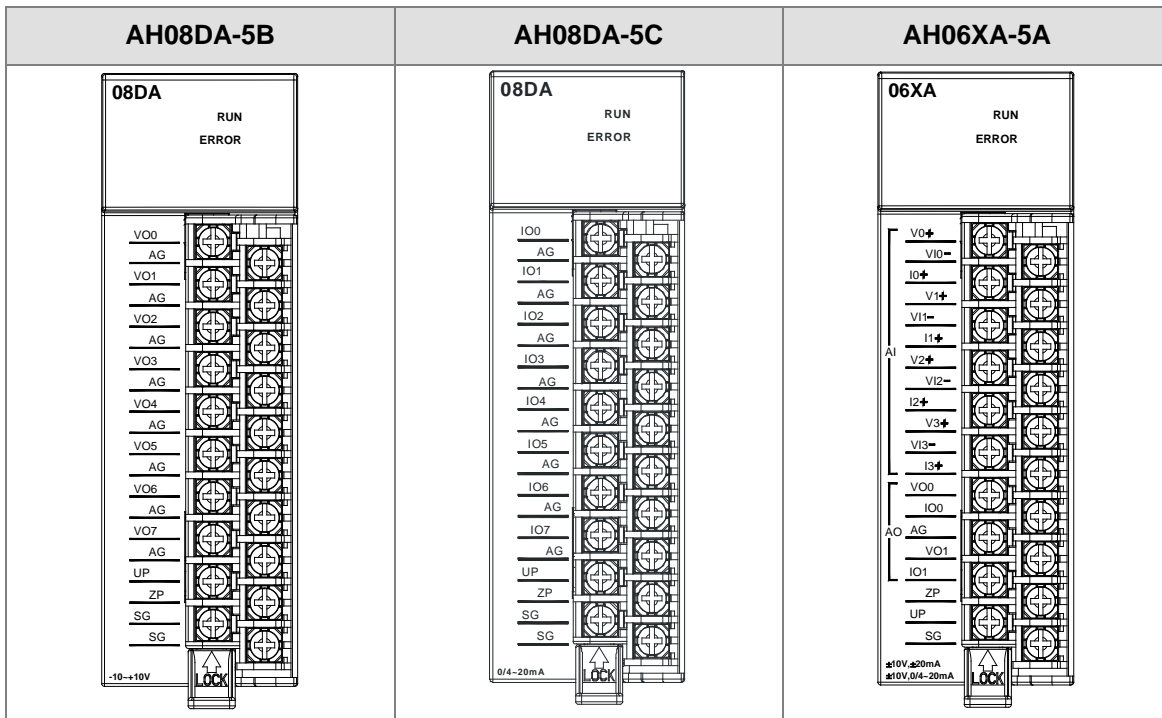

2.5.5 Setting Parameters

(1) AH04AD-5A

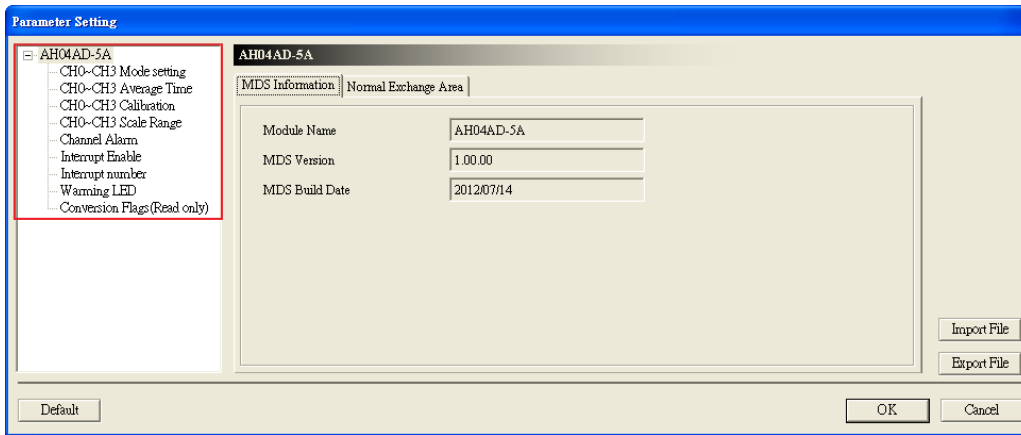

(2) AH08AD-5A

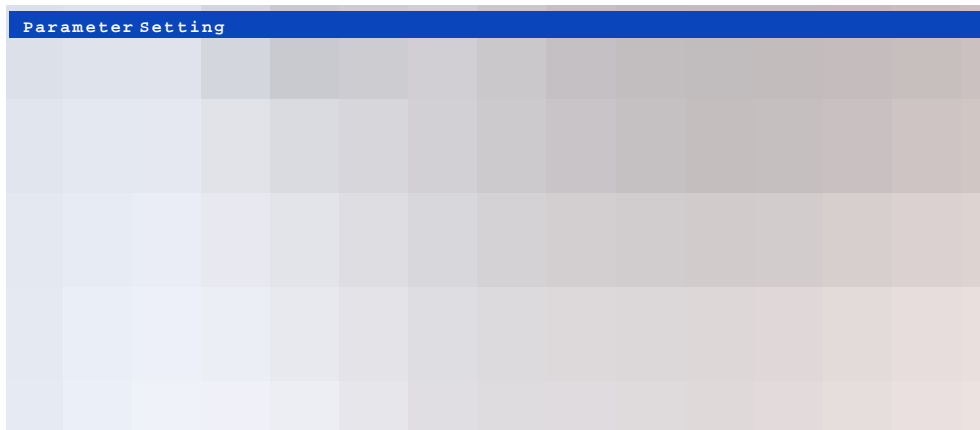

(3) AH08AD-5B

Parameter Setting

AH08AD-5B
 CH0-CH7 Mode Setting
 CH0-CH7 Average Time
 CH0-CH7 Calibration
 CH0-CH7 Scale Range
 Channel Alarm
 Interrupt Enable
 Interrupt number
 Warning LED
 Conversion Flags (Read only)

AH08AD-5B
 MDS Information | Normal Exchange Area

Module Name	AH08AD-5B
MDS Version	1.00.00
MDS Build Date	2012/07/14

(4) AH08AD-5C

Parameter Setting

AH08AD-5C
 CH0-CH7 Mode Setting
 CH0-CH7 Average Time
 CH0-CH7 Calibration
 CH0-CH7 Scale Range
 Channel Alarm
 Interrupt Enable
 Interrupt number
 Warning LED
 Conversion Flags (Read only)

AH08AD-5C
 MDS Information | Normal Exchange Area

Module Name	AH08AD-5C
MDS Version	1.00.00
MDS Build Date	2012/07/14

(5) AH04DA-5A

Parameter Setting

AH04DA-5A
 CH0-CH3 Mode setting
 CH0-CH3 Calibration
 CH0-CH3 Scale Range
 OutPut Hold
 Conversion Flags (Read only)

AH04DA-5A
 MDS Information | Normal Exchange Area

Module Name	AH04DA-5A
MDS Version	1.00.00
MDS Build Date	2012/07/14

2

(6) AH08DA-5A

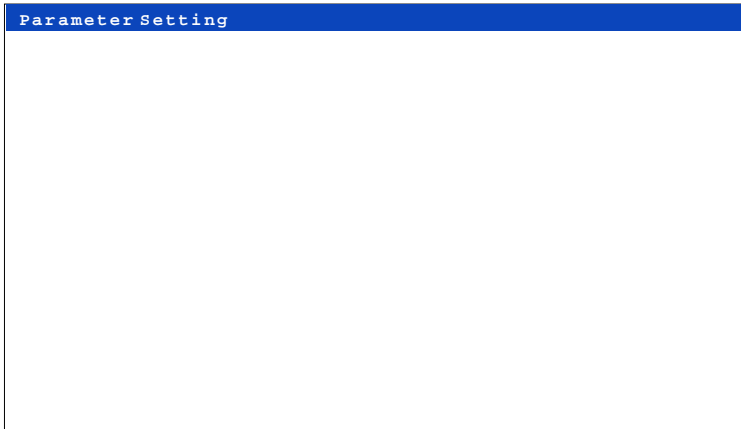

(7) AH08DA-5B

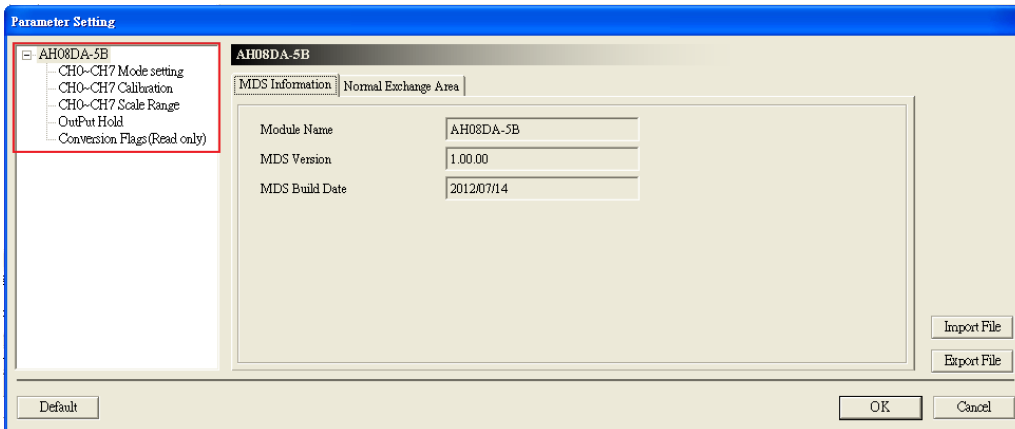

(8) AH08DA-5C

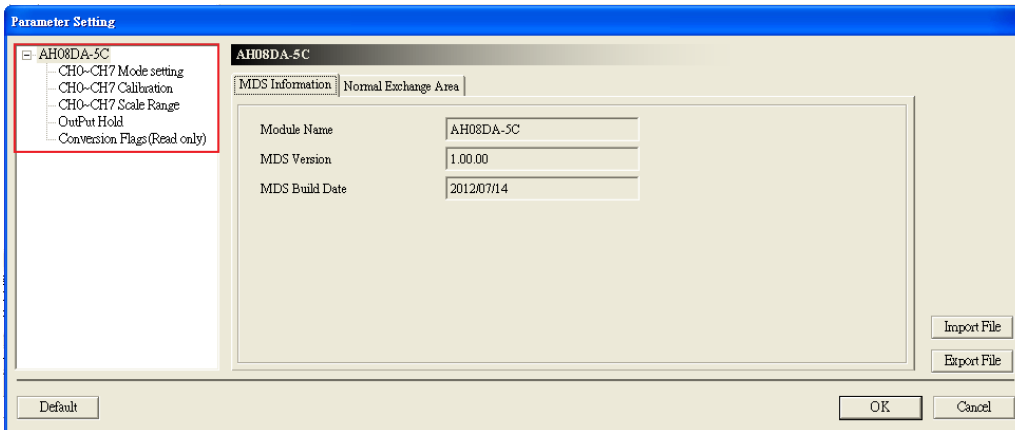

(9) AH06XA-5A

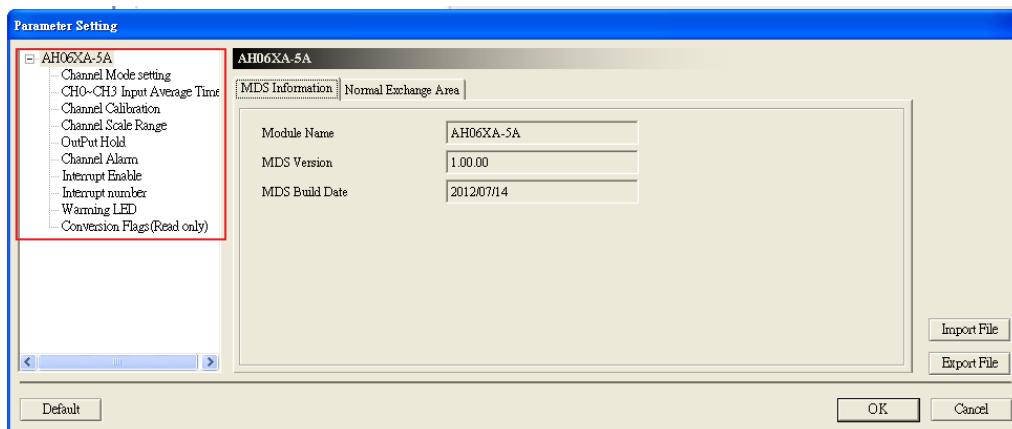

2

Please refer to AH500 Module Manual for more information about setting parameters.

2.6 Specifications for Temperature Measurement Modules

2.6.1 General Specifications

- AH04PT-5A

Electrical specifications

Number of analog inputs	4
Applicable sensor	Three-wire configuration: Pt100/Ni100/Pt1000/Ni1000 sensor, and 0~300 Ω input impedance Two-wire/Four-wire configuration: Pt100/Ni100/Pt1000/Ni1000 sensor, and 0~300 Ω input impedance Pt100: DIN 43760-1980 JIS C1604-1989; 100 Ω 3850 PPM/°C Pt1000: DIN EN60751; 1 kΩ 3850 PPM/°C Ni100/Ni1000: DIN 43760
Supply voltage	24 V DC (20.4 V DC~28.8 V DC) (-15%~+20%)
Connector type	Removable terminal block
Overall accuracy	25°C/77°F: The error is ±0.5% of the input within the range. -20~60°C/-4~140°F: The error is ±1% of the input within the range.
Conversion time	Two-wire/Four-wire Four-wire configuration: 150 ms/channel Three-wire configuration: 300 ms/channel
Isolation	An analog circuit is isolated from a digital circuit by a digital integrated circuit/an optocoupler, and the analog channels are isolated from one another by optocouplers. Isolation between a digital circuit and a ground: 500 V DC Isolation between an analog circuit and a ground: 500 V DC Isolation between an analog circuit and a digital circuit: 500 V DC Isolation between the 24 V DC and a ground: 500 V DC
Weight	195g

Functional specifications

Analog-to-digital conversion	Centigrade (°C)	Fahrenheit (°F)	Input impedance
Rated input range	Pt100: -180°C~800°C Ni100: -80°C~170°C Pt1000: -180°C~800°C Ni1000: -80°C~170°C	Pt100: -292°F~1,472°F Ni100: -112°F~338°F Pt1000: -292°F~1,472°F Ni1000: -112°F~338°F	0~300 Ω
Average function	Range: 1~100		
Self-diagnosis	Disconnection detection		

2

● AH08PTG-5A

Electrical specifications

Number of analog inputs	8
Applicable sensor	Three-wire configuration: Pt100/Ni100/Pt1000/Ni1000 sensor, and 0~300 Ω input impedance Two-wire/Four-wire configuration: Pt100/Ni100/Pt1000/Ni1000 sensor, and 0~300 Ω input impedance Pt100: DIN 43760-1980 JIS C1604-1989; 100 Ω 3850 PPM/°C Pt1000: DIN EN60751; 1 kΩ 3850 PPM/°C Ni100/Ni1000: DIN 43760
Supply voltage	24 V DC (20.4 V DC~28.8 V DC) (-15%~+20%)
Connector type	Removable terminal block
Overall accuracy	The error is ±1°C of a Pt100/Pt1000/Ni100/Ni1000 sensor's temperature. The error is ±0.1% of a resistance in the range of 0 Ω to 300 Ω.
Conversion time	<ul style="list-style-type: none"> Quick mode: <ul style="list-style-type: none"> Four-wire/Two-wire configuration: 20 ms/channel Three-wire configuration: 200 ms/channel General mode: A conversion time will be gotten after the conversion time of the two channels in a group is added up. <ul style="list-style-type: none"> Four-wire/Two-wire configuration: 200 ms/channel Three-wire configuration: 400 ms/channel
Isolation	An analog circuit is isolated from a digital circuit by a digital integrated circuit, and the analog channels are isolated from one another by optocouplers. Isolation between a digital circuit and a ground: 500 V DC Isolation between an analog circuit and a ground: 500 V DC Isolation between an analog circuit and a digital circuit: 500 V DC Isolation between two group circuits: 500 V DC Isolation between the 24 V DC and a ground: 500 V DC
Weight	255g

Functional specifications

Analog-to-digital conversion	Centigrade (°C)	Fahrenheit (°F)	Input impedance
Rated input range	Pt100: -180°C~800°C Ni100: -80°C~170°C Pt1000: -180°C~800°C Ni1000: -80°C~170°C	Pt100: -292°F~1,472°F Ni100: -112°F~338°F Pt1000: -292°F~1,472°F Ni1000: -112°F~338°F	0~300 Ω
Average function	Range: 1~100		
Self-diagnosis	Disconnection detection		

● AH04TC-5A/AH08TC-5A

Electrical specifications

Module name	AH04TC-5A	AH08TC-5A
Number of analog inputs	4	8
Applicable sensor	Type J, type K, type R, type S, type T, type E, and type N thermocouples ±150 mV voltage inputs	
Supply voltage	24 V DC (20.4 V DC~28.8 V DC) (-15%~+20%)	
Connector type	Removable terminal block	
Overall accuracy	25°C/77°F: The error is ±0.5% of the input within the range. -20~60°C/-4~140°F: The error is ±1% of the input within the range.	
Conversion time	200 ms/channel	
Isolation	An analog circuit is isolated from a digital circuit by a digital integrated circuit/an optocoupler, and the analog channels are isolated from one another by optocouplers.	

Module name	AH04TC-5A	AH08TC-5A
	Isolation between a digital circuit and a ground: 500 V DC Isolation between an analog circuit and a ground: 500 V DC Isolation between an analog circuit and a digital circuit: 500 V DC Isolation between the 24 V DC and a ground: 500 V DC Isolation between analog channels: 120 V AC	
Weight	190g	

Functional specifications

Analog-to-digital conversion	Centigrade (°C)	Fahrenheit (°F)	Voltage input
Rated input range	Type J: -100°C~1,150°C Type K: -100°C~1,350°C Type R: 0°C~1,750°C Type S: 0°C~1,750°C Type T: -150°C~390°C Type E: -150°C~980°C Type N: -150°C~1,280°C	Type J: -148°F~2,102°F Type K: -148°F~2,462°F Type R: 32°F~3,182°F Type S: 32°F~3,182°F Type T: -238°F~734°F Type E: -238°F~1,796°F Type N: -238°F~2,336°F	±150 mV
Average function	Range: 1~100		
Self-diagnosis	Disconnection detection		

2.6.2 Profiles

● AH04PT-5A/AH04TC-5A/AH08TC-5A

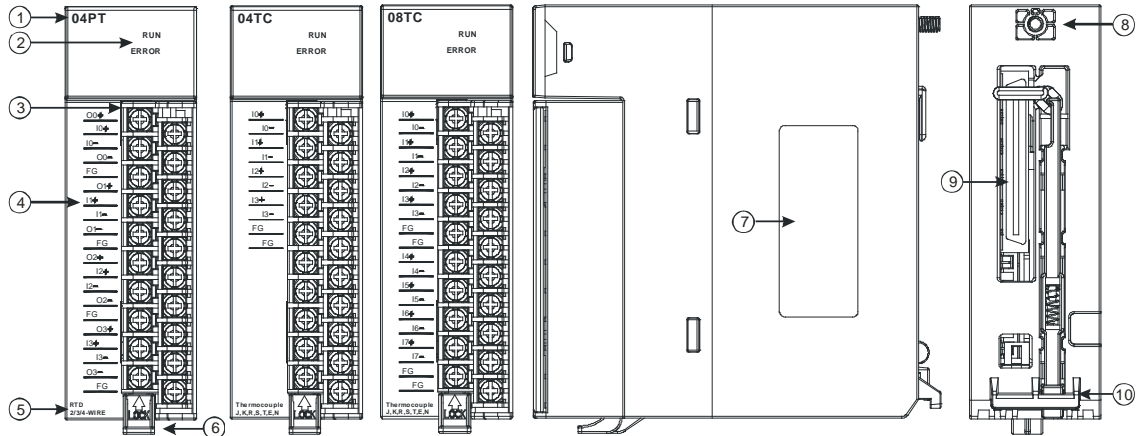

Number	Name	Description
1	Model name	Model name of the module
2	RUN LED indicator	Operating status of the module ON: The module is running. OFF: The module stops running.
	ERROR LED indicator	Error status of the module ON: A serious error occurs in the module. OFF: The module is normal. Blinking: A slight error occurs in the module.
3	Removable terminal block	The inputs are connected to a sensor.
4	Arrangement of the input/output terminals	Arrangement of the terminals
5	Description of the inputs/outputs	Simple specifications for the module
6	Clip	Removing the terminal block
7	Label	Nameplate

Number	Name	Description
8	Set screw	Fixing the module
9	Connector	Connecting the module and a backplane
10	Projection	Fixing the module

2

● AH08PTG-5A

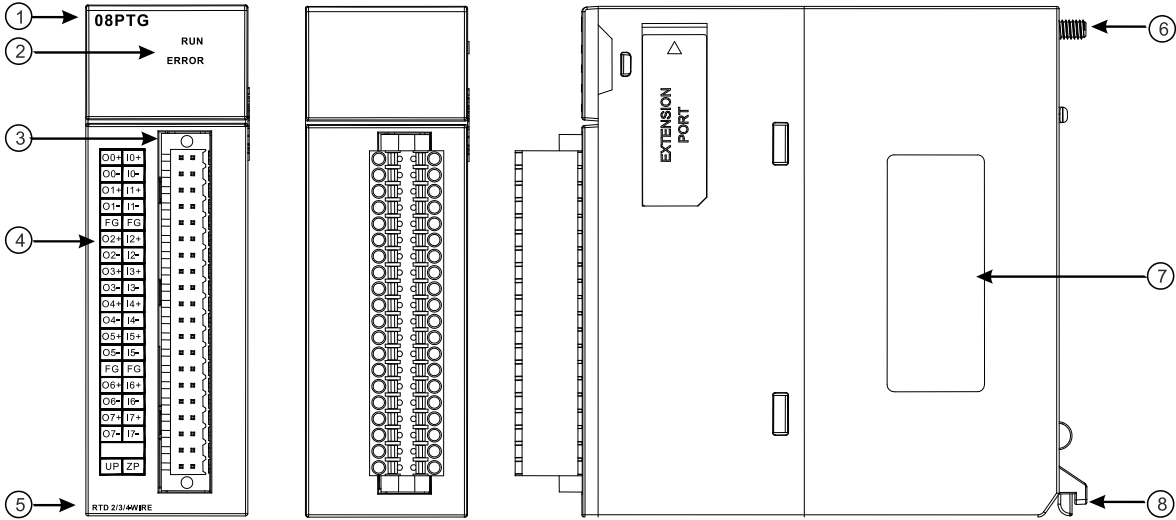

Number	Name	Description
1	Model name	Model name of the module
2	RUN LED indicator	Operating status of the module ON: The module is running. OFF: The module stops running.
2	ERROR LED indicator	Error status of the module ON: A serious error occurs in the module. OFF: The module is normal. Blinking: A slight error occurs in the module.
3	Removable terminal block	The inputs are connected to a sensor.
4	Arrangement of the input terminals	Arrangement of the terminals
5	Description of the inputs	Simple specifications for the module
6	Set screw	Fixing the module
7	Label	Nameplate
8	Projection	Fixing the module

2.6.3 Dimensions

● AH04PT-5A/AH04TC-5A/AH08TC-5A

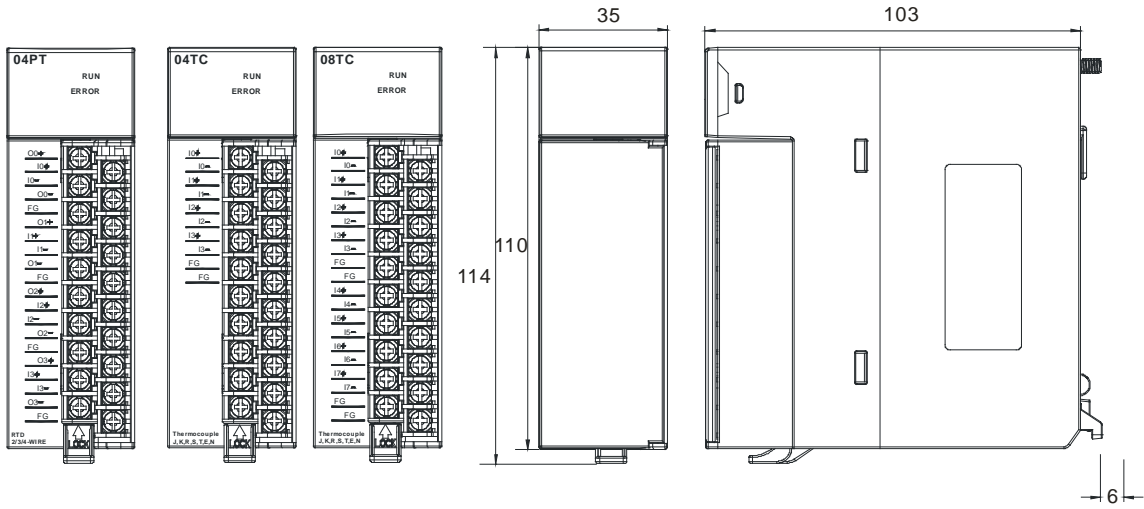

2

Unit: mm

● AH08PTG-5A

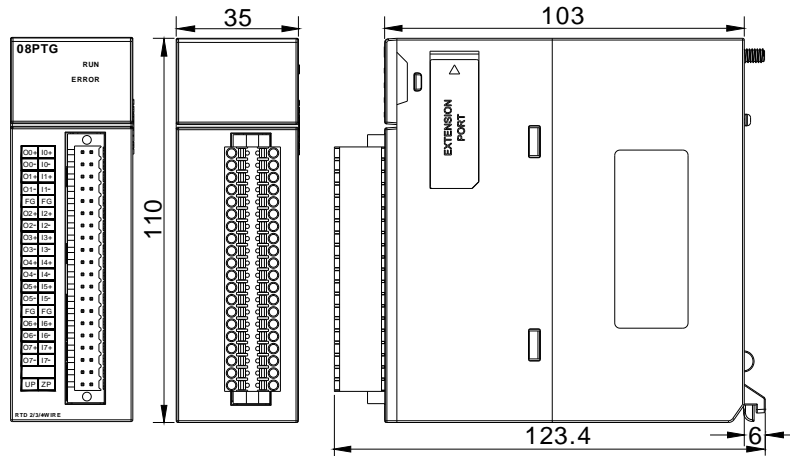

Unit: mm

2.6.4 Arrangement of Input/Output Terminals

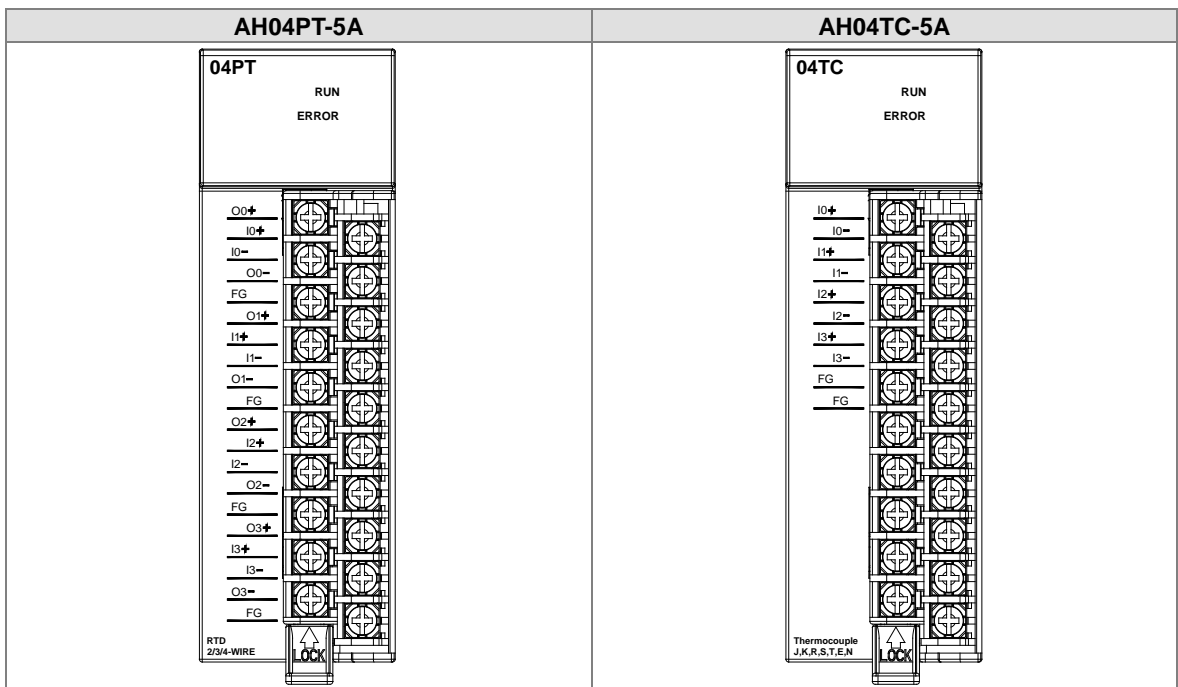

2

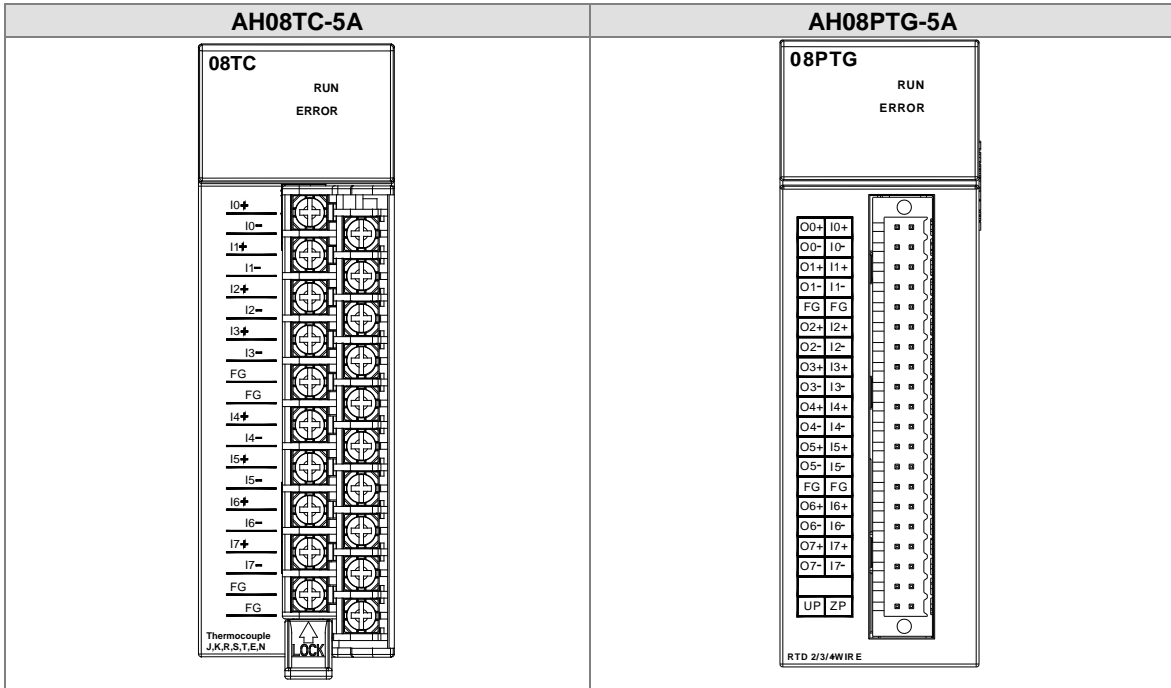

2.6.5 Setting Parameters

(1) AH04PT-5A

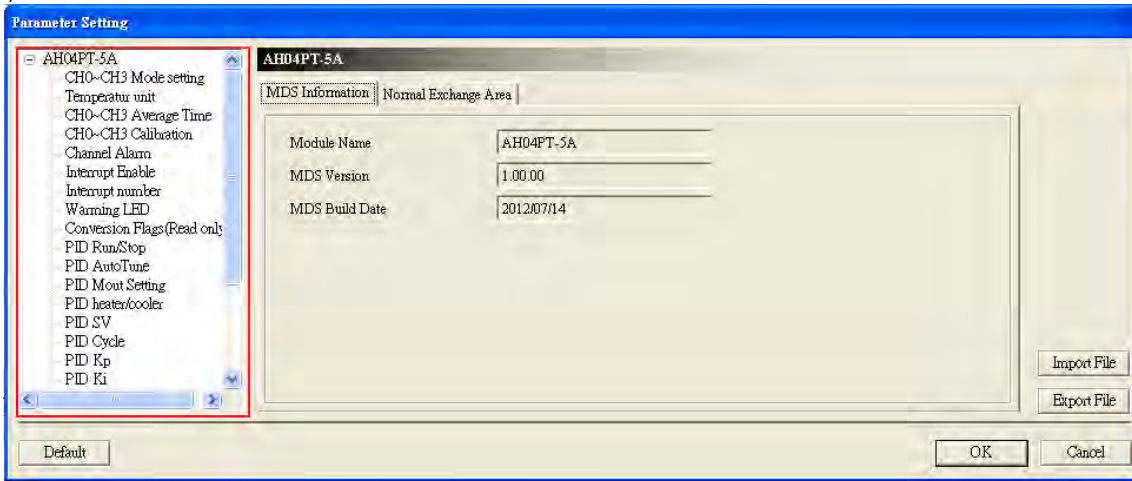

(2) AH08PTG-5A



(3) AH04TC-5A

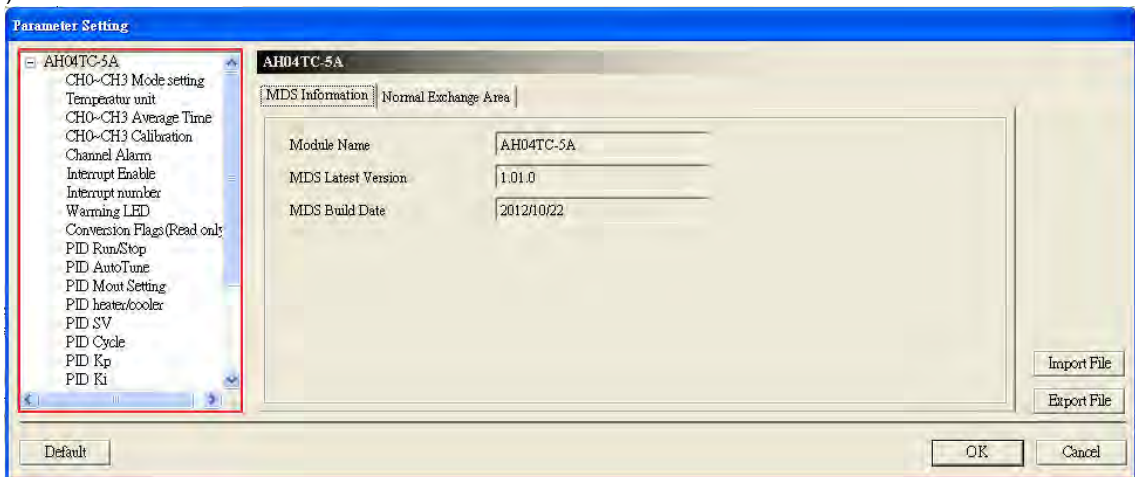

(4) AH08TC-5A

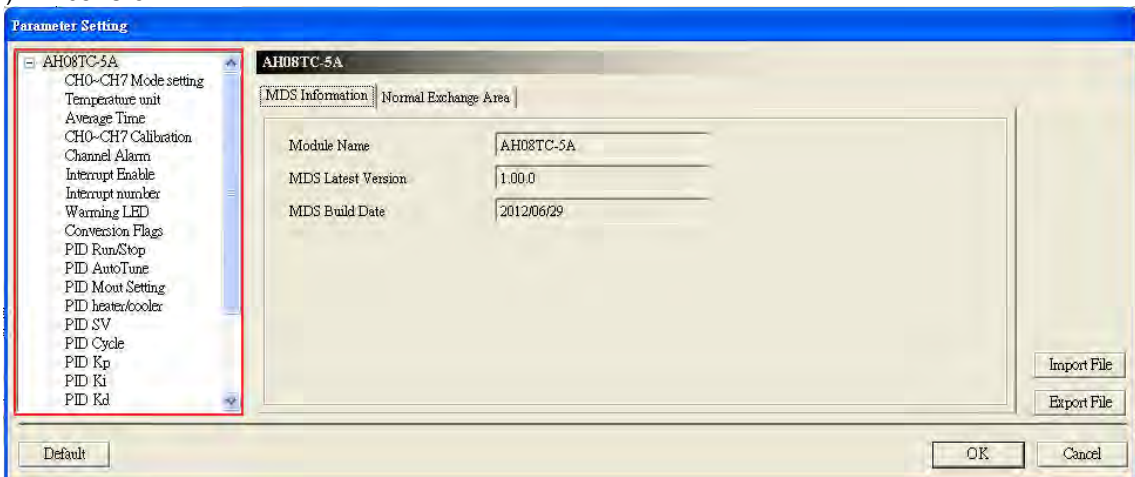

Please refer to AH500 Module Manual for more information about setting parameters.

2.7 Specifications for Network Modules

2.7.1 General Specifications

- **AH10SCM-5A**

Functional specifications

- **RS-485/RS-422 communication interface**

Item	Specifications
Connector type	European-style terminal block
Transmission speed	1,200, 2,400, 4,800, 9,600, 19,200, 38,400, 57,600, 76,800, 115,200, 230,400, and 460,800 bps (bit/seconds)
Communication format	Stop bit: 1 stop bit or 2 stop bits Parity bit: none, an odd parity bit, or an even parity bit Data bit: 7 data bits or 8 data bits
Communication protocol	Modbus ASCII/RTU UD Link BACnet MS/TP slave stations

- **Electrical specifications**

Item	Specifications
Supply voltage	5 V DC
Electric energy consumption	1.5 W
Insulation voltage	2,500 V DC
Weight	131 g

- **AH15SCM-5A**

- **RS-232 communication interface**

Item	Specifications
Connector type	DB9 connector
Transmission speed	1200, 2400, 4800, 9600, 19200, 38400, 57600, 76800 and 115200 bps
Communication format	Stop bit: 1 stop bit or 2 stop bits Parity bit: none, an odd parity bit, or an even parity bit Data bit: 7 data bits or 8 data bits
Communication protocol	Modbus ASCII/RTU UD Link BACnet MS/TP slave stations

- **Electrical specifications**

Item	Specifications
Supply voltage	5 VDC
Electric energy consumption	1.5 W
Insulation voltage	2,500 VDC
Weight	150g

- **AH10EN-5A**

- **Network interface**

Item	Specifications
Connector type	RJ-45 with auto-MDI/MDIX
Transmission interface	802.3 and 802.3u
Transmission cable	Category 5e cable The maximum length is 100 meters.
Transmission speed	10/100 Mbps auto-detection

Communication protocol	ICMP, IP, TCP, UDP, DHCP, NTP, Modbus TCP, SNMP, and SMTP
-------------------------------	-----------------------------------------------------------

■ **Electrical specifications**

Item	Specifications
Supply voltage	5 V DC
Electric energy consumption	1.5 W
Insulation voltage	2,500 V DC
Weight	139 g

● **AH10DNET-5A**

■ **AH500 series CPU modules which are supported**

Item	Specifications
Model name	AH500 series PLCs

■ **DeviceNet interface**

Item	Specifications
Transmission method	CAN
Electrical isolation	500 V DC
Connector	Removable connector (5.08 mm)
Communication cable	The Delta standard cables UC-DN01Z-01A and UC-DN01Z-02A are recommended. The communication cable should be away from the power cable and the shielded cable should be connected to the ground.
Voltage	DeviceNet network provides 11~25 V direct current. e.g. 28 mA (Typical value), 125 mA impulse current (24 V DC).

■ **DeviceNet Communication**

Item	Specifications
Message type	Master mode: Supporting explicit messages, and all kinds of I/O connections with the slave such as I/O polled connections, bit-strobed connections, state changing connections, and cyclic connections Slave mode: Supporting explicit messages and a group 2 only server
Transmission speed	Standard: 125 kbps, 250 kbps and 500 kbps Extension: 10 kbps, 20 kbps, 50 kbps, 125 kbps, 250 kbps, 500 kbps, 800 kbps and 1M bps
Weight	135g

● **AH10PFBM-5A**

■ **AH500 series CPU module supported**

Item	Specifications
Model name	AH500 series PLCs

■ **PROFIBUS-DP interface**

Item	Specifications
Interface	DB9 connector
Transmission method	High-speed RS-485
Transmission cable	Two-wire twisted shielded cable
Electrical isolation	500 V DC

■ **PROFIBUS-DP communication**

Item	Specifications
Message type	Cyclic data exchange

2

Module name	AH10PFBM-5A
Product ID	0B49
Serial transmission speed supported (auto-detection)	9.6 kbps; 19.2 kbps; 31.25 kbps; 45.45 kbps; 93.75 kbps; 187.5 kbps; 500 kbps; 1.5 Mbps; 3 Mbps; 6 Mbps; 12 Mbps

- **Electrical specification**

Item	Specifications
Power supply voltage	5 V DC
Insulation voltage	500 V DC
Power consumption	2 W
Weight	190 g

- **AH10PFBS-5A**

- **PROFIBUS-DP port**

Interface	DB9 connector
Transmission method	High-speed RS-485
Transmission cable	Shielded twisted pair cable
Electrical isolation	500 V DC

- **Communication**

Message type	Cyclic data exchange
Module name	AH10PFBS-5A
GSD file	DELA0AFE.GSD
Product ID	0AFE
Serial transmission speed supported (auto-detection)	9.6 kbps; 19.2 kbps; 45.45 (31.25) kbps; 93.75 kbps; 187.5 kbps; 500 kbps; 1.5 Mbps; 3 Mbps; 6 Mbps; 12 Mbps

- **Electrical specification**

Power supply voltage	5 V DC
Insulation voltage	500 V DC
Power consumption	2 W
Weight	115 g

- **AH10COPM-5A**

- **CANopen interface**

Item	Specifications
Transmission method	CAN
Electrical isolation	500 V DC
Connector	Removable connector (5.08 mm)
Communication cable	It is suggested that users should use the Delta standard cables UC-DN01Z-01A and UC-DN01Z-02A. The communication cable used should be away from the power cable used, and the shielded cables used should be connected to the ground.

- **CANopen communication**

Item	Specifications
Message type	PDO, SDO, SYNC, EMCY, NMT
Transmission speed	10 kbps, 20 kbps, 50 kbps, 125 kbps, 250 kbps, 500 kbps, 800 kbps, 1 Mbps

■ Electrical specifications

Item	Specifications
Supply voltage	A CPU module supplies 24 V DC (-15%~20%) power through an internal bus.
Electric energy consumption	1.7 W
Insulation voltage	500 V
Weight	150g

2.7.2 Profiles

● AH10SCM-5A

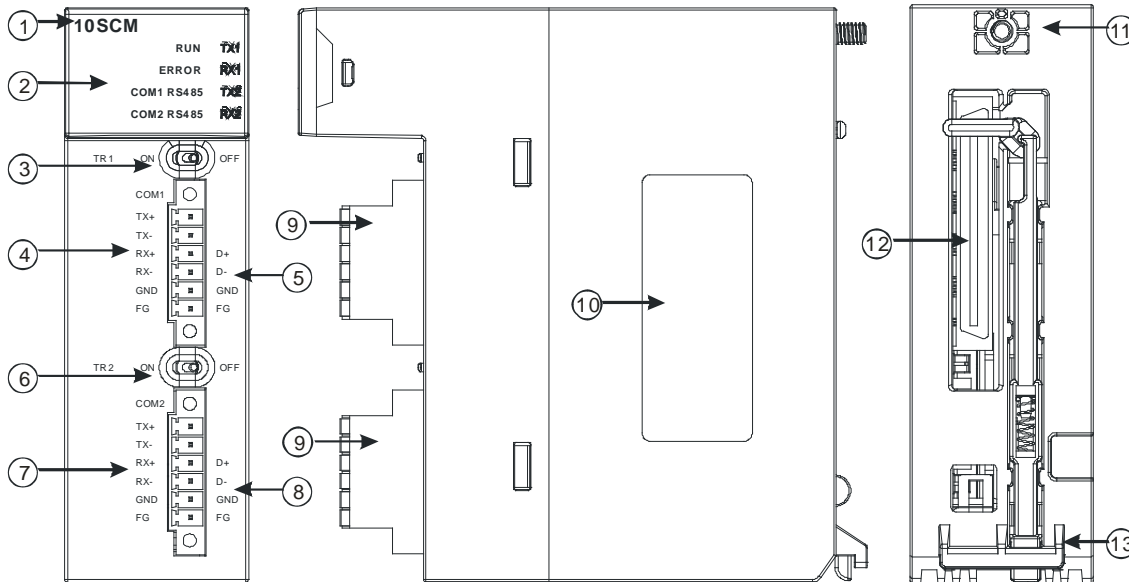

Number	Name	Description
1	Model name	Model name of the module
2	RUN LED indicator (green)	Operating status of the module ON: The module is running. OFF: The module stops running.
	ERROR LED indicator (red)	Error status of the module ON: There is a hardware error. OFF: The module is normal. Blinking: 1. The setting of the module is incorrect, or there is a communication error. 2. Restoring the module to the default factory value
	COM1 (RS-485) LED indicator (green)	ON: RS-485 mode OFF: RS-422 mode
	COM2 (RS-485) LED indicator (green)	ON: RS-485 mode OFF: RS-422 mode
	TX1/TX2 LED indicator (orange)	Blinking: The data is being transmitted through the RS-485/RS422 port. OFF: The data is not being transmitted through the RS-485/RS422 port.
3	Switch of terminal resistor 1	Switching terminal resistor 1 ON/OFF
	4	Terminals

2

Number	Name	Description
5	Terminals	Terminals for COM1 (RS-485)
6	Switch of terminal resistor 2	Switching terminal resistor 2 ON/OFF
7	Terminals	Terminals for COM2 (RS-422)
8	Terminals	Terminals for COM2 (RS-485)
9	European-style terminal block	Terminals for wiring
10	Label	Nameplate
11	Set screw	Fixing the module
12	Connector	Connecting the module and a backplane
13	Projection	Fixing the module

● AH15SCM-5A

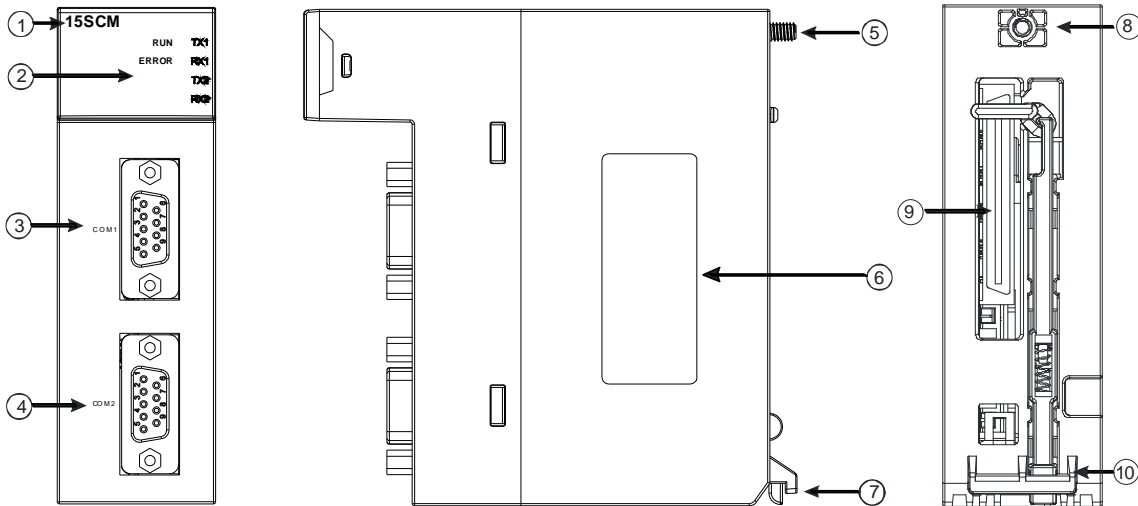

Number	Name	Description
1	Model name	Model name of the module
2	RUN LED indicator (green)	Operating status of the module ON: The module is running. OFF: The module stops running.
	ERROR LED indicator (red)	Error status of the module ON: There is a hardware error. OFF: The module is normal. Blinking: 1. The setting of the module is incorrect, or there is a communication error. 2. Restoring the module to the default factory value
	COM1 (RS-485) LED indicator (green)	ON: RS-485 mode OFF: RS-422 mode
	COM2 (RS-485) LED indicator (green)	ON: RS-485 mode OFF: RS-422 mode
	TX1/TX2 LED indicator (orange)	Blinking: The data is being transmitted through the RS-232 port. OFF: The data is not being transmitted through the RS-232 port.
2	RX1/RX2 LED indicator (orange)	Blinking: The data is being received through the RS-232 port. OFF: The data is not being received through the RS-232 port.
	3	Terminals
4	Terminals	Terminals for COM2 (RS-232)

Number	Name	Description
5	Set screw	Fixing the module
6	Label	Nameplate
7	Projection	Fixing the module
8	Set screw	Fixing the module
9	Connector	Connecting the module and a backplane
10	Projection	Fixing the module

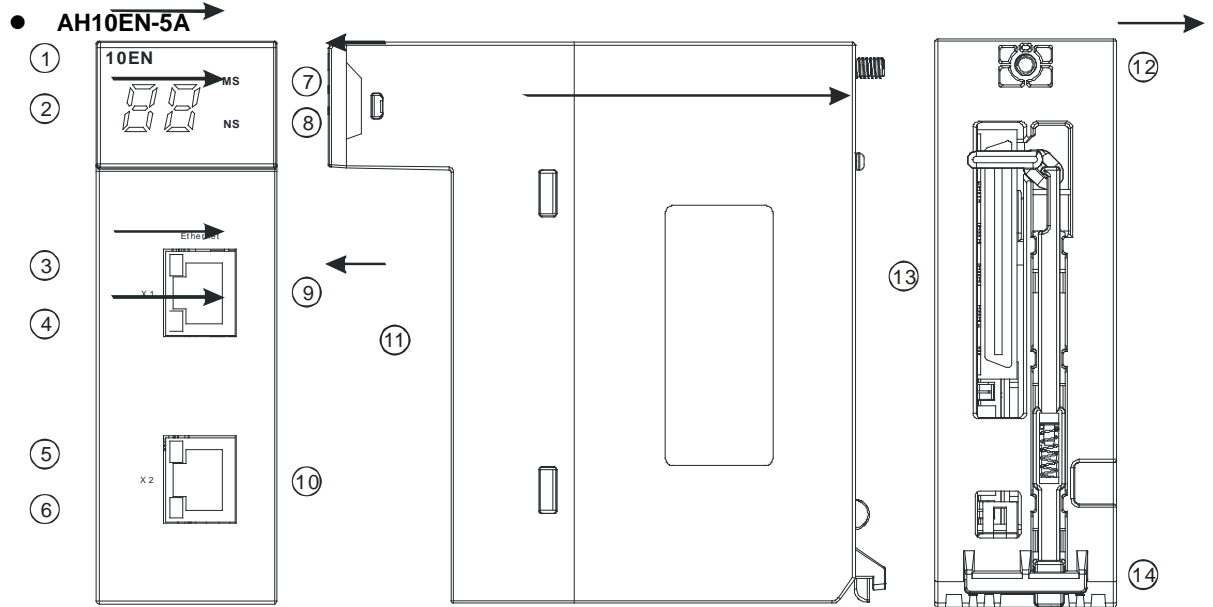

Number	Name	Description
1	Model name	Model name of the module
2	Seven-segment display	Display
3	LINK LED indicator	LINK LED indicator for RJ45 port 1
4	ACK LED indicator	ACK LED indicator for RJ45 port 1
5	LINK LED indicator	LINK LED indicator for RJ45 port 2
6	ACK LED indicator	ACK LED indicator for RJ45 port 2
7	NS LED indicator	LED indicator
8	MS LED indicator	LED indicator
9	RJ45 port 1	RJ45 port 1
10	RJ45 port 2	RJ45 port 2
11	Label	Nameplate
12	Set screw	Fixing the module
13	Connector	Connecting the module and a backplane
14	Projection	Fixing the module

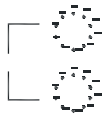

2

● AH10DNET-5A

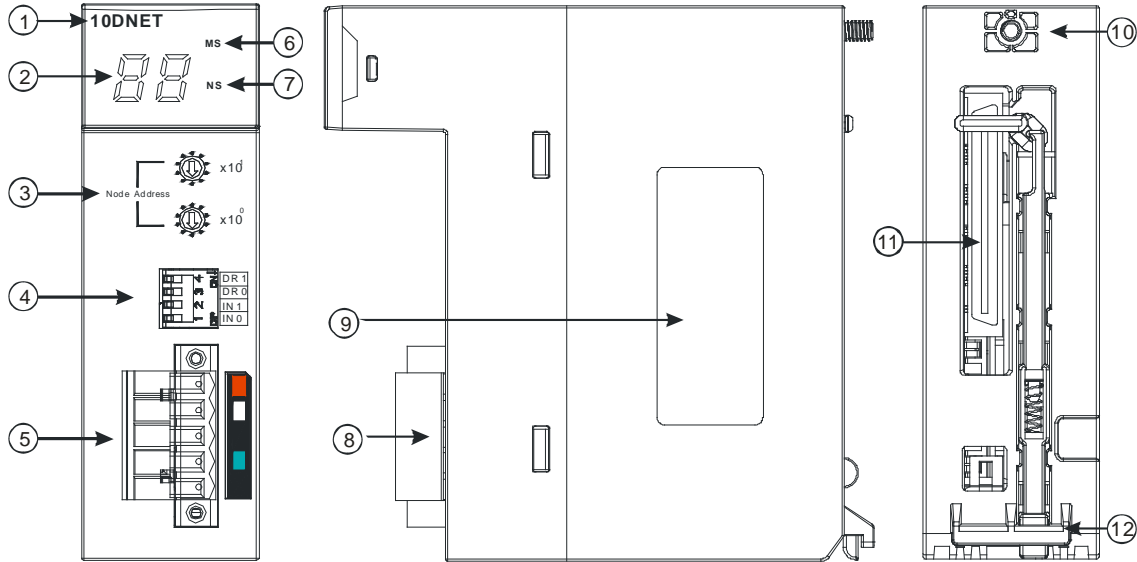

Number	Name	Description
1	Model name	Model name of the module
2	Seven-segment display	Display
3	Address knob	Setting the address
4	Function switch	Setting the functions
5	DeviceNet connector	DeviceNet is used to interconnect control devices for data exchange.
6	MS LED indicator	Indicating the status of the module
7	NS LED indicator	Indicating the status of the network
8	Removable terminal block	Terminals for wiring
9	Label	Nameplate
10	Set screw	Fixing the module
11	Connector	Connecting the module and a backplane.
12	Projection	Fixing the module

1. Address knobs

It is used to set the node address of AH10DNET-5A on a DeviceNet network. (Node addresses range from 0 to 63.)

Setting	Description
0...63	Available nodes on a DeviceNet network
64...99	Unavailable nodes on a DeviceNet network

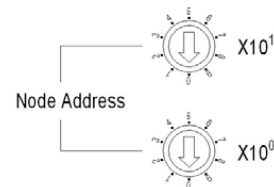

Example: If users want to set the communication address of AH10DNET-5A to 26, they can turn the knob corresponding to $x10^1$ to 2, and turn the knob corresponding to $x10^0$ to 6.

Points for attention:

- After the station address of AH10DNET-5A is changed, users have to power AH10DNET-5A again, otherwise the change will not take effect.
- Please use a slotted screwdriver to turn the knobs with care, and do not scrape them.

2. Function switch

The function switch provides the following functions:

- Setting the working mode (IN 0)
- Setting the transmission speed of a DeviceNet network (DR 0~DR 1)

DR 1	DR 0	Transmission speed
OFF	OFF	125 kbps
OFF	ON	250 kbps
ON	OFF	500 kbps
ON	ON	Entering the extendable serial transmission speed mode
IN 1 Reserved		
IN 0	ON	If the slave is disconnected, the previous I/O data is retained.
	OFF	If the slave is disconnected, the previous I/O data is cleared.

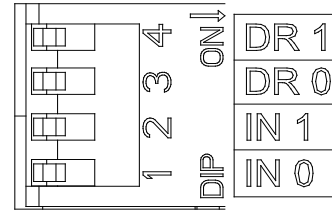

2

Points for attention:

- After the setting of the function switch of AH10DNET-5A is changed, users have to power AH10DNET-5A again, otherwise the change will not take effect.
- Please use a slotted screwdriver to adjust the DIP switch with care, and do not scrape them.

3. DeviceNet connector

Pin	Signal	Color	Description
5	V+	Red	24 V DC
4	CAN_H	White	Signal (positive pole)
3	SHIELD	-	It is connected to a shielded cable.
2	CAN_L	Blue	Signal (negative pole)
1	V-	Black	0 V DC

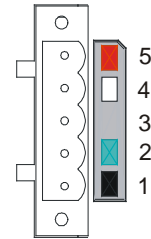

● **AH10PFBM-5A**

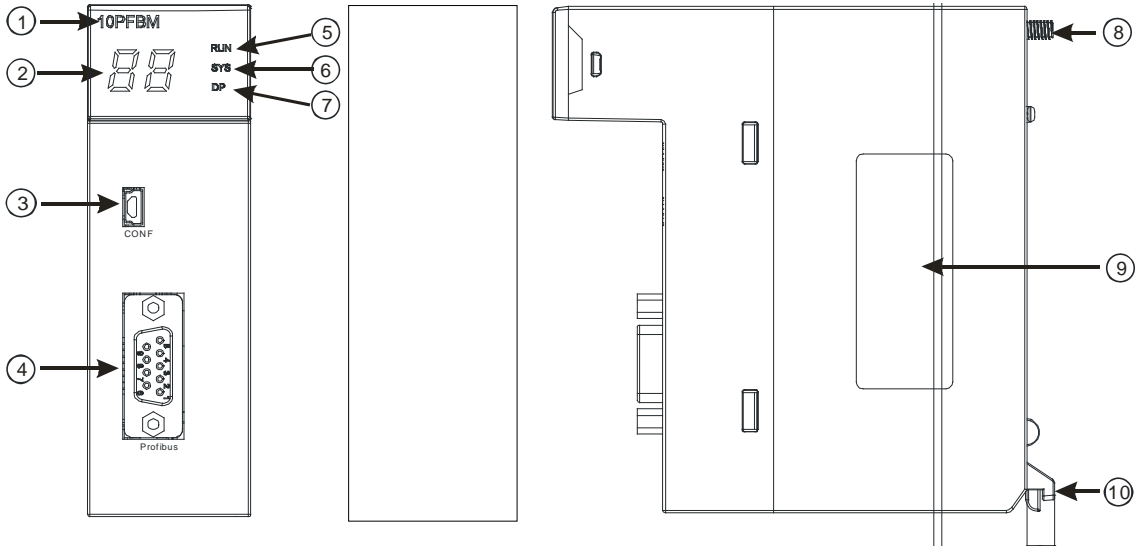

Number	Name	Description
1	Model name	Model name of the module
2	Seven-segment display	Display
3	CONF interface	The interface where the hardware configuration is downloaded
4	PROFIBUS-DP interface	PROFIBUS-DP connection
5	RUN LED indicator	LED indicator
6	SYS LED indicator	LED indicator
7	DP LED indicator	LED indicator

2

Number	Name	Description
8	Set screw	Fixing the module
9	Label	Nameplate
10	Projection	Fixing the module

1. PROFIBUS-DP port

A PROFIBUS-DP port is used to connect a module to a PROFIBUS-DP network. Users can wire AH10PFBS-5A by using the connector attached to AH10PFBS-5A.

Pin	PIN name	Description
1	--	N/C
2	--	N/C
3	RxD/TxD-P	Receiving/Sending data (P (B))
4	--	N/C
5	DGND	Data reference potential (C)
6	VP	Supplying positive voltage
7	--	N/C
8	RxD/TxD-N	Receiving/Sending data (N (A))
9	--	N/C

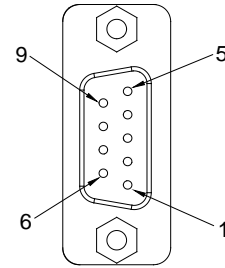

● AH10PFBS-5A

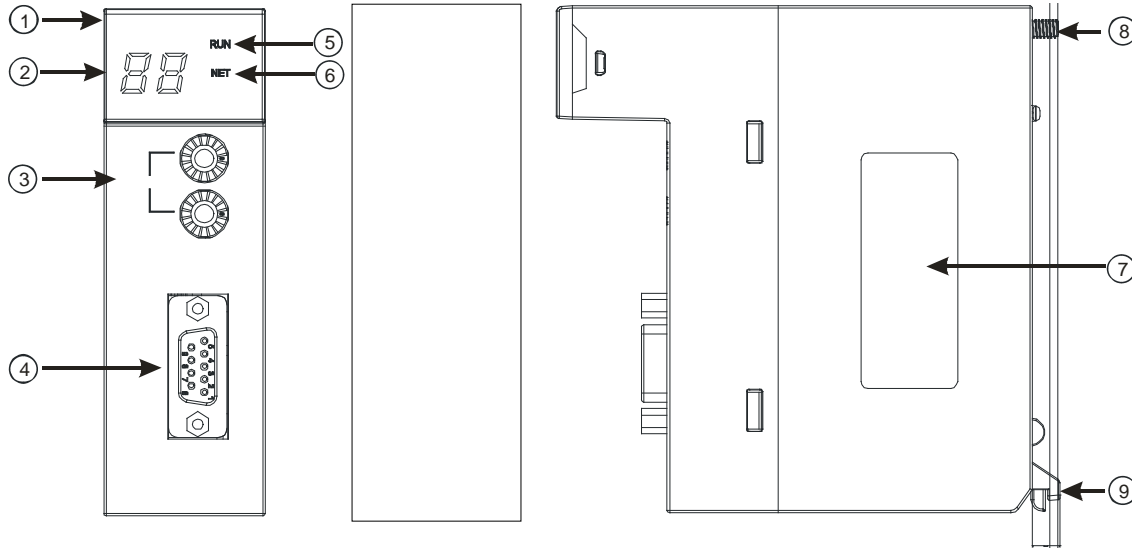

Number	Name	Description
1	Model name	Model name of the module
2	Seven-segment display	Display
3	Address knobs	Setting the address
4	PROFIBUS-DP interface	PROFIBUS-DP connection
5	RUN LED indicator	Operating status of the module
6	NET LED indicator	Status of a network
7	Label	Nameplate
8	Set screw	Fixing the module
9	Projection	Fixing the module

1. Setting a PROFIBUS node address

The address knobs of AH10PFBS-5A are used for setting the node address of AH10PFBS-5A on a PROFIBUS-DP network. There are two address knobs. They are a knob corresponding to $x16^0$, and a knob corresponding to $x16^1$. The range for one address knob is 0~F.

The range for setting the node address is described below.

Address	Definition
H'1~H'7D	Valid PROFIBUS address
H'0 or H'7E~H'FF	Invalid PROFIBUS address

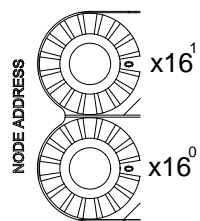

Example: If users need to set the node address of AH10PFBS-5A to 26 (decimal value), they have to turn the knob corresponding to $x16^1$ to "1", and the knob corresponding to $x16^0$ to "A".
 26 (decimal value) = $1A$ (hexadecimal value) = $1x16^1 + Ax16^0$.

Points for attention:

- If users set the node address of AH10PFBS-5A when AH10PFBS-5A is not supplied with power, they have to power AH10PFBS-5A after the node address of AH10PFBS-5A is set.
- If users change the node address of AH10PFBS-5A when AH10PFBS-5A is powered, the change will not take effect immediately after the node address of AH10PFBS-5A is changed, and it will take effect after the users cut off the power supplied to AH10PFBS-5A and then power AH10PFBS-5A again.
- To prevent the address knobs on AH10PFBS-5A from being scratched, please carefully use a slotted screwdriver to rotate the address knobs on AH10PFBS-5A.

2

2. Definitions of the pins in the PROFIBUS-DP port

Pin	PIN name	Description
1	--	N/C
2	--	N/C
3	RxD/TxD-P	Sending/receiving data (P (B))
4	--	N/C
5	DGND	Data reference potential (C)
6	VP	Supplying positive voltage
7	--	N/C
8	RxD/TxD-N	Sending/receiving data (N (A))
9	--	N/C

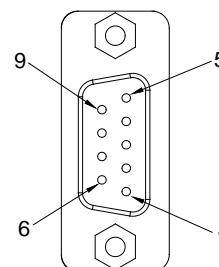

● **AH10COPM-5A**

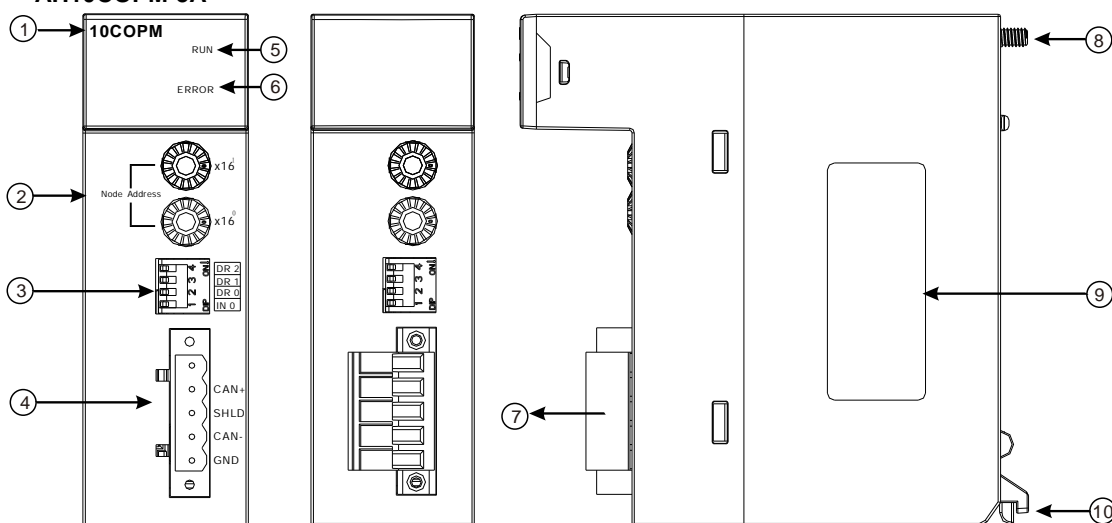

Number	Name	Description
1	Model name	Model name of the module
2	Address knobs	For setting an address
3	Function switch	For setting a function
4	CANopen connector	For a CANopen connection
5	RUN LED indicator	Operating status of the module

2

Number	Name	Description
6	ERROR LED indicator	Error status of the module
7	Removable terminal block	Terminals
8	Set screw	Fixing the module
9	Label	Nameplate
10	Projection	Fixing the module

1. CANopen communication connector

A CANopen connector is connected to a CANopen network. Please wire AH10COPM-5A by using the connector attached to AH10COPM-5A.

Pin	Signal	Description
5	-	Reserved
4	CAN+	CAN_H
3	SHLD	Shielded cable
2	CAN-	CAN_L
1	GND	0 V DC

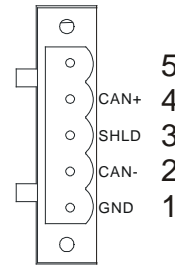

2. Address knobs

The address knobs on AH10COPM-5A are used to set the node address of AH10COPM-5A on a CANopen network. Setting range: 1~7F (0 and 80~FF can not be used.)

Setting	Description
1~7F	Valid CANopen node address
0, 80~FF	Invalid CANopen node address

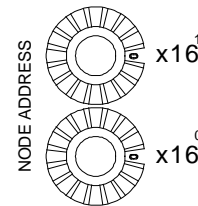

Example: If the station address of AH10COPM-5A is 16#26, users have to turn the knob corresponding to $x16^1$ to position 2, and turn the knob corresponding to $x16^0$ to position 6.

Points for attention:

- After the station address of AH10COPM-5A is changed, users have to power AH10COPM-5A again, otherwise the change will not take effect.
- To prevent the address knobs on AH10COPM-5A from being scratched, please carefully use a slotted screwdriver to rotate the address knobs on AH10COPM-5A.

3. Function switch

The function switch on AH10COPM-5A is used to set the communication speed at which AH10COPM-5A is connected to a CANopen network. There is a limit on the maximum communication distance to which a communication speed corresponds.

DR 2	DR 1	DR 0	Communication speed	Maximum communication distance
OFF	OFF	OFF	10 kbps	5000 m
OFF	OFF	ON	20 kbps	2500 m
OFF	ON	OFF	50 kbps	1000 m
OFF	ON	ON	125 kbps	500 m
ON	OFF	OFF	250 kbps	250 m
ON	OFF	ON	500 kbps	100 m
ON	ON	OFF	800 kbps	50 m
ON	ON	ON	1 Mbps	25 m
IN 0				Reserved

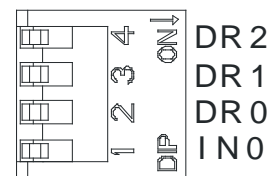

Points for attention:

- After users change the communication speed at which AH10COPM-5A is connected to a CANopen network, they have to power AH10COPM-5A again, otherwise the change will not take effect.
- To prevent the DIP switch on AH10COPM-5A from being scratched, please carefully use a slotted screwdriver to rotate the DIP switch on AH10COPM-5A.

2.7.3 Dimensions

● **AH10SCM-5A**

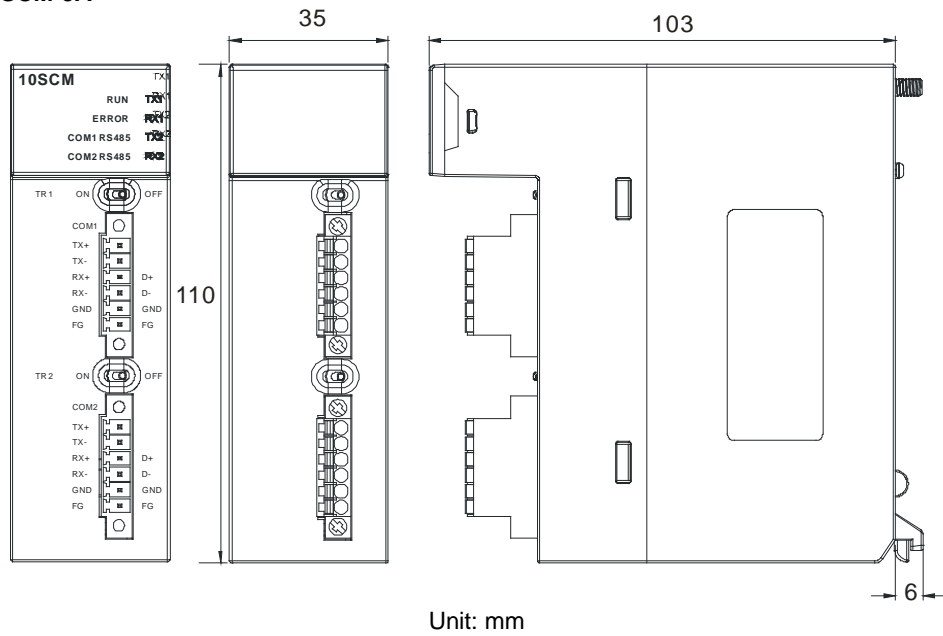

● **AH15SCM-5A**

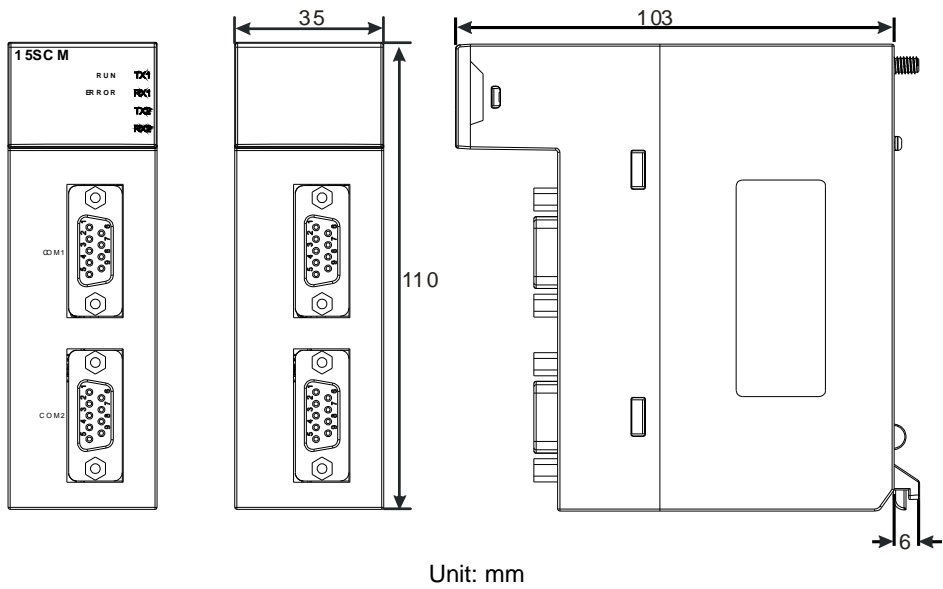

2

● AH10EN-5A

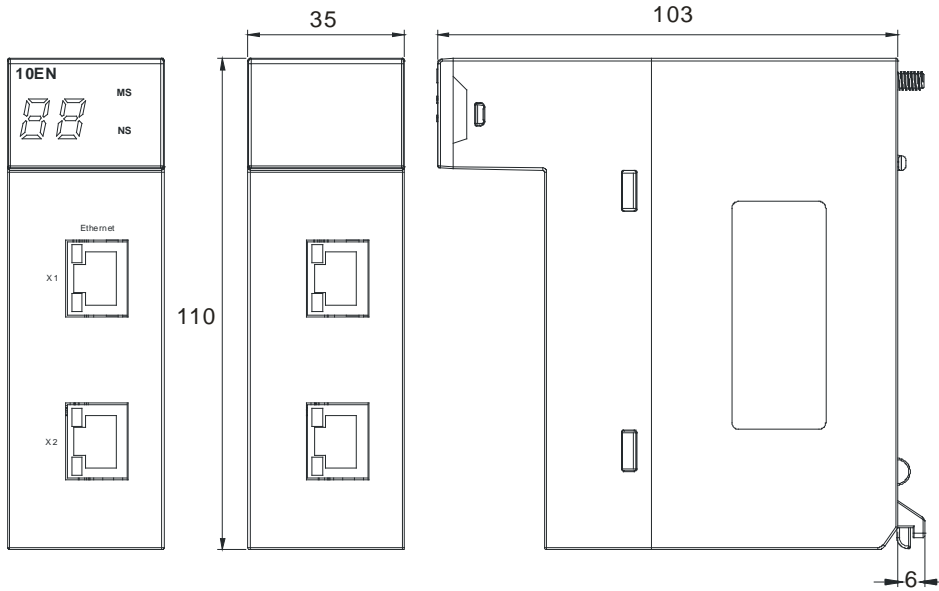

Unit: mm

● AH10DNET-5A

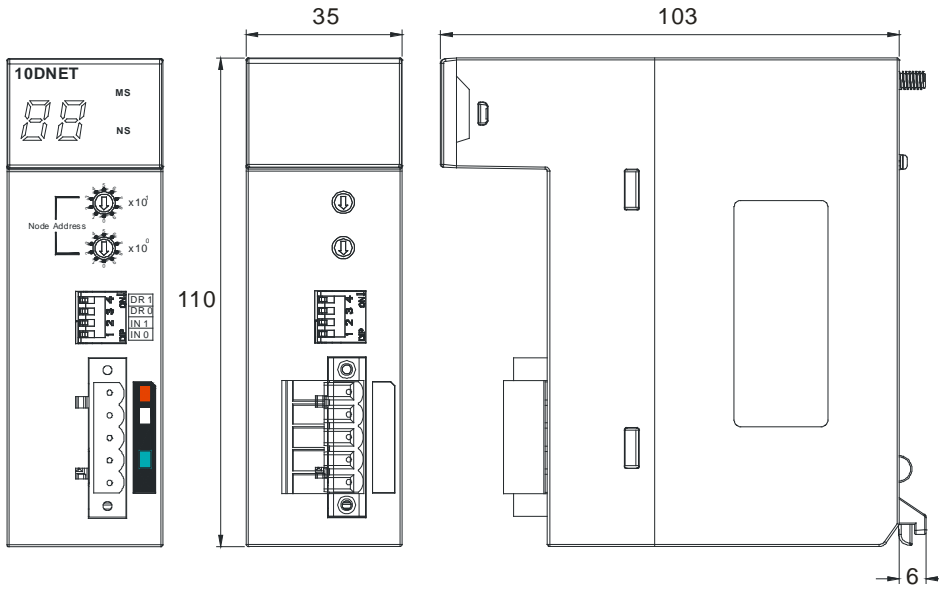

Unit: mm

● AH10PFBM-5A

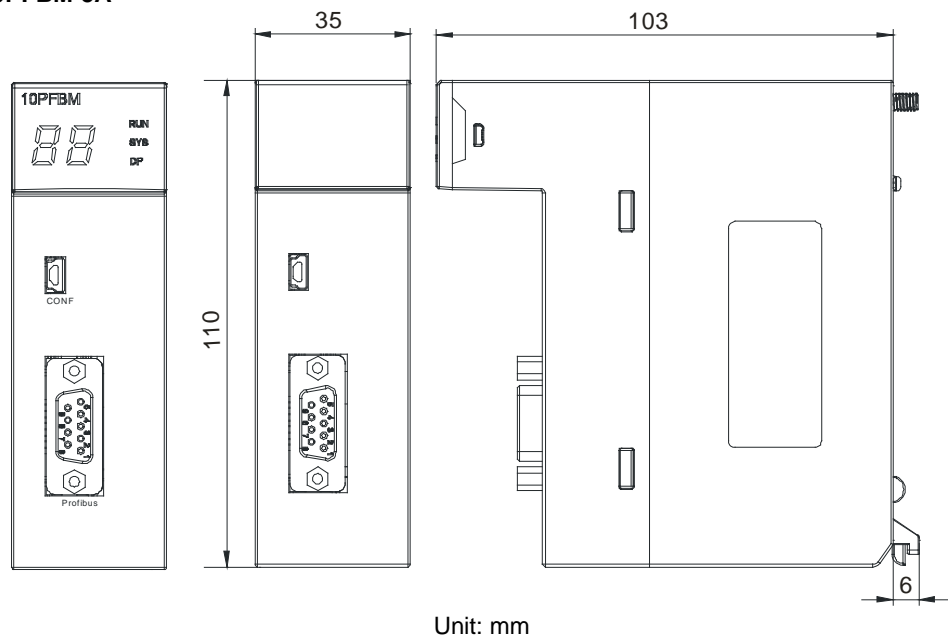

Unit: mm

● AH10PFBS-5A

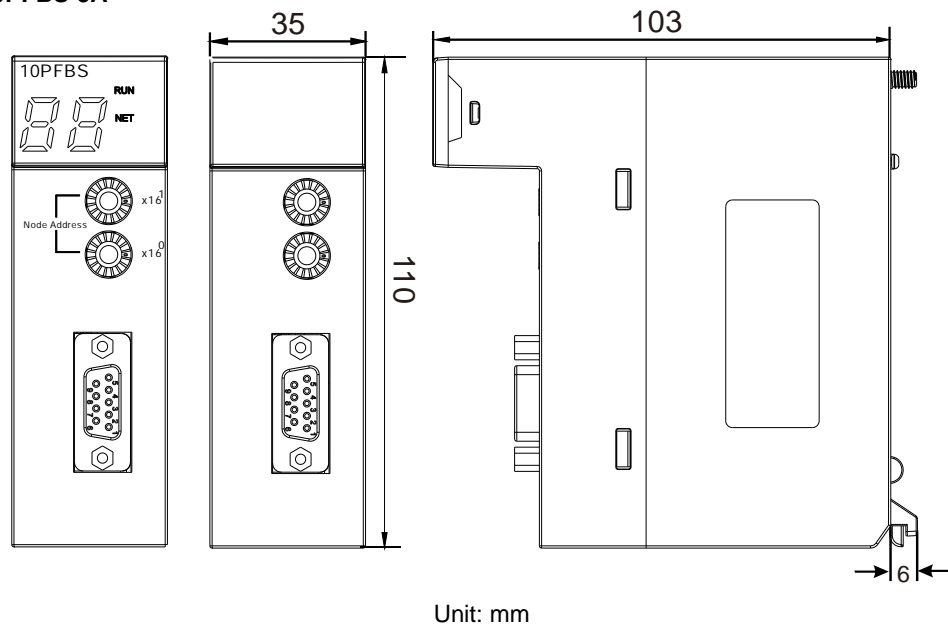

Unit: mm

2

● AH10COPM-5A

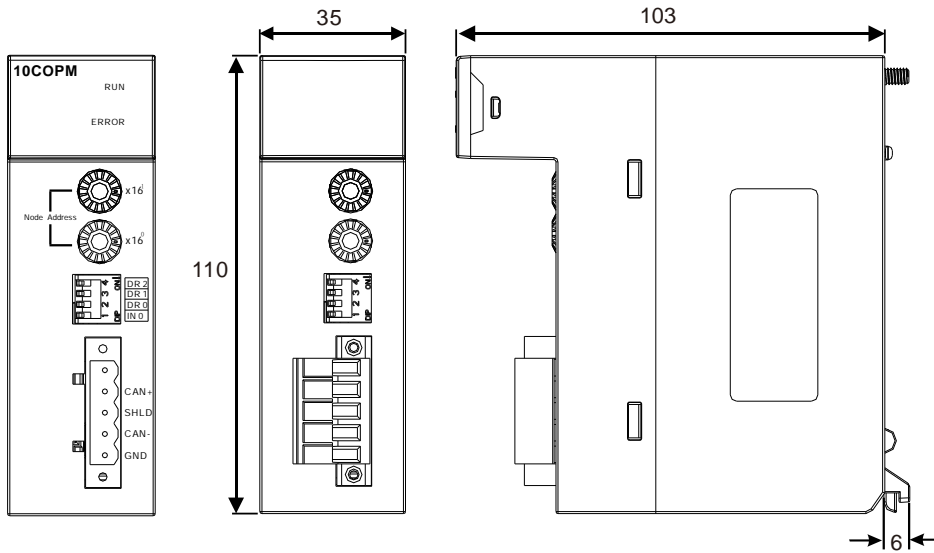

Unit: mm

2.7.4 Arrangement of Input/Output Terminals

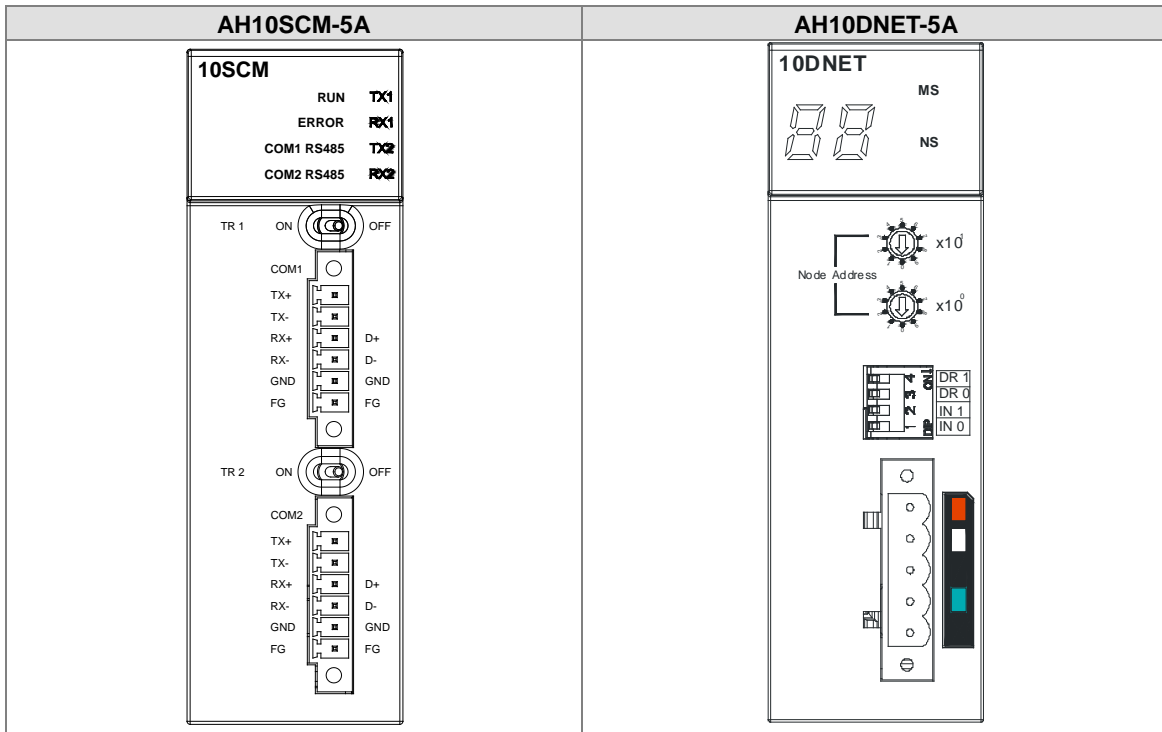

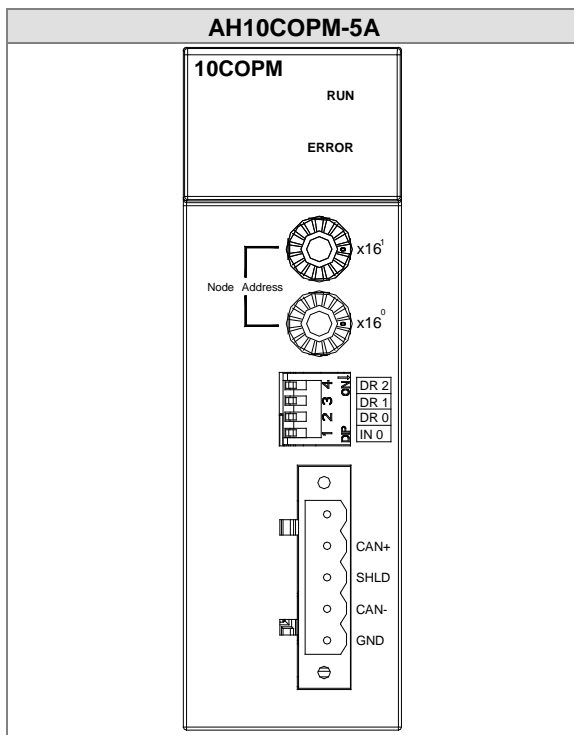

2.7.5 Setting Parameters

(1) AH10EN-5A

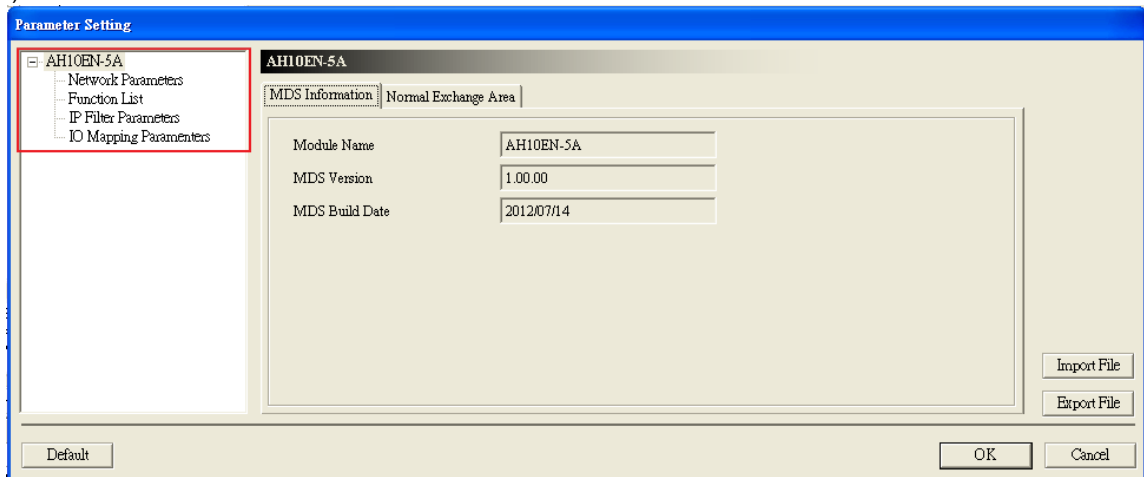

2

(2) AH10SCM-5A

Parameter Setting

AH10SCM-5A

- COM1 Setting
- COM2 Setting
- BACnet Setting

MDS Information | Normal Exchange Area

Module Name	AH10SCM-5A
MDS Version	1.00.01
MDS Build Date	2012/08/06

Default Import File Export File OK Cancel

(3) AH15SCM-5A

Parameter Setting

AH15SCM-5A

- COM1 Setting
- COM2 Setting
- BACnet Setting

MDS Information | Normal Exchange Area

Module Name	AH15SCM-5A
MDS Version	0.35.00
MDS Build Date	2016/09/22

Default Import File Export File OK Cancel

(4) AH10DNET-5A

Parameter Setting

AH10DNET-5A

- Parameters of IO mapping

MDS Information | Normal Exchange Area

Module Name	AH10DNET-5A
MDS Version	1.01.00
MDS Build Date	2013/01/22

Default Import File Export File OK Cancel

(5) AH10PFBS-5A

Parameter Setting

AH10PFBS-5A
 ↳ Conversion Flags (Read only)

AH10PFBS-5A

MDS Information Normal Exchange Area

Module Name	AH10PFBS-5A
MDS Version	1.00.01
MDS Build Date	2013/05/02

(6) AH10PFBM-5A

Parameter Setting

AH10PFBM-5A
 ↳ IO Mapping Parameters

AH10PFBM-5A

MDS Information Normal Exchange Area

Module Name	AH10PFBM-5A
MDS Version	0.30.00
MDS Build Date	2013/05/21

(7) AH10COPM-5A

Parameter Setting

AH10COPM-5A
 ↳ Mode setting and IO mapping
 ↳ Master Setting

AH10COPM-5A

MDS Information Normal Exchange Area

Module Name	AH10COPM-5A
MDS Latest Version	1.00.0
MDS Build Date	2013/12/20

Please refer to AH500 Module Manual for more information about setting parameters.

2.8 Specifications for Motion Control Modules

2.8.1 General Specifications

- AH02HC-5A

Item		Specifications
Number of channels		2 channels
Input signal	Input (differential input)	CH0: X0.8+, X0.8-, X0.9+, and X0.9- CH1: X0.10+, X0.10-, X0.11+, and X0.11-
	Pulse format	Pulse/Direction (one phase and one input) Counting up/Counting down (one phase and two inputs) One time the frequency of A/B-phase inputs (two phases and two inputs) Four times the frequency of A/B-phase inputs (two phases and two inputs)
	Signal level	5~24 V DC
Specifications	Maximum frequency of counting	The maximum frequency is 200 kHz.
	Range	The number of sampled pulses is in the range of -200000 to 200000. The number of accumulated pulses is in the range of -999999999 to 999999999. The number of input pulses is in the range of -2147483648 to 2147483648.
	Type	General count Circular count
RESET input	Input (differential input)	CH0: X0.0+ and X0.0- CH1: X0.1+ and X0.1-
	Signal level	5~24 V DC
	Maximum current	15 mA
Comparison output	Output type	Channel 0: The high-speed pulse output Y0.8 is a transistor whose collector is an open collector. Channel 1: The high-speed pulse output Y0.9 is a transistor whose collector is an open collector.
	Signal level	24 V DC
	Maximum current	15 mA
Weight		200g

● AH04HC-5A

Item		Specifications
Connector		A connector made with great precision is used. It has to be connected to an external terminal module.
Number of channels		4 channels
Input signal	Input (differential signal)	Channel 0: X0.8+, X0.8-, X0.9+, and X0.9- Channel 1: X0.10+, X0.10-, X0.11+, and X0.11- Channel 2: X0.12+, X0.12-, X0.13+, and X0.13- Channel 3: X0.14+, X0.14-, X0.15+, and X0.15-
	Pulse format	Pulse/Direction (one phase and one input) Counting up/Counting up (one phase and two inputs) One time the frequency of A/B-phase inputs (two phases and two inputs) Four times the frequency of A/B-phase inputs (two phases and two inputs)
	Signal level	5~24 V DC
Specifications	Maximum frequency of counting	The maximum frequency is 200 kHz.
	Range	The number of sampled pulses is in the range of -200000 to 200000. The number of accumulated pulses is in the range of -999999999 to 999999999. The number of input pulses is in the range of -2147483648 to 2147483648.
	Type	Linear count Circular count
RESET input	Input (differential signal)	Channel 0: X0.0+ and X0.0- Channel 1: X0.1+ and X0.1- Channel 2: X0.2+ and X0.2- Channel 3: X0.3+ and X0.3-
	Signal level	5~24 V DC
	Maximum current	15 mA
Comparison output	Output type	Channel 0: The high-speed pulse output Y0.8 is a transistor whose collector is an open collector. Channel 1: The high-speed pulse output Y0.9 is a transistor whose collector is an open collector. Channel 2: The high-speed pulse output Y0.10 is a transistor whose collector is an open collector. Channel 3: The high-speed pulse output Y0.11 is a transistor whose collector is an open collector.
	Signal level	24 V DC
	Maximum current	15 mA
Weight		200g

● AH05PM-5A

Item		Specifications		
		AH05PM-5A		
Number of axes		2 axes		
Storage		The capacity of the built-in storage is 64K steps.		
Unit		Motor unit	Compound unit	Mechanical unit
Connection with a CPU module		Users can set the initial register involved in the data exchange in a CPU module, and the number of registers involved in the data exchange in the CPU module. Four hundred data registers at most can be involved in the data exchange.		
Motor control		There are three types of pulse output modes. These modes adopt the differential output. <ol style="list-style-type: none"> 1. Pulse/Direction 2. Counting up/Counting down 3. A/B-phase output 		
Maximum speed		Single axis: 1M PPS Multi-axis interpolation: 1M PPS		
Input signal	Detector	X0.0, X0.1, X0.8, X0.9, X0.12, and X0.13		
Output signal	Servo output signal	Y0.0+, Y0.0-, Y0.2+, Y0.2-, Y0.1+, Y0.1-, Y0.3+, Y0.3-, Y0.8, and Y0.9		
External communication port		Mini USB port		
Number of basic instructions		27		
Number of applied instructions		130		
M-code		<ul style="list-style-type: none"> ● OX0~99 (motion subroutine/positioning program): M02 (The execution of the program stops. (END)) ● M00~M01, M03~M101, and M103~M65535: The execution of the program pauses. (WAIT) Users can use them freely. 		
G-code		G0 (rapid positioning), G1 (linear interpolation), G2 (circular interpolation, clockwise), G3 (circular interpolation, counterclockwise), G4 (dwell), G17 (XY plane selection), G90 (absolute programming), and G91 (incremental programming)		
Weight		200g		

2

Description of the terminals

Terminal	Description	Response characteristic	Maximum input	
			Current	Voltage
X0.0, X0.1, X0.8, X0.9, X0.12, and X0.13	<ol style="list-style-type: none"> They are single/A/B-phase input terminals. The functions of the terminals: <ul style="list-style-type: none"> ● Motion control: <ul style="list-style-type: none"> ◆ X0.0 is the PG input for axis 1, and X0.1 is the PG input for axis 2. ◆ X0.12 is the DOG input for axis 1, and X0.13 is the DOG input for axis 2. ◆ X0.8 and X0.9 are for a manual pulse generator. ● High-speed count: <ul style="list-style-type: none"> ◆ X0.0 is the RESET input for counter 0. ◆ X0.8 is the A-phase input for counter 0, and X0.9 is the B-phase input for counter 0. ● High-speed comparison and catch: The terminals can function as trigger signals for high-speed catches. ● Interrupt input terminals: X0.8, X0.9, X0.12, X0.13 	100 kHz (*1)	15 mA	24 V
Y0.8 and Y0.9	<ol style="list-style-type: none"> The high-speed pulse output terminals are transistors whose collectors are open collectors. The functions of the terminals: <ul style="list-style-type: none"> ● Motion control: Y0.8 is the CLEAR output for axis 1, and Y0.9 is the CLEAR output for axis 2. ● High-speed comparison and catch: The high-speed comparison output terminals provide the PWM function. 	200 kHz	15 mA	24 V
Y0.0+, Y0.0-, Y0.1+, Y0.1-, Y0.2+, Y0.2-, Y0.3+, and Y0.3-	<ol style="list-style-type: none"> They are differential output terminals. The function of the terminals: <ul style="list-style-type: none"> ● Motion control: <ul style="list-style-type: none"> ◆ Y0.0+ and Y0.0- are the A-phase output terminals for axis 1. Y0.2+ and Y0.2- are the A-phase output terminals for axis 2. ◆ Y0.1+ and Y0.1- are the B-phase output terminals for axis 1. Y0.3+ and Y0.3- are the B-phase output terminals for axis 2. 	1 MHz	5 mA	5 V

*1. If the frequency of input signals received by an input terminal must be 200 kHz, the input terminal must be connected to a 1 kΩ (2 W) resistor in parallel.

● AH10PM-5A

Item		Specifications		
		AH10PM-5A		
Number of axes		6 axes		
Storage		The capacity of the built-in storage is 64K steps.		
Unit		Motor unit	Compound unit	Mechanical unit
Connection with a CPU module		Users can set the initial register involved in the data exchange in a CPU module, and the number of registers involved in the data exchange in the CPU module. Four hundred data registers at most can be involved in the data exchange.		
Motor control		There are three types of pulse output modes. These modes adopt the differential output. 1. Pulse/Direction 2. Counting up/Counting down 3. A/B-phase output		
Maximum speed		Single axis: 1M PPS Multi-axis interpolation: 1M PPS		
Input signal	Operating switch	STOP/RUN (automatic/manual switch)		
	Detector	X0.8, X0.9, X0.10, X0.11, X0.12, X0.13, X0.14, X0.15, X0.0+, X0.0-, X0.1+, X0.1-, X0.2+, X0.2-, X0.3+, and X0.3-		
Output signal	Servo output signal	Y0.0+, Y0.0-, Y0.2+, Y0.2-, Y0.4+, Y0.4-, Y0.6+, Y0.6-, Y0.1+, Y0.1-, Y0.3+, Y0.3-, Y0.5+, Y0.5-, Y0.7+, Y0.7-, Y0.8, Y0.9, Y0.10, and Y0.11		
External communication port		Mini USB port Ethernet port		
Expansion storage device		Mini SD card The maximum capacity is 32 GB.		
Number of basic instructions		27		
Number of applied instructions		130		
M-code		<ul style="list-style-type: none"> ● OX0~99 (motion subroutine/positioning program): M02 (The execution of the program stops. (END)) ● M00~M01, M03~M101, and M103~M65535: The execution of the program pauses. (WAIT) Users can use them freely. 		
G-code		G0 (rapid positioning), G1 (linear interpolation), G2 (circular interpolation, clockwise), G3 (circular interpolation, counterclockwise), G4 (dwell), G17 (XY plane selection), G18 (ZX plane selection), G19 (YZ plane selection), G90 (absolute programming), and G91 (incremental programming)		
Weight		220g		

Description of the terminals

Terminal	Description	Response characteristic	Maximum input	
			Current	Voltage
X0.0+, X0.0-, X0.1+, X0.1-, X0.2+, X0.2-, X0.3+, and X0.3-	<ol style="list-style-type: none"> They are differential input terminals. The functions of the terminals: <ul style="list-style-type: none"> ● Motion control: They are the PG input terminals for axis 1~axis 4. ● High-speed counter: X0.0+ and X0.0- are the RESET input terminals for counter 0. X0.1+ and X0.1- are the RESET input terminals for counter 1. X0.2+ and X0.2- are the RESET input terminals for counter 2 and counter 4. X0.3+ and X0.3- are the RESET input terminals for counter 3 and counter 5. ● High-speed comparison and catch: The terminals can function as trigger signals for high-speed catches. 	200 kHz	15 mA	5~24 V
X0.8 and X0.9	<ol style="list-style-type: none"> They are single/A/B-phase input terminals. The functions of the terminals: <ul style="list-style-type: none"> ● Motion control: The terminals are for a manual pulse generator. ● High-speed count: <ul style="list-style-type: none"> ◆ The terminals are for counter 0. ◆ X0.8 is the A-phase input for counter 0, and X0.9 is the B-phase input for counter 0. ● High-speed comparison and catch: The terminals can function as trigger signals for high-speed catches. ● Interrupt input terminals 	100 kHz (*1)	15 mA	24 V
X0.10, X0.11, X0.12, X0.13, X0.14, and X0.15	<ol style="list-style-type: none"> They are single/A/B-phase input terminals. The functions of the terminals: <ul style="list-style-type: none"> ● Motion control: They are the DOG input terminals for axis 1~axis 6. ● High-speed counter: <ul style="list-style-type: none"> ◆ The terminals are for counter 1~counter 5. ◆ X0.10 is the A-phase input for counter 1, X0.12 is the A-phase input for counter 2 and counter 4, and X0.14 is the A-phase input for counter 3 and counter 5. ◆ X0.11 is the B-phase input for counter 1, X0.13 is the B-phase input for counter 2 and counter 4, and X0.15 is the B-phase input for counter 3 and counter 5. ● High-speed comparison and catch: The terminals can function as trigger signals for high-speed catches. ● Interrupt input terminals 	100 kHz (*1)	15 mA	24 V
Y0.8, Y0.9, Y0.10, and Y0.11	<ol style="list-style-type: none"> The high-speed pulse output terminals are transistors whose collectors are open collectors. The functions of the terminals: <ul style="list-style-type: none"> ● Motion control: <ul style="list-style-type: none"> ◆ The terminals are the CLEAR output terminals for axis 1~axis 4, and provide the PWM function. 	200 kHz	15 mA	24 V

2

Terminal	Description	Response characteristic	Maximum input	
			Current	Voltage
	<ul style="list-style-type: none"> ◆ Y0.8 and Y0.9 are for axis 5. Y0.10 and Y0.11 are for axis 6. Y0.8 is the A-phase output for axis 5, and Y0.10 is the A-phase output for axis 6. Y0.9 is the B-phase output for axis 5, and Y0.11 is the B-phase output for axis 6. ● High-speed comparison and catch: The terminals can function as high-speed comparison output terminals. 			
Y0.0+, Y0.0-, Y0.1+, Y0.1-, Y0.2+, Y0.2-, Y0.3+, Y0.3-, Y0.4+, Y0.4-, Y0.5+, Y0.5-, Y0.6+, Y0.6-, Y0.7+, and Y0.7-	<ol style="list-style-type: none"> 1. They are differential output terminals. 2. The function of the terminals: <ul style="list-style-type: none"> ● Motion control: <ul style="list-style-type: none"> ◆ The terminals are for axis 1~axis 4. ◆ Y0.0+ and Y0.0- are the A-phase output terminals for axis 1. Y0.2+ and Y0.2- are the A-phase output terminals for axis 2. Y0.4+ and Y0.4- are the A-phase output terminals for axis 3. Y0.6+ and Y0.6- are the A-phase output terminals for axis 4. ◆ Y0.1+ and Y0.1- are the B-phase output terminals for axis 1. Y0.3+ and Y0.3- are the B-phase output terminals for axis 2. Y0.5+ and Y0.5- are the B-phase output terminals for axis 3. Y0.7+ and Y0.7- are the B-phase output terminals for axis 4. ◆ Y0.0+ and Y0.0- are the CLEAR output terminals for axis 5. Y0.1+ and Y0.1- are the CLEAR output terminals for axis 6. 	1 MHz	5 mA	5 V

*1. If the frequency of input signals received by an input terminal must be 200 kHz, the input terminal must be connected to a 1 kΩ (2 W) resistor in parallel.

● AH15PM-5A

Item		AH15PM-5A		
Number of actual axes		4 axes		
Storage		The capacity of the built-in storage is 64K steps.		
Unit		Motor unit	Compound unit	Mechanical unit
Connection with a CPU module		Users can set the initial register involved in the data exchange in a CPU module, and the number of registers involved in the data exchange in the CPU module. Four hundred data registers at most can be involved in the data exchange.		
Motor control		There are three types of pulse output modes. These modes adopt the differential output. <ol style="list-style-type: none"> 1. Pulse/Direction 2. Counting up/Counting down 3. A/B-phase output 		
Maximum speed		Single axis: 1M PPS Multi-axis interpolation: 1M PPS		
Input signal	Operating switch	STOP/RUN (automatic/manual switch)		
	Detector	X0.0+, X0.0-, X0.1+, X0.1-, X0.2+, X0.2-, X0.3+, X0.3-, X0.4, X0.5, X0.6, X0.7, X0.10, X0.11, X0.12, X0.13, X0.14, X0.15, X1.0, X1.1, X1.2, X1.3, X1.4, and X1.5		
Output signal	Servo output signal	Y0.0+, Y0.0-, Y0.2+, Y0.2-, Y0.4+, Y0.4-, Y0.6+, Y0.6-, Y0.1+, Y0.1-, Y0.3+, Y0.3-, Y0.5+, Y0.5-, Y0.7+, Y0.7-, Y0.8, Y0.9, Y0.10, and Y0.11		

Item	AH15PM-5A
External communication port	Mini USB port Ethernet port
Expansion storage device	Mini SD card The maximum capacity is 32 GB.
Number of basic instructions	27
Number of applied instructions	130
M-code	1. OX0~OX99 (motion subroutine/positioning program): M02 (The execution of the program stops. (END)) 2. M00~M01, M03~M101, and M103~M65535: The execution of the program pauses. (WAIT) Users can use them freely.
G-code	G0 (rapid positioning), G1 (linear interpolation), G2 (circular interpolation, clockwise), G3 (circular interpolation, counterclockwise), G4 (dwell), G17 (XY plane selection), G18 (ZX plane selection), G19 (YZ plane selection), G90 (absolute programming), and G91 (incremental programming)
Weight	220g

Description of the terminals

Terminal	Description	Response characteristic	Maximum input	
			Current	Voltage
X0.0+, X0.0-, X0.1+, X0.1-, X0.2+, X0.2-, X0.3+, and X0.3-	1. They are differential input terminals. 2. The functions of the terminals: <ul style="list-style-type: none"> ● Motion control: They are the PG input terminals for axis 1~axis 4. ● High-speed counter: X0.0+ and X0.0- are the RESET input terminals for counter 0. X0.1+ and X0.1- are the RESET input terminals for counter 1. X0.2+ and X0.2- are the RESET input terminals for counter 2 and counter 4. X0.3+ and X0.3- are the RESET input terminals for counter 3 and counter 5. ● High-speed comparison and catch: The terminals can function as trigger signals for high-speed catches. ● Interrupt input terminals 	200 kHz	15 mA	5~24 V
X0.4, X0.5, X0.6, and X0.7	1. They are single/A/B-phase input terminals. 2. The functions of the terminals: <ul style="list-style-type: none"> ● Motion control: They are the DOG input terminals for axis 1~axis 4. 	100 kHz (*1)	15 mA	24 V
X0.8+, X0.8-, X0.9+, and X0.9-	1. They are differential input terminals. 2. The functions of the terminals: <ul style="list-style-type: none"> ● Motion control: The terminals are for a manual pulse generator. ● High-speed count: <ul style="list-style-type: none"> ◆ The terminals are for counter 0. ◆ X0.8+ and X0.8- are the A-phase input terminals for counter 0, and X0.9+ and X0.9- are the B-phase input terminals for counter 0. ● High-speed comparison and catch: The terminals can function as trigger signals for high-speed catches. ● Interrupt input terminals 	200 kHz	15 mA	5~24 V

2

Terminal	Description	Response characteristic	Maximum input	
			Current	Voltage
X0.10, X0.11, X0.12, X0.13, X0.14, X0.15, X1.0, and X1.1	<ol style="list-style-type: none"> They are differential input terminals. The functions of the terminals: <ul style="list-style-type: none"> ● Motion control: X0.10 is LSP0, X0.11 is LSN0, X0.12 is LSP1, X0.13 is LSN1, X0.14 is LSP2, X0.15 is LSN2, X1.0 is LSP3, and X1.1 is LSN3. ● High-speed count: <ul style="list-style-type: none"> ◆ The terminals are for counter 1~counter 5. ◆ X0.10 is the A-phase input for counter 1. X0.12 is the A-phase input for counter 2 and counter 4. X0.14 is the A-phase input for counter 3 and counter 5. ◆ X0.11 is the B-phase input for counter 1. X0.13 is the B-phase input for counter 2 and counter 4. X0.15 is the B-phase input for counter 3 and counter 5. ● High-speed comparison and catch: The terminals can function as trigger signals for high-speed catches. ● Interrupt input terminals: X0.10~X0.15 	100 kHz (*1)	15 mA	24 V
X1.2, X1.3, X1.4, and X1.5	<ol style="list-style-type: none"> They are single/A/B-phase input terminals. 	100 kHz (*1)	15 mA	24 V
Y0.8, Y0.9, Y0.10, and Y0.11	<ol style="list-style-type: none"> The high-speed pulse output terminals are transistors whose collectors are open collector. The function of the terminals: <ul style="list-style-type: none"> ● Motion control: The terminals are the CLEAR output terminals for axis 1~axis 4. ● High-speed comparison and catch: The terminals can function as high-speed comparison output terminals. 	200 kHz	15 mA	24 V
Y0.0+, Y0.0-, Y0.1+, Y0.1-, Y0.2+, Y0.2-, Y0.3+, Y0.3-, Y0.4+, Y0.4-, Y0.5+, Y0.5-, Y0.6+, Y0.6-, Y0.7+, and Y0.7-	<ol style="list-style-type: none"> They are differential output terminals. The function of the terminals: <ul style="list-style-type: none"> ● Motion control: <ul style="list-style-type: none"> ◆ The terminals are for axis 1~axis 4. ◆ Y0.0+ and Y0.0- are the A-phase output terminals for axis 1. Y0.2+ and Y0.2- are the A-phase the output terminals for axis 2. Y0.4+ and Y0.4- are the A-phase output terminals for axis 3. Y0.6+ and Y0.6- are the A-phase output terminals for axis 4. ◆ Y0.1+ and Y0.1- are the B-phase output terminals for axis 1. Y0.3+ and Y0.3- are the B-phase output terminals for axis 2. Y0.5+ and Y0.5- are the B-phase output terminals for axis 3. Y0.7+ and Y0.7- are the B-phase output terminals for axis 4. ◆ Y0.0+ and Y0.0- are the CLEAR output terminals for axis 5. Y0.1+ and Y0.1- are the CLEAR output terminals 	1 MHz	5 mA	5 V

Terminal	Description	Response characteristic	Maximum input	
			Current	Voltage
	for axis 6.			

*1. If the frequency of input signals received by an input terminal must be 200 kHz, the input terminal must be connected to a 1 kΩ (2 W) resistor in parallel.

● AH20MC-5A

Item		Specifications		
		AH20MC-5A		
Number of axes		12 axes		
Storage		The capacity of the built-in storage is 64K steps.		
Unit		Motor unit	Compound unit	Mechanical unit
Connection with a CPU module		Users can set the initial register involved in the data exchange in a CPU module, and the number of registers involved in the data exchange in the CPU module. Four hundred data registers at most can be involved in the data exchange.		
Motor control		Delta high-speed motion control system DMCNET (Delta Motion Control Network) The response time is one millisecond.		
Maximum speed		Single axis: 1M PPS Two-axis interpolation: 1M PPS		
Input signal	Operating switch	STOP/RUN (automatic/manual switch)		
	Detector	X0.10+, X0.10-, X0.11+, X0.11-, X0.12+, X0.12-, X0.13+, X0.13-, X0.14+, X0.14-, X0.15+, X0.15-, X0.0+, X0.0-, X0.1+, X0.1-, X0.2+, X0.2-, X0.3+, and X0.3-, X0.8+, X0.8-, X0.9+, X0.9-		
Output signal	Servo output signal	Y0.8, Y0.9, Y0.10, Y0.11		
External communication port		Mini USB port Ethernet port DMCNET port		
Expansion storage device		Mini SD card The maximum capacity is 32 GB.		
Number of basic instructions		27		
Number of applied instructions		130		
M-code		<ul style="list-style-type: none"> ● OX0~99 (motion subroutine/positioning program): M02 (The execution of the program stops. (END)) ● M00~M01, M03~M101, and M103~M65535: The execution of the program pauses. (WAIT) Users can use them freely. 		
G-code		G0 (rapid positioning), G1 (linear interpolation), G2 (circular interpolation, clockwise), G3 (circular interpolation, counterclockwise), G4 (dwell), G17 (XY plane selection), G18 (ZX plane selection), G19 (YZ plane selection), G90 (absolute programming), and G91 (incremental programming)		
Weight		220g		

Description of the terminals

Terminal	Description	Response characteristic	Maximum input	
			Current	Voltage
X0.0+, X0.0-, X0.1+, X0.1-, X0.2+, X0.2-, X0.3+, and X0.3-	<ol style="list-style-type: none"> They are differential input terminals. The functions of the terminals: <ul style="list-style-type: none"> High-speed count: <ul style="list-style-type: none"> The terminals are the RESET input terminals for counter 0~counter 5. X0.0+ and X0.0- are for counter 0. X0.1+ and X0.1- are for counter 1. X0.2+ and X0.2- are for counter 2 and counter 4. X0.3+ and X0.3- are for counter 3 and counter 5. High-speed comparison and catch: The terminals can function as trigger signals for high-speed catches. 	200 kHz	15 mA	5~24 V
X0.8+, X0.8-, X0.9+, and X0.9-	<ol style="list-style-type: none"> They are differential input terminals. The functions of the terminals: <ul style="list-style-type: none"> Motion control: The terminals are for a manual pulse generator. High-speed count: <ul style="list-style-type: none"> The terminals are for counter 0. X0.8+ and X0.8- are the A-phase input terminals for counter 0. X0.9+ and X0.9- are the B-phase input terminals for counter 0. High-speed comparison and catch: The terminals can function as trigger signals for high-speed catches. Interrupt input terminals 	200 kHz	15 mA	5~24 V
X0.10+, X0.10-, X0.11+, X0.11-, X0.12+, X0.12-, X0.13+, X0.13-, X0.14+, X0.14-, X0.15+, and X0.15-	<ol style="list-style-type: none"> They are differential input terminals. The functions of the terminals: <ul style="list-style-type: none"> Motion control: Dog inputs are for Axis1~Axis 6 and for the motion of the single-axis inputting. High-speed count: <ul style="list-style-type: none"> The terminals are for counter 1~counter 5. X0.10+ and X0.10- are the A-phase input terminals for counter 1. X0.12+ and X0.12- are the A-phase input terminals for counter 2 and counter 4. X0.14+ and X0.14- are the A-phase input terminals for counter 3 and counter 5. X0.11+ and X0.11- are the B-phase input terminals for counter 1. X0.13+ and X0.13- are the B-phase input terminals for counter 2 and counter 4. X0.15+ and X0.15- are the B-phase input terminals for counter 3 and counter 5. High-speed comparison and catch: The terminals can function as trigger signals for high-speed catches. Interrupt input terminals 	200 kHz	15 mA	5~24 V

Terminal	Description	Response characteristic	Maximum input	
			Current	Voltage
Y0.8, Y0.9, Y0.10, and Y0.11	1. The high-speed pulse output terminals are transistors whose collectors are open collectors. 2. The function of the terminals: <ul style="list-style-type: none"> ● High-speed comparison and catch: The terminals can function as high-speed comparison output terminals. 	200 kHz	15 mA	24 V

2.8.2 Profiles

● AH02HC-5A

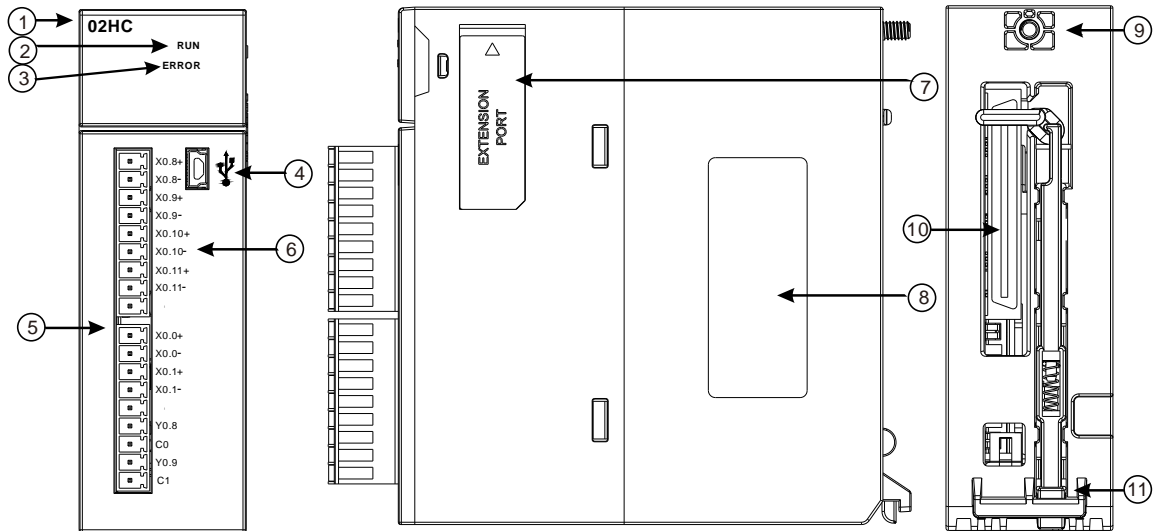

Number	Name	Description
1	Model name	Model name of the module
2	RUN LED indicator (green)	Operating status of the module ON: The module is running. OFF: The module stops running.
3	ERROR LED indicator (red)	Error status of the module Blinking: The module is abnormal.
4	USB port	Providing the mini USB communication interface
5	Terminals	Input/Output terminals
6	Arrangement of the input/output terminals	Arrangement of the terminals
7	Extension port	Updating the firmware
8	Label	Nameplate
9	Set screw	Fixing the module
10	Connector	Connecting the module and a backplane
11	Projection	Fixing the module

2

● AH04HC-5A

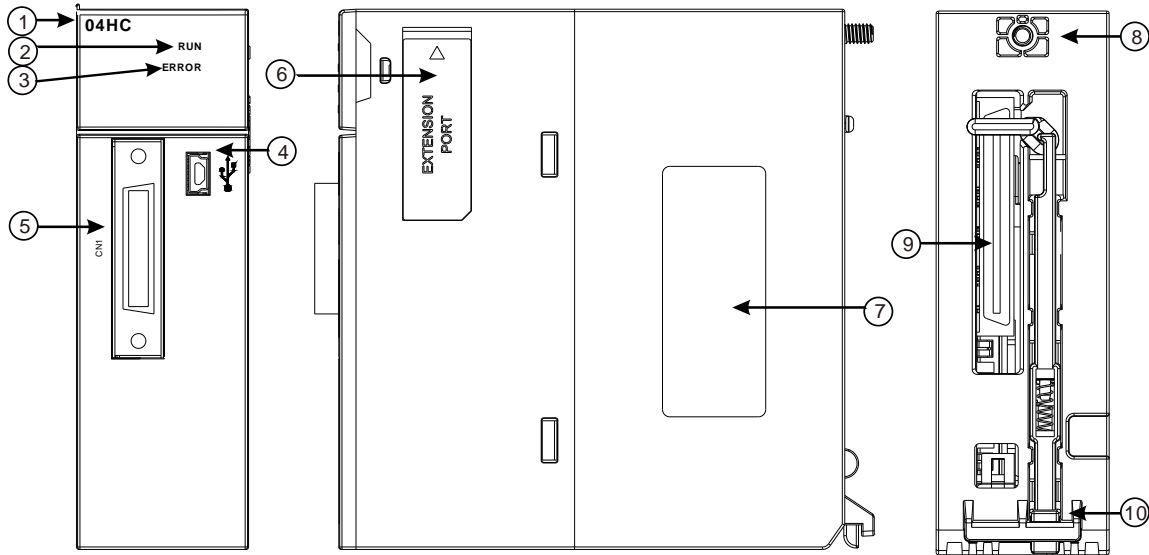

Number	Name	Description
1	Model name	Model name of the module
2	RUN LED indicator (green)	Operating status of the module ON: The module is running. OFF: The module stops running.
3	ERROR LED indicator (red)	Error status of the module Blinking: The module is abnormal.
4	USB port	Providing the mini USB communication interface
5	Connector	Connecting the module and an I/O extension cable
6	Extension port	Updating the firmware
7	Label	Nameplate
8	Set screw	Fixing the module
9	Connector	Connecting the module and a backplane
10	Projection	Fixing the module

● AH05PM-5A

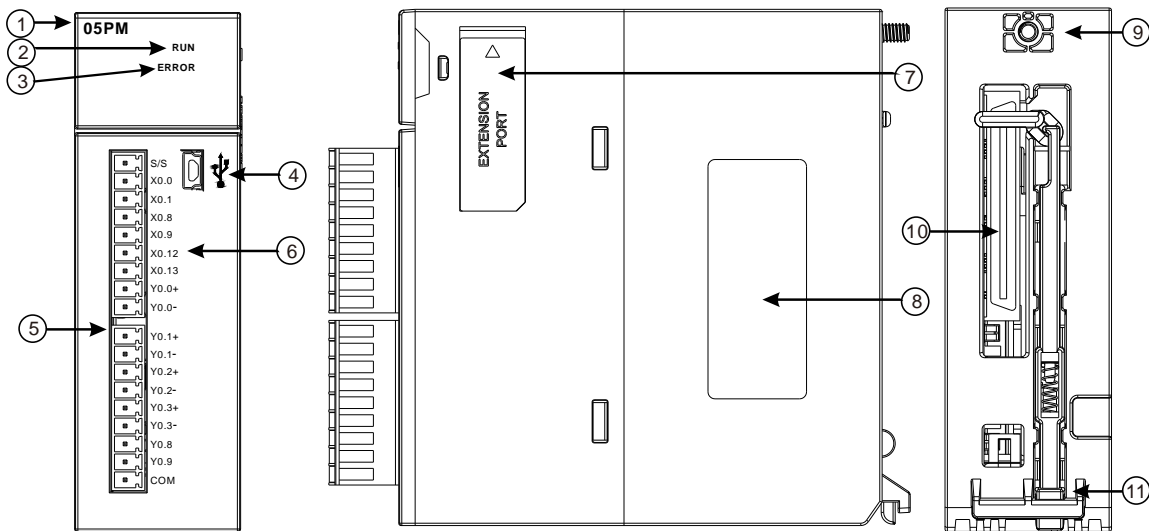

Number	Name	Description
1	Model name	Model name of the module
2	RUN LED indicator (green)	Operating status of the module ON: The module is running. OFF: The module stops running.
3	ERROR LED indicator (red)	Error status of the module Blinking: The module is abnormal.
4	USB port	Providing the mini USB communication interface
5	Terminals	Input/Output terminals
6	Arrangement of the input/output terminals	Arrangement of the terminals
7	Extension port	Updating the firmware
8	Label	Nameplate
9	Set screw	Fixing the module
10	Connector	Connecting the module and a backplane
11	Projection	Fixing the module

● AH10PM-5A

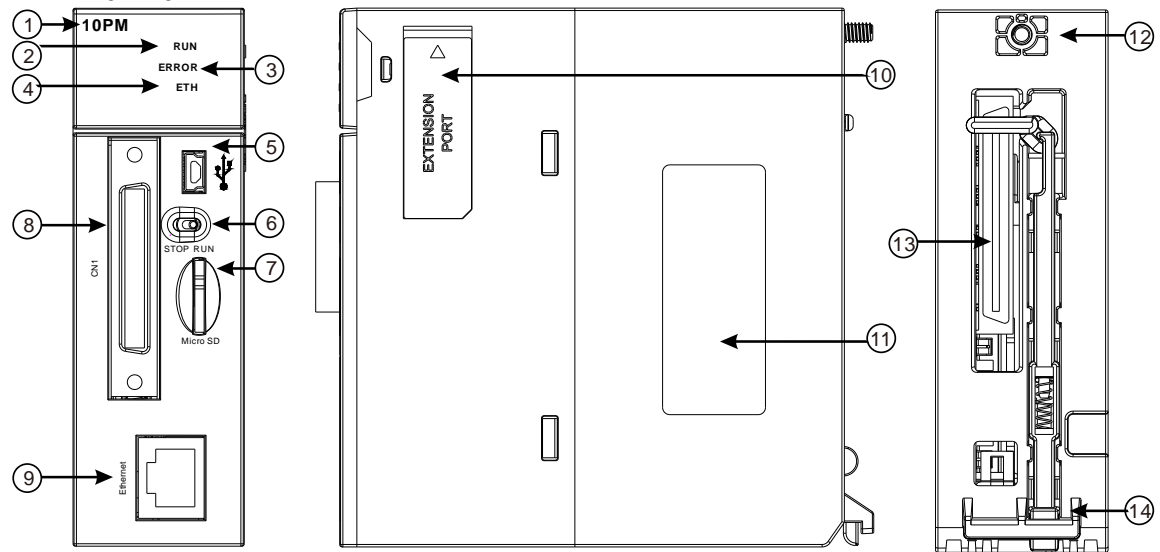

Number	Name	Description
1	Model name	Model name of the module
2	RUN LED indicator (green)	Operating status of the module ON: The module is running. OFF: The module stops running.
3	ERROR LED indicator (red)	Error status of the module Blinking: The module is abnormal.
4	Ethernet connection LED indicator (green)	Status of the Ethernet connection ON: The Ethernet connection is being connected. OFF: The Ethernet connection is disconnected.
5	USB port	Providing the mini USB communication interface
6	RUN/STOP switch	RUN: The user program is executed. STOP: The execution of the user program stops.
7	SD slot	Providing the SD interface
8	Connector	Connecting the module and an I/O extension cable
9	Ethernet port	Providing the Ethernet communication interface
10	Extension port	Updating the firmware
11	Label	Nameplate
12	Set screw	Fixing the module

Number	Name	Description
13	Connector	Connecting the module and a backplane
14	Projection	Fixing the module

2

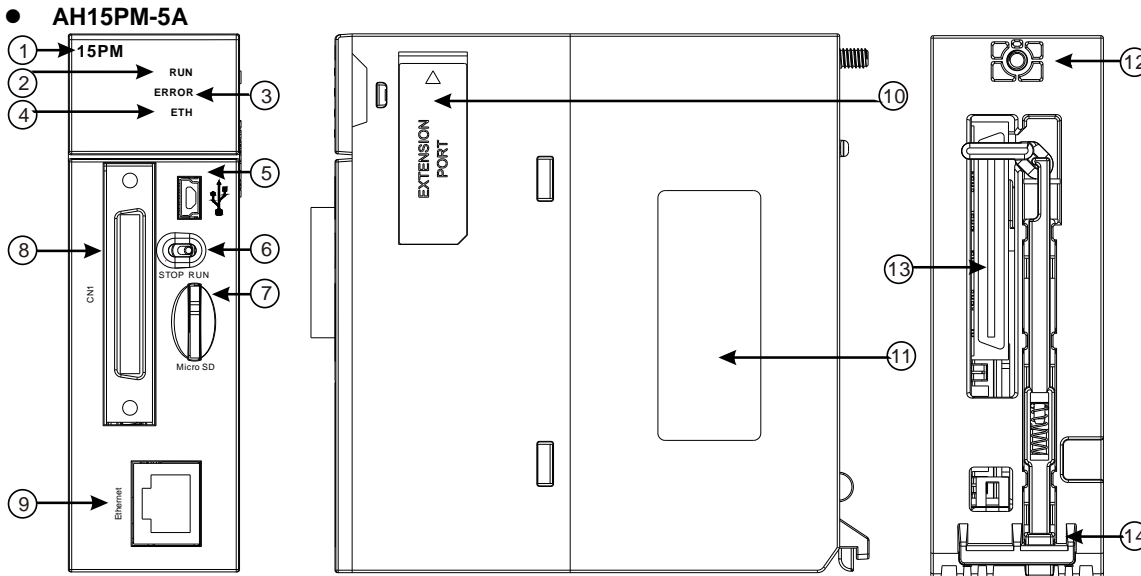

Number	Name	Description
1	Model name	Model name of the module
2	RUN LED indicator (green)	Operating status of the module ON: The module is running. OFF: The module stops running.
3	ERROR LED indicator (red)	Error status of the module Blinking: The module is abnormal.
4	Ethernet connection LED indicator (green)	Status of the Ethernet connection ON: The Ethernet connection is being connected. OFF: The Ethernet connection is disconnected.
5	USB port	Providing the mini USB communication interface
6	RUN/STOP switch	RUN: The user program is executed. STOP: The execution of the user program stops.
7	SD slot	Providing the SD interface
8	Connector	Connecting the module and an I/O extension cable
9	Ethernet port	Providing the Ethernet communication interface
10	Extension port	Updating the firmware
11	Label	Nameplate
12	Set screw	Fixing the module
13	Connector	Connecting the module and a backplane
14	Projection	Fixing the module

● AH20MC-5A

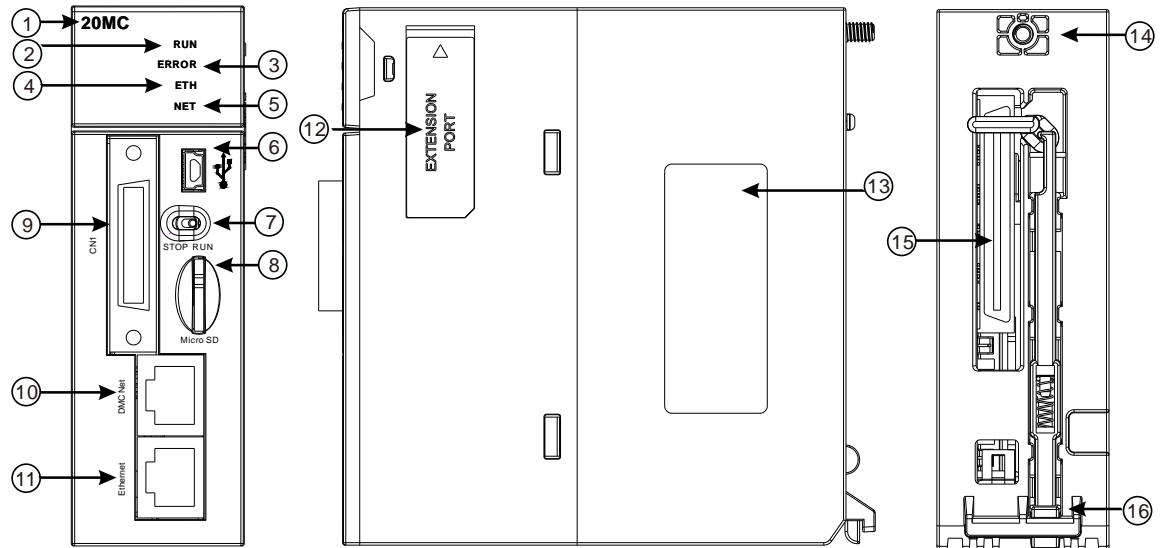

2

Number	Name	Description
1	Model name	Model name of the module
2	RUN LED indicator (green)	Operating status of the module ON: The module is running. OFF: The module stops running.
3	ERROR LED indicator (red)	Error status of the module Blinking: The module is abnormal.
4	Ethernet connection LED indicator (green)	Status of the Ethernet connection ON: The Ethernet connection is being connected. OFF: The Ethernet connection is disconnected.
5	DMCNET connection LED indicator (green)	Status of the DMCNET connection ON: The DMCNET connection is being connected. OFF: The DMCNET connection is disconnected.
6	USB port	Providing the mini USB communication interface
7	RUN/STOP switch	RUN: The user program is executed. STOP: The execution of the user program stops.
8	SD slot	Providing the SD interface
9	Connector	Connecting the module and an I/O extension cable.
10	DMCNET port	Providing the DMCNET communication interface
11	Ethernet port	Providing the Ethernet communication interface
12	Extension port	For updating the firmware
13	Label	Nameplate
14	Set screw	Fixing the module
15	Connector	Connecting the module and a backplane
16	Projection	Fixing the module

● I/O extension cable, and external terminal module

1. I/O extension cable UC-ET010-13B/UC-ET010-15B

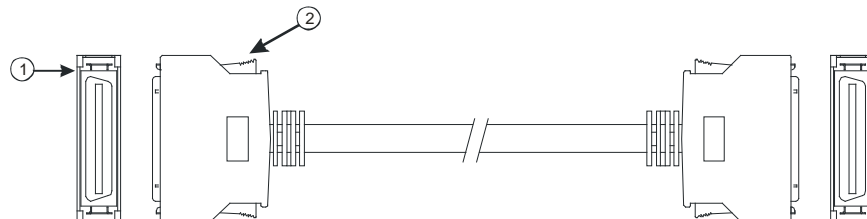

2

Number	Name	Description
1	Connector	Connecting a motion control module and an external terminal module UC-ET010-13B is a 36-pin I/O extension cable for AH04HC-5A and AH20MC-5A. UC-ET010-15B is a 50-pin I/O extension cable for AH10PM-5A and AH15PM-5A.
2	Clip	Fixing the connector

2. External terminal module for AH04HC-5A and AH20MC-5A: UB-10-IO16C

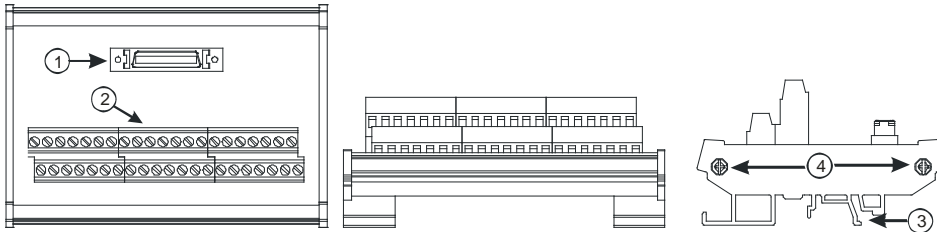

3. External terminal module for AH10PM-5A: UB-10-IO24CC

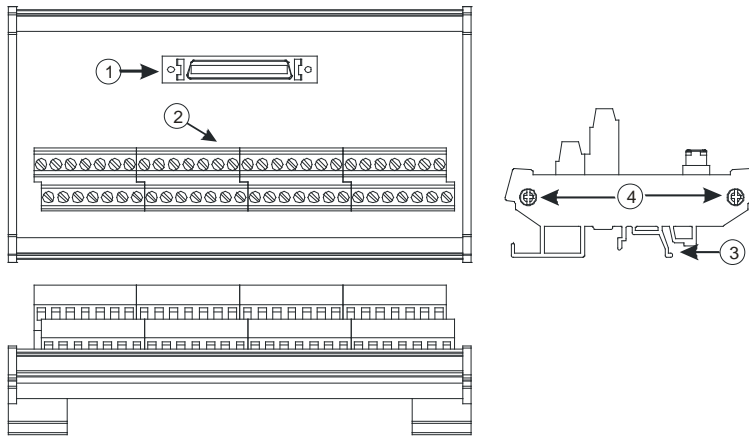

4. External terminal module for AH15PM-5A: UB-10-IO34CC

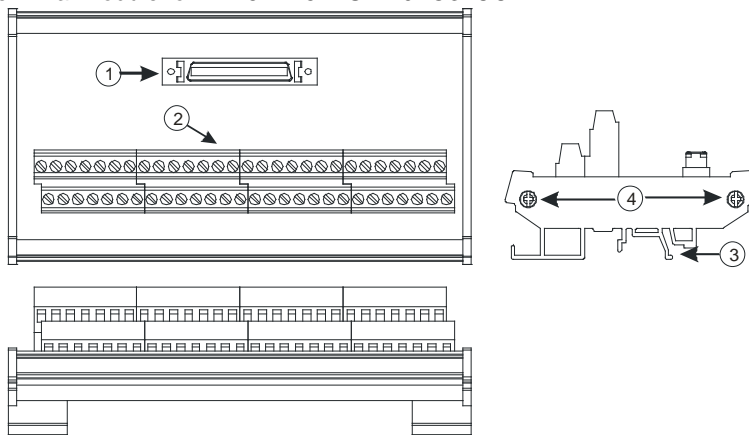

Number	Name	Description
1	Connector	Connecting the external terminal module and a motion control module
2	Terminals	Input/Output terminals for wiring
3	Clip	Hanging the external terminal module on a DIN rail
4	Set screw	Fixing the base

2.8.3 Dimensions

- AH02HC-5A

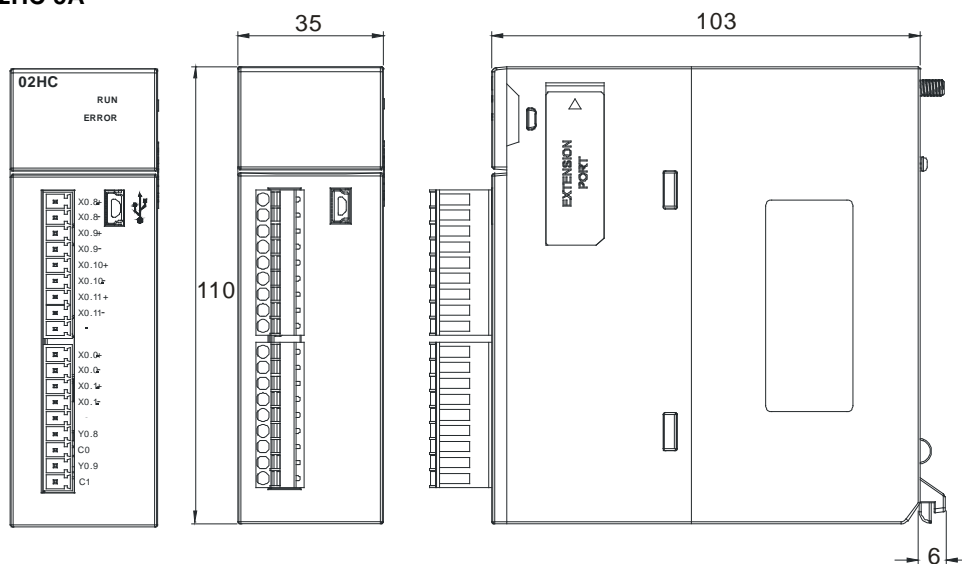

Unit: mm

- AH04HC-5A

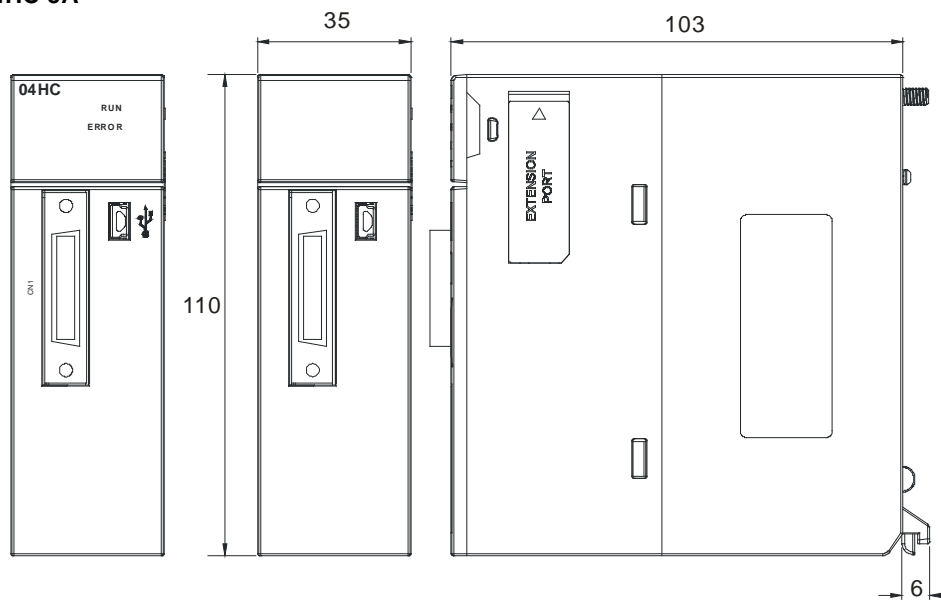

Unit: mm

2

2

● AH05PM-5A

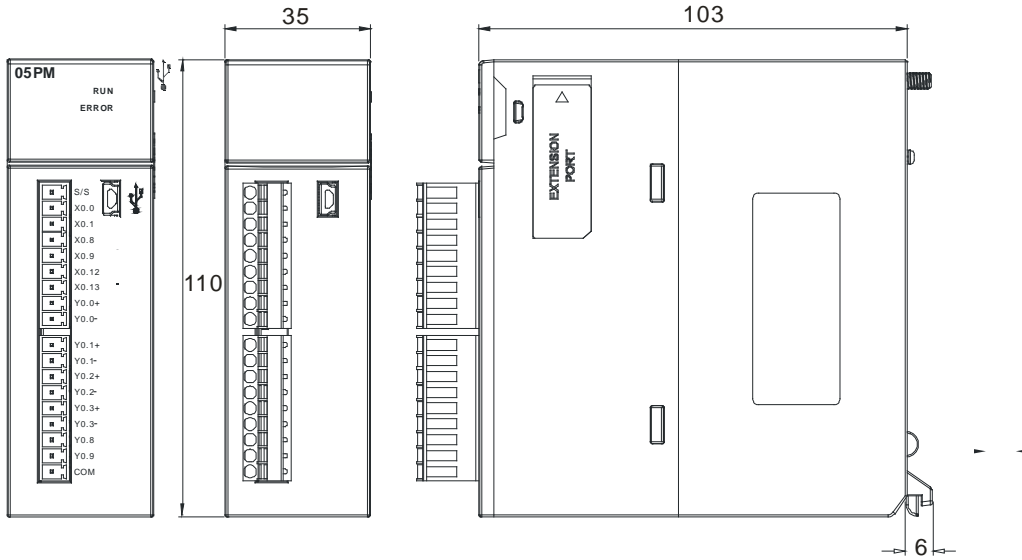

Unit: mm

● AH10PM-5A

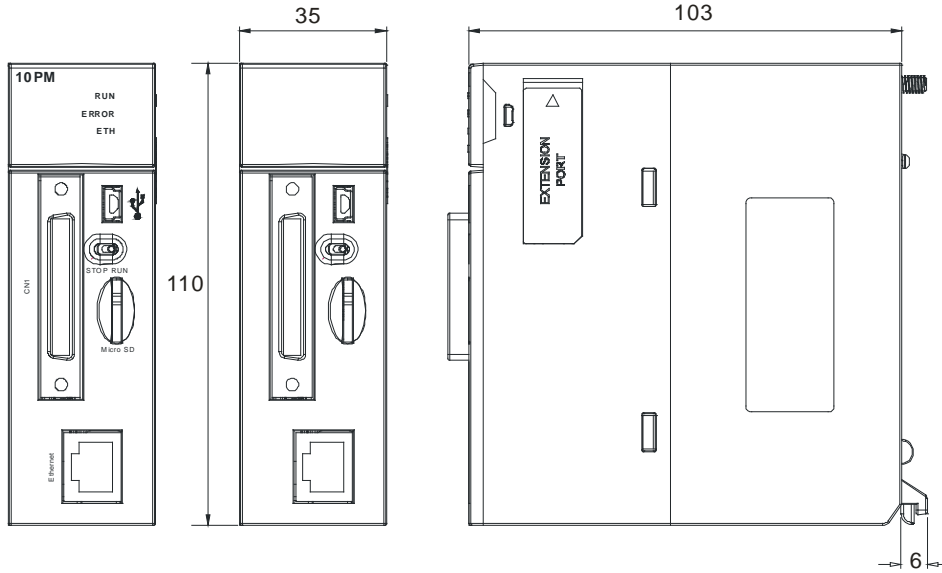

Unit: mm

● AH15PM-5A

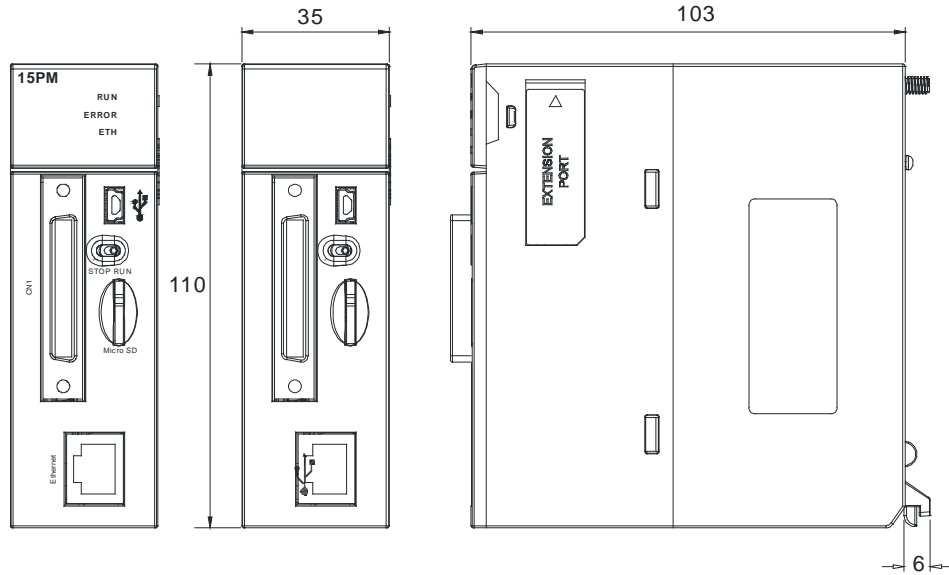

Unit: mm

● AH20MC-5A

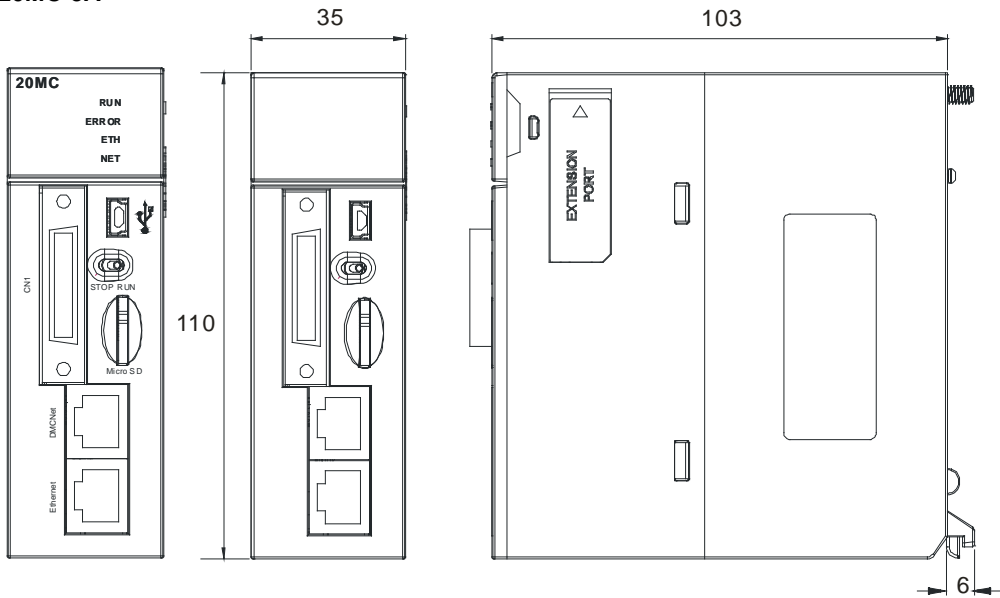

Unit: mm

● I/O extension cable, and external terminal module

1. 36-pin I/O extension cable for AH04HC-5A and AH20MC-5: UC-ET010-13B

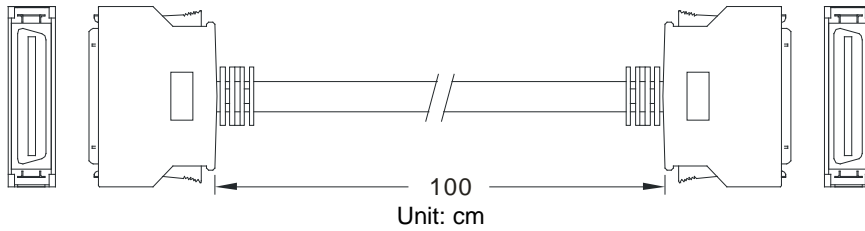

2

2. External terminal module for AH04HC-5A and AH20MC-5A: UB-10-IO16C

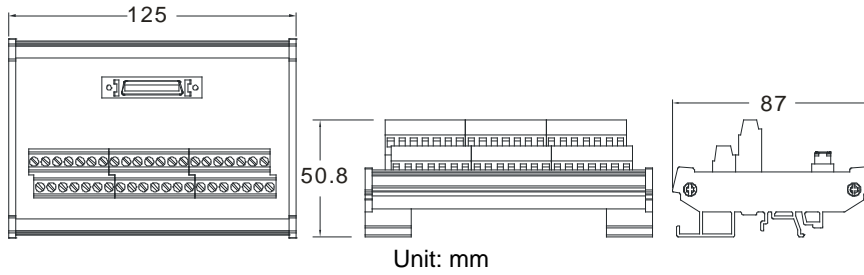

Unit: mm

3. 50-pin I/O extension cable for AH10PM-5A and AH15PM-5A: UC-ET010-15B

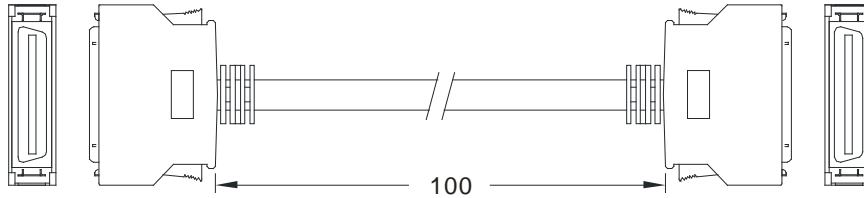

Unit: cm

4. External terminal module for AH10PM-5A: UB-10-IO24CC

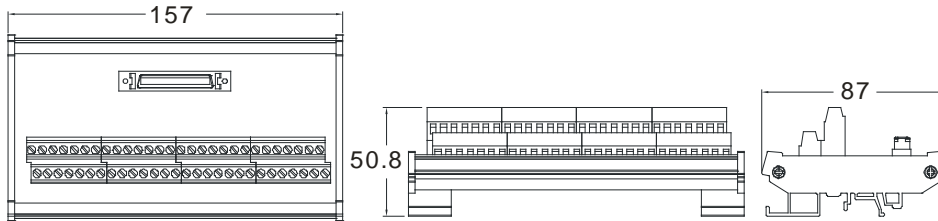

Unit: mm

5. External terminal module for AH15PM-5A: UB-10-IO34CC

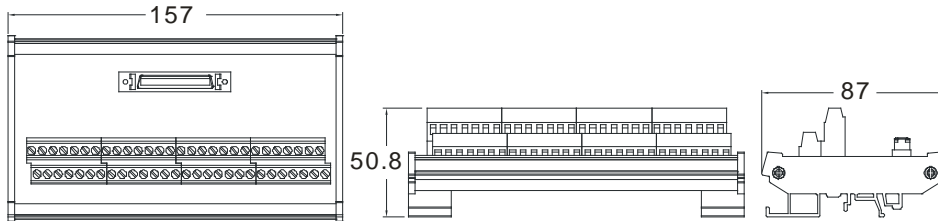

Unit: mm

2.8.4 Arrangement of Input/Output Terminals

- AH02HC-5A

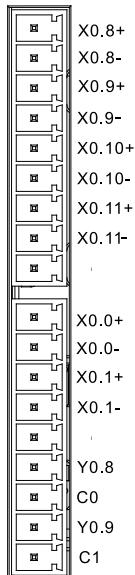

Terminal	Function	Terminal	Function
	Count		Count
X0.8+	CntA0+	X0.0+	Rst0+
X0.8-	CntA0-	X0.0-	Rst0-
X0.9+	CntB0+	X0.1+	Rst1+
X0.9-	CntB0-	X0.1-	Rst1-
X0.10+	CntA1+	Y0.8	Out0
X0.10-	CntA1-	C0	COM0
X0.11+	CntB1+	Y0.9	Out1
X0.11-	CntB1-	C1	COM1

● AH04HC-5A

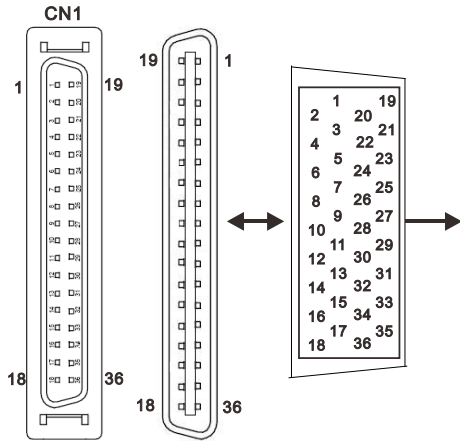

Pin	Terminal	Function	Pin	Terminal	Function
		Count			Count
1	C3	COM3	19	Y0.11	Out3
2	C2	COM2	20	Y0.10	Out2
3	C1	COM1	21	Y0.9	Out1
4	C0	COM0	22	Y0.8	Out0
5	-	-	23	-	-
6	-	-	24	-	-
7	X0.3-	Rst3-	25	X0.3+	Rst3+
8	X0.15-	CntB3-	26	X0.15+	CntB3+
9	X0.14-	CntA3-	27	X0.14+	CntA3+
10	X0.2-	Rst2-	28	X0.2+	Rst2+
11	X0.13-	CntB2-	29	X0.13+	CntB2+
12	X0.12-	CntA2-	30	X0.12+	CntA2+
13	X0.1-	Rst1-	31	X0.1+	Rst1+
14	X0.11-	CntB1-	32	X0.11+	CntB1+
15	X0.10-	CntA1-	33	X0.10+	CntA1+
16	X0.0-	Rst0-	34	X0.0+	Rst0+
17	X0.9-	CntB0-	35	X0.9+	CntB0+
18	X0.8-	CntA0-	36	X0.8+	CntA0+

2

● AH05PM-5A

Terminal	Function		Terminal	Function	
	Pulse	Count		Pulse	Count
S/S	S/S	S/S	Y0.1+	B0+	-
X0.0	PG0	Rst0	Y0.1-	B0-	-
X0.1	PG1	-	Y0.2+	A1+	-
X0.8	MPGA	CntA0	Y0.2-	A1-	-
X0.9	MPGB	CntB0	Y0.3+	B1+	-
X0.12	DOG0	-	Y0.3-	B1-	-
X0.13	DOG1	-	Y0.8	CLR0	-
Y0.0+	A0+	-	Y0.9	CLR1	-
Y0.0-	A0-	-	COM	-	-

2

● AH10PM-5A

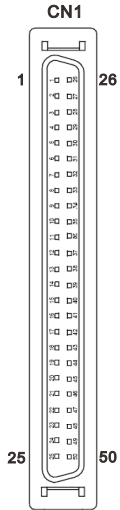

Pin	Terminal	Function		Pin	Terminal	Function	
		Pulse	Count			Pulse	Count
1	C3	COM3	-	26	Y0.11	CLR3/B5	-
2	C2	COM2	-	27	Y0.10	CLR2/A5	-
3	C1	COM1	-	28	Y0.9	CLR1/B4	-
4	C0	COM0	-	29	Y0.8	CLR0/A4	-
5	NC	-	-	30	NC	-	-
6	Y0.7-	B3-	-	31	Y0.7+	B3+	-
7	Y0.6-	A3-	-	32	Y0.6+	A3+	-
8	Y0.5-	B2-	-	33	Y0.5+	B2+	-
9	Y0.4-	A2-	-	34	Y0.4+	A2+	-
10	Y0.3-	B1-	-	35	Y0.3+	B1+	-
11	Y0.2-	A1-	-	36	Y0.2+	A1+	-
12	Y0.1-	B0-/CLR5-	-	37	Y0.1+	B0+/CLR5+	-
13	Y0.0-	A0-/CLR4-	-	38	Y0.0+	A0+/CLR4+	-
14	NC	-	-	39	NC	-	-
15	NC	-	-	40	S/S	S/S	S/S
16	X0.15	DOG3	CntB3/CntB5	41	X0.14	DOG2	CntB3/CntA5
17	X0.13	DOG1	CntB2/CntB4	42	X0.12	DOG0	CntA2/CntA4
18	X0.11	DOG5	CntB1	43	X0.10	DOG4	CntA1
19	X0.9	MPGB	CntB0	44	X0.8	MPGA	CntA0
20	NC	-	-	45	NC	-	-
21	NC	-	-	46	NC	-	-
22	X0.3-	Pg3-	Rst3-/Rst5-	47	X0.3+	Pg3+	Rst3+/Rst5+
23	X0.2-	Pg2-	Rst2-/Rst4-	48	X0.2+	Pg2+	Rst2+/Rst4+
24	X0.1-	Pg1-	Rst1-	49	X0.1+	Pg1+	Rst1+
25	X0.0-	Pg0-	Rst0-	50	X0.0+	Pg0+	Rst0+

● AH15PM-5A

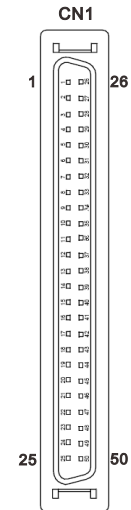

Pin	Terminal	Function		Pin	Terminal	Function	
		Pulse	Count			Pulse	Count
1	Y0.11	CLR3	-	26	Y0.10	CLR2	-
2	Y0.9	CLR1	-	27	Y0.8	CLR0	-
3	COM	COM	-	28	Y0.7+	B3+	-
4	Y0.7-	B3-	-	29	Y0.6+	A3+	-
5	Y0.6-	A3-	-	30	Y0.5+	B2+	-
6	Y0.5-	B2-	-	31	Y0.4+	A2+	-
7	Y0.4-	A2-	-	32	Y0.3+	B1+	-
8	Y0.3-	B1-	-	33	Y0.2+	A1+	-
9	Y0.2-	A1-	-	34	Y0.1+	B0+	-
10	Y0.1-	B0-	-	35	Y0.0+	A0+	-
11	Y0.0-	A0-	-	36	S/S	S/S	S/S
12	X1.5	CHG3	-	37	X1.4	CHG2	-
13	X1.3	CHG1	-	38	X1.2	CHG0	-
14	X1.1	LSN3	-	39	X1.0	LSP3	-
15	X0.15	LSN2	CntB3/CntB5	40	X0.14	LSP2	CntB3/CntA5
16	X0.13	LSN1	CntB2/CntB4	41	X0.12	LSP1	CntA2/CntA4
17	X0.11	LSN0	CntB1	42	X0.10	LSP0	CntA1
18	X0.9-	MPGB-	CntB0-	43	X0.9+	MPGB+	CntB0+
19	X0.8-	MPGA-	CntA0-	44	X0.8+	MPGA+	CntA0+
20	X0.7	DOG3	-	45	X0.6	DOG2	-
21	X0.5	DOG1	-	46	X0.4	DOG0	-
22	X0.3-	Pg3-	Rst3-/Rst5-	47	X0.3+	Pg3+	Rst3+/Rst5+
23	X0.2-	Pg2-	Rst2-/Rst4-	48	X0.2+	Pg2+	Rst2+/Rst4+

24	X0.1-	Pg1-	Rst1-	49	X0.1+	Pg1+	Rst1+
25	X0.0-	Pg0-	Rst0-	50	X0.0+	Pg0+	Rst0+

● AH20MC-5A

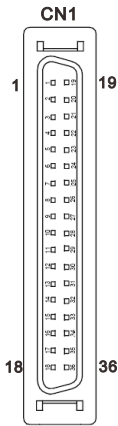

Pin	Terminal	Function		Pin	Terminal	Function	
		Pulse	Count			Pulse	Count
1	C3	-	COM3	19	Y0.11	-	Out3
2	C2	-	COM2	20	Y0.10	-	Out2
3	C1	-	COM1	21	Y0.9	-	Out1
4	C0	-	COM0	22	Y0.8	-	Out0
5	NC	-	-	23	NC	-	-
6	NC	-	-	24	NC	-	-
7	X0.3-	-	Rst3-/Rst5-	25	X0.3+	-	Rst3+/Rst5+
8	X0.15-	DOG3-	CntB3-/ CntB5+	26	X0.15+	DOG3+	CntB3+/CntB5+
9	X0.14-	DOG2-	CntA3-/ CntA5+	27	X0.14+	DOG2+	CntA3+/CntA5+
10	X0.2-	-	Rst2-/Rst4-	28	X0.2+	-	Rst2+/Rst4+
11	X0.13-	DOG1-	CntB2-/ CntB4-	29	X0.13+	DOG1+	CntB2+/CntB4+
12	X0.12-	DOG0-	CntA2-/ CntA4-	30	X0.12+	DOG0+	CntA2+/CntA4+
13	X0.1-	-	Rst1-	31	X0.1+	-	Rst1+
14	X0.11-	DOG5-	CntB1-	32	X0.11+	DOG5+	CntB1+
15	X0.10-	DOG4-	CntA1-	33	X0.10+	DOG4+	CntA1+
16	X0.0-	-	Rst0-	34	X0.0+	-	Rst0+
17	X0.9-	MPGB-	CntB0-	35	X0.9+	MPGB+	CntB0+
18	X0.8-	MPGA-	CntA0-	36	X0.8+	MPGA+	CntA0+

2

● External terminal module

1. External terminal module for AH04HC-5A: UB-10-IO16C

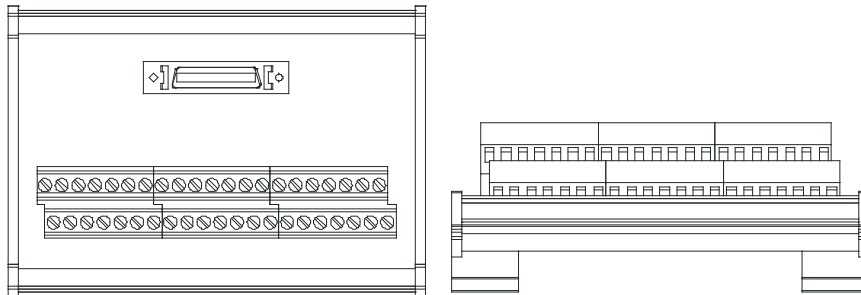

C3	C2	C1	C0	N/C	N/C	X0.3-	X0.15-	X0.14-	X0.2-	X0.13-	X0.12-	X0.1-	X0.11-	X0.10-	X0.0-	X0.9-	X0.8-	24G	24G	FE
Y0.11	Y0.10	Y0.9	Y0.8	N/C	N/C	X0.3+	X0.15+	X0.14+	X0.2+	X0.13+	X0.12+	X0.1+	X0.11+	X0.10+	X0.0+	X0.9+	X0.8+	N/C	24V	24V

2. External terminal module for AH10PM-5A: UB-10-IO24CC

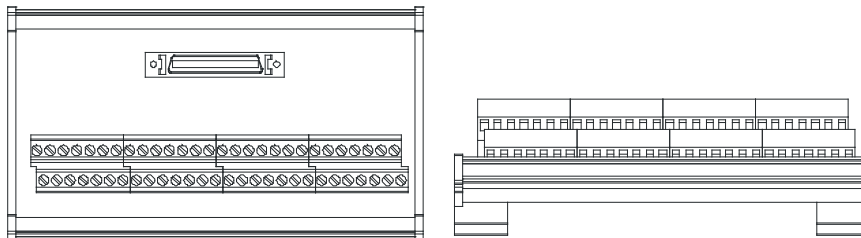

2

1 st from the upper left	C3	C2	C1	C0	N/C	Y0.7-	Y0.6-	Y0.5-	Y0.4-	Y0.3-	Y0.2-	Y0.1-	Y0.0-	N/C
15 th from the upper left	N/C	X0.15	X0.13	X0.11	X0.9	N/C	N/C	X0.3-	X0.2-	X0.1-	X0.0-	24G	24G	FE
1 st from the lower left	Y0.11	Y0.10	Y0.9	Y0.8	N/C	Y0.7+	Y0.6+	Y0.5+	Y0.4+	Y0.3+	Y0.2+	Y0.1+	Y0.0+	N/C
15 th from the lower left	S/S	X0.14	X0.12	X0.10	X0.8	N/C	N/C	X0.3+	X0.2+	X0.1+	X0.0+	N/C	24V	24V

3. External terminal module for AH15PM-5A: UB-10-IO34CC

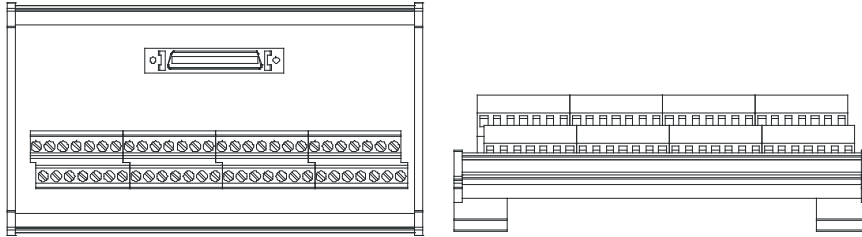

1 st from the upper left	Y0.11	Y0.9	COM	Y0.7-	Y0.6-	Y0.5-	Y0.4-	Y0.3-	Y0.2-	Y0.1-	Y0.0-	X1.5	X1.3	X1.1
15 th from the upper left	X0.15	X0.13	X0.11	X0.9-	X0.8-	X0.7	X0.5	X0.3-	X0.2-	X0.1-	X0.0-	24G	24G	FE
1 st from the lower left	Y0.10	Y0.8	Y0.7+	Y0.6+	Y0.5+	Y0.4+	Y0.3+	Y0.2+	Y0.1+	Y0.0+	S/S	X1.4	X1.2	X1.0
15 th from the lower left	X0.14	X0.12	X0.10	X0.9+	X0.8+	X0.6	X0.4	X0.3+	X0.2+	X0.1+	X0.0+	N/C	24V	24V

4. External terminal module for AH20MC-5A: UB-10-IO16C

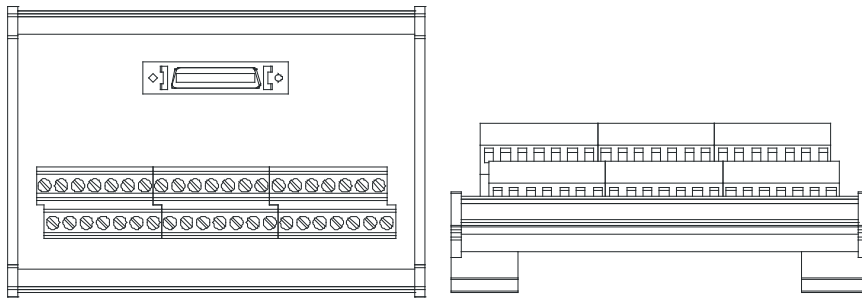

C3	C2	C1	C0	N/C	N/C	X0.3-	X0.15-	X0.14-	X0.2-	X0.13-	X0.12-	X0.1-	X0.11-	X0.10-	X0.0-	X0.9-	X0.8-	24G	24G	FE
Y0.11	Y0.10	Y0.9	Y0.8	N/C	N/C	X0.3+	X0.15+	X0.14+	X0.2+	X0.13+	X0.12+	X0.1+	X0.11+	X0.10+	X0.0+	X0.9+	X0.8+	N/C	24V	24V

2.8.5 Setting Parameters

(1) AH02HC-5A

Parameter Setting

AH02HC-5A

MDS Information | Normal Exchange Area

Module Name	AH02HC-5A
MDS Version	1.00.00
MDS Build Date	2013/12/11

Import File

Export File

Default

OK

Cancel

(2) AH04HC-5A

Parameter Setting

AH04HC-5A

MDS Information | Normal Exchange Area

Module Name	AH04HC-5A
MDS Version	1.00.00
MDS Build Date	2013/12/11

Import File

Export File

Default

OK

Cancel

(3) AH05PM-5A

Parameter Setting

AH05PM-5A

MDS Information | Normal Exchange Area

Module Name	AH05PM-5A
MDS Version	1.00.00
MDS Build Date	2012/07/14

Import File

Export File

Default

OK

Cancel

2

(4) AH10PM-5A

Parameter Setting

AH10PM-5A
 AHCPU and AH10PM D devic
 AHCPU and AH10PM M devic

AH10PM-5A

MDS Information | Normal Exchange Area

Module Name	AH10PM-5A
MDS Version	1.00.00
MDS Build Date	2012/07/14

(5) AH15PM-5A

Parameter Setting

AH15PM-5A
 AHCPU and AH15PM D devic
 AHCPU and AH15PM M devic

AH15PM-5A

MDS Information | Normal Exchange Area

Module Name	AH15PM-5A
MDS Latest Version	1.00.0
MDS Build Date	2013/01/16

(6) AH20MC-5A

Parameter Setting

AH20MC-5A
 AHCPU and AH20MC D devic
 AHCPU and AH20MC M devic

AH20MC-5A

MDS Information | Normal Exchange Area

Module Name	AH20MC-5A
MDS Version	1.00.00
MDS Build Date	2012/07/14

Please refer to AH500 Module Manual for more information about setting parameters.

2.9 Specifications for Remote Input/Output Modules

2.9.1 General Specifications

- AHRTU-DNET-5A

Item	Specifications
Communication type	CAN
Electrical isolation	500 V DC
Connector type	Removable connector (5.08 mm)
Data type	I/O polled, and explicit
Communication speed	Standard mode: 125 kbps, 250 kbps, and 500 kbps Extended mode: 10 kbps, 20 kbps, 50 kbps, 125 kbps, 250 kbps, 500 kbps, 800 kbps, and 1 Mbps
Communication cable	Delta shielded twisted pair (Two communication cables, two power cables, and one shielded cable)
Weight	150g

- AHRTU-PFBS-5A

Item	Specifications
Communication type	High-speed RS-485
Electrical isolation	500 V DC
Connector type	DB9 connector
Data type	Cyclic data exchange
Communication speed	9.6 kbps, 19.2 kbps, 45.45 kbps, 93.75 kbps, 187.5 kbps, 500 kbps, 1.5 Mbps, 3 Mbps, 6 Mbps, and 12 Mbps are supported.
Communication cable	Shielded twisted pair cable
Weight	200g

- AHRTU-ETHN-5A

Item	Specifications
Communication type	EtherNet/IP, MODBUS TCP
Protocol	BOOTP, DHCP, NTP
Communication speed	10/100 Mbps Auto-Detection
Communication Interface	RJ-45 with Auto MDI/MDIX
Numbers of the Ethernet Communication Port	2 (X1, X2)
Weight	177g

2.9.2 Profiles

● AHRTU-DNET-5A

1. Profile

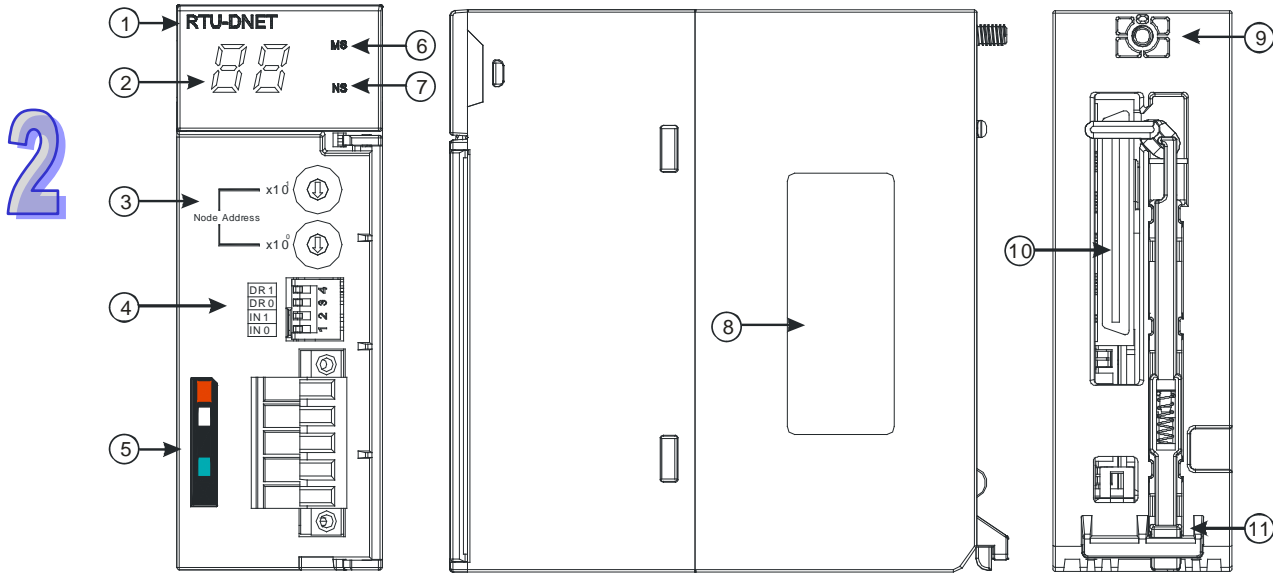

Number	Name	Description
1	Model name	Model name of the module
2	Seven-segment display	Display
3	Address knob	Setting the address
4	Function switch	Setting the functions
5	DeviceNet connector	DeviceNet is used to interconnect control devices for data exchange.
6	MS LED indicator	Indicating the status of the module
7	NS LED indicator	Indicating the status of the network
8	Label	Nameplate
9	Set screw	Fixing the module
10	Connector	Connecting the module and a backplane
11	Projection	Fixing the module

2. Address knobs

It is used to set the node address of AHRTU-DNET-5A on a DeviceNet network. (Node addresses range from 0 to 63.)

Setting	Description
0...63	Available nodes on a DeviceNet network
64...99	Unavailable nodes on a DeviceNet network

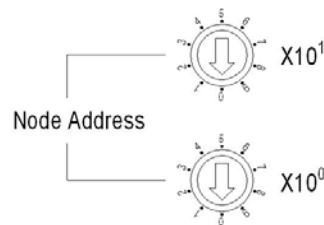

Example: If users want to set the communication address of AHRTU-DNET-5A to 26, they can turn the knob corresponding to $x10^1$ to 2, and turn the knob corresponding to $x10^0$ to 6.

Points for attention:

- When the power supply is cut off, the node address is set. After the setting of the node address is complete, AHRTU-DNET-5A can be supplied with power.
- If AHRTU-DNET-5A is running, changing the node address is unavailable.
- Please use a slotted screwdriver to turn the knobs with care, and do not scrape them.

3. Function switch

The function switch provides the following functions:

- Setting the working mode (IN 0)
- Setting the transmission speed of a DeviceNet network (DR 0~DR 1)

DR 1	DR 0	Transmission speed
OFF	OFF	125 kbps
OFF	ON	250 kbps
ON	OFF	500 kbps
ON	ON	Extended transmission speed

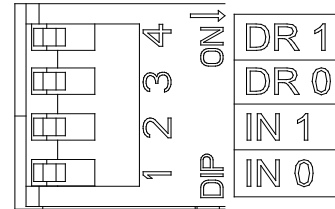

IN 1	Reserved	
IN 0	ON	Clearing the data in the internal storage in AHRTU-DNET-5A
	OFF	No action

Points for attention:

- When the power supply is cut off, the functions are set. After the setting of the functions is complete, AHRTU-DNET-5A can be supplied with power.
- If AHRTU-DNET-5A is running, changing the functions is unavailable.
- Please use a slotted screwdriver to adjust the DIP switch with care, and do not scrape them.

4. DeviceNet connector

Pin	Signal	Color	Description
1	V+	Red	24 V DC
2	CAN_H	White	Signal (positive pole)
3	SHIELD	-	It is connected to a shielded cable.
4	CAN_L	Blue	Signal (negative pole)
5	V-	Black	0 V DC

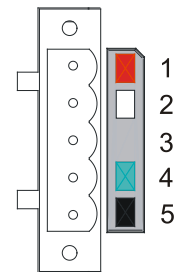

● **AHRTU-PFBS-5A**

1. Profile

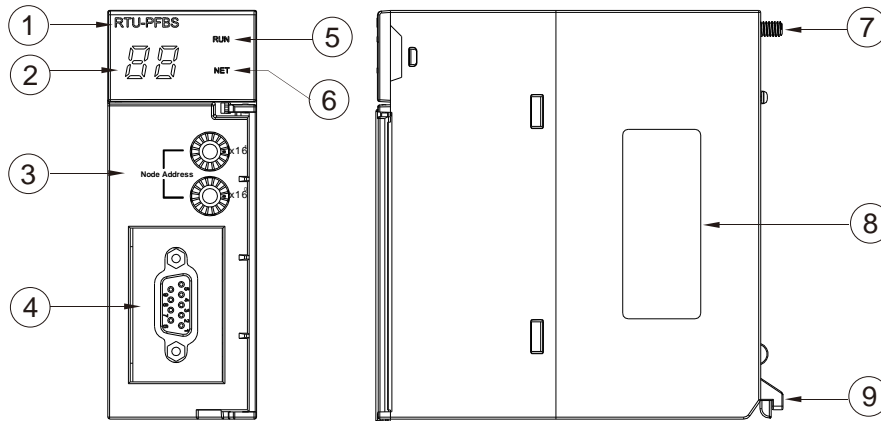

1. Model name	2. Seven-segment display	3. Address knobs
4. PROFIBUS-DP port	5. RUN LED indicator	6. NET LED indicator
7. Set screw	8. Label	9. Projection

2

2. Definitions of the pins in the PROFIBUS-DP port

PIN	PIN name	Description
1	--	N/C
2	--	N/C
3	RxD/TxD-P	Receiving/Sending data (P (B))
4	--	N/C
5	DGND	Data reference potential (C)
6	VP	Supply positive voltage
7	--	N/C
8	RxD/TxD-N	Receiving/Sending data (N (A))
9	--	N/C

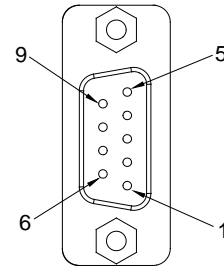

3. Setting a PROFIBUS node address by means of the address knobs

The address knobs of AHRTU-PFBS-5A are used for setting the node address of AH10PFBS-5A on a PROFIBUS-DP network. There are two address knobs. They are a knob corresponding to $x16^0$, and a knob corresponding to $x16^1$. The range for one address knob is 0~F.

The range for setting the node address is described below.

Address	Definition
H'1~H'7D	Valid PROFIBUS address
H'0 or H'7E~H'FF	Invalid PROFIBUS address

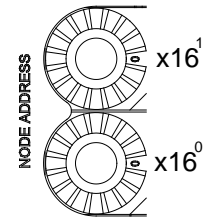

Example: If users need to set the node address of AHRTU-PFBS-5A to 26 (decimal value), they have to turn the knob corresponding to $x16^1$ to "1" and the knob corresponding to $x16^0$ to "A".

$$26 \text{ (decimal value)} = 1A \text{ (hexadecimal value)} = 1 \times 16^1 + A \times 16^0.$$

Points for attention:

- If users set the node address of AHRTU-PFBS-5A when AHRTU-PFBS-5A is not supplied with power, they have to power AHRTU-PFBS-5A after the node address of AHRTU-PFBS-5A is set.
- If users change the node address of AHRTU-PFBS-5A when AHRTU-PFBS-5A is powered, the change will not take effect immediately after the node address of AHRTU-PFBS-5A is changed, and it will take effect after the users cut off the power supplied to AHRTU-PFBS-5A and then power AHRTU-PFBS-5A again.
- To prevent the address knobs on AHRTU-PFBS-5A from being scratched, please carefully use a slotted screwdriver to rotate the address knobs on AHRTU-PFBS-5A.

● **AHRTU-ETHN-5A**

1. Profile

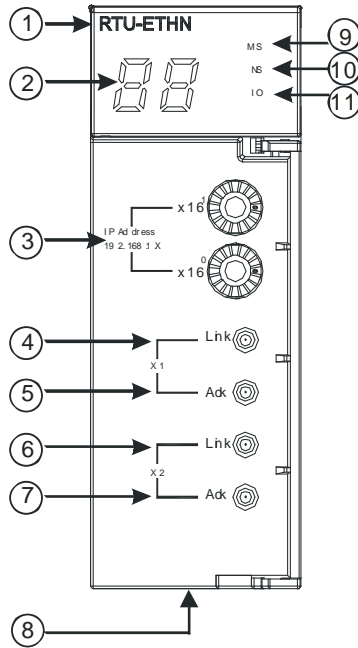

2

Number	Name
1	Model name
2	Seven-segment display
3	Address knobs
4	X1 Link indicator
5	X1 Ack indicator
6	X2 Link indicator
7	X2 Ack indicator
8	RJ45 port x1 / x2
9	MS LED indicator
10	NS LED indicator
11	I/O indicator

2. Ethernet Port

Pin definition for the Ethernet port

Pin	Signal	Description	RJ-45
1	TX+	Transmitting data (positive pole)	
2	TX-	Transmitting data (negative pole)	
3	RX+	Receiving data (positive pole)	
4	-	-	
5	-	-	
6	RX-	Receiving data (negative pole)	
7	-	-	
8	-	-	

3. Address knobs

The IP address of the AHRTU-ETHN-5A series can be set via the address knobs; the default address range is 192.168.1.x and x should be set from 00 to FF.

Address	Description	
00 ~ 0xFD	1. Valid IP address: 192.168.1.x, x = 1 ~ FD, (1~253) 2. 0x00: set up via EIP Builder	
0xFE	Go to the firmware update mode	
0xFF	Restore to factory defaults and reboot to have the defaults to take effect.	

2

2.9.3 Dimensions

■ AHRTU-DNET-5A

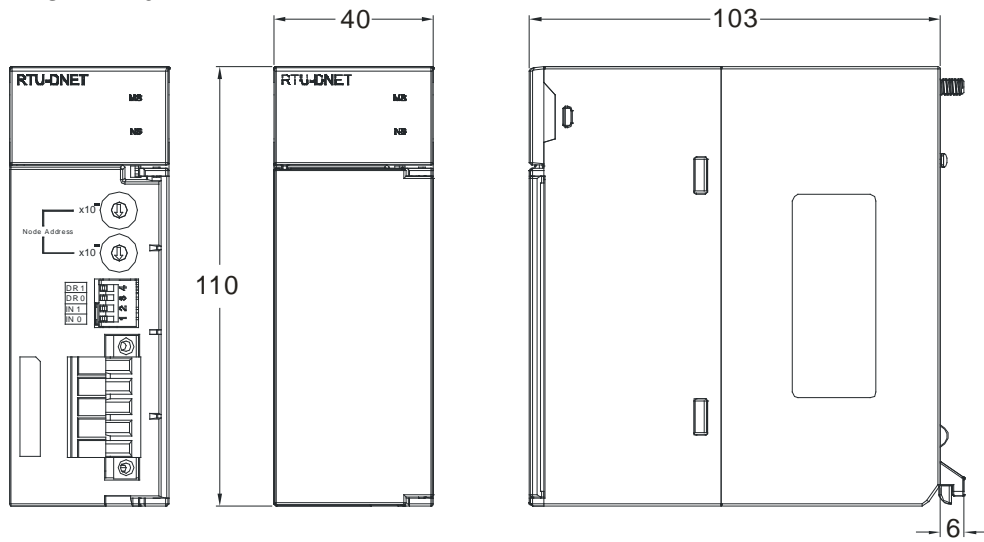

Unit: mm

■ **AHRTU-PFBS-5A**

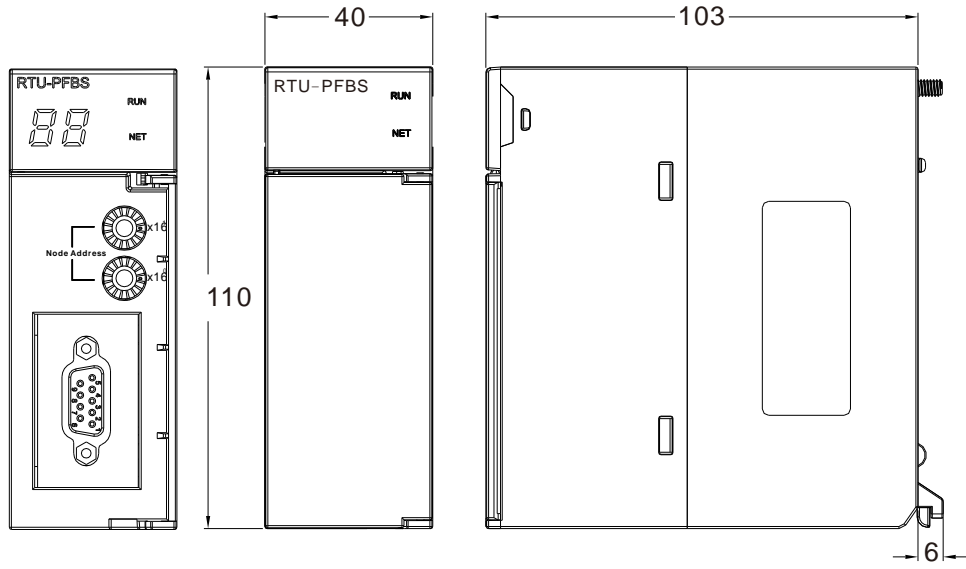

Unit: mm

● **AHRTU-ETHN-5A**

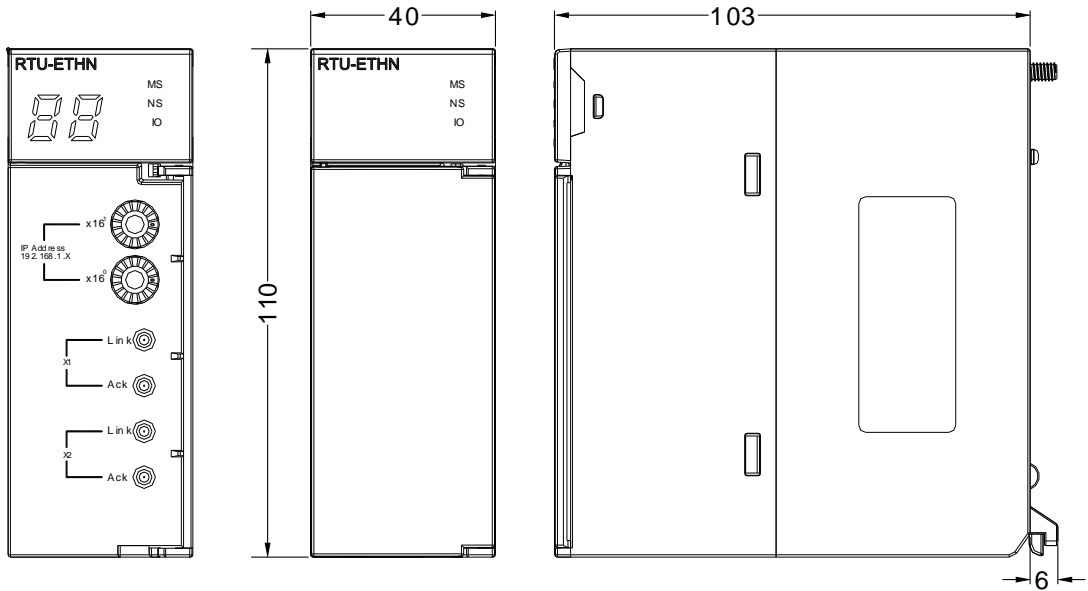

Unit: mm

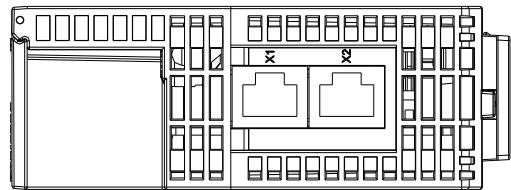

2

2.10 Specifications for Power Supply Modules

2.10.1 General Specifications

■ AHPS05-5A

Item	Specifications
Supply voltage	100~240 V AC (-15%~10%) 50/60 Hz±5%
Action specifications	If the input power supply is larger than 85 V AC, the power supply module can function normally.
Allowable instantaneous power failure time	If the instantaneous power failure time is within ten milliseconds, the power supply module keeps running.
Fuse	4 A/250 V AC
Inrush current	45 A within 1 millisecond at 115 V AC
24 V DC output	The maximum current is 2.5 A. It is only for a backplane.
Power protection	The 24 V DC output is equipped with the short circuit protection and the overcurrent protection.
Surge voltage withstand level	1,500 V AC (Primary-secondary), 1,500 V AC (Primary-PE), 500 V AC (Secondary-PE)
Insulation voltage	Above 5 MΩ (The voltage between all inputs/outputs and the ground is 500 V DC.)
Ground	The diameter of the ground should not be less than the diameters of the cables connected to the terminals L and N.

■ AHPS15-5A

Item	Specifications
Supply voltage	24 V DC (-35%, +30%)
Allowable instantaneous power failure time	10 milliseconds
Fuse	6.3 A/250 V AC
Inrush current	30 A within 100 milliseconds
24 V DC output	1.5 A
Maximum output power	36 W
Power protection	The 24 V DC output is equipped with the short circuit protection, the overcurrent protection, and the overvoltage protection.
Surge voltage withstand level	500 V AC
Ground	The diameter of the ground should be greater than 1.6 mm ² .
Weight	400g

2.10.2 Profiles

■ AHPS05-5A

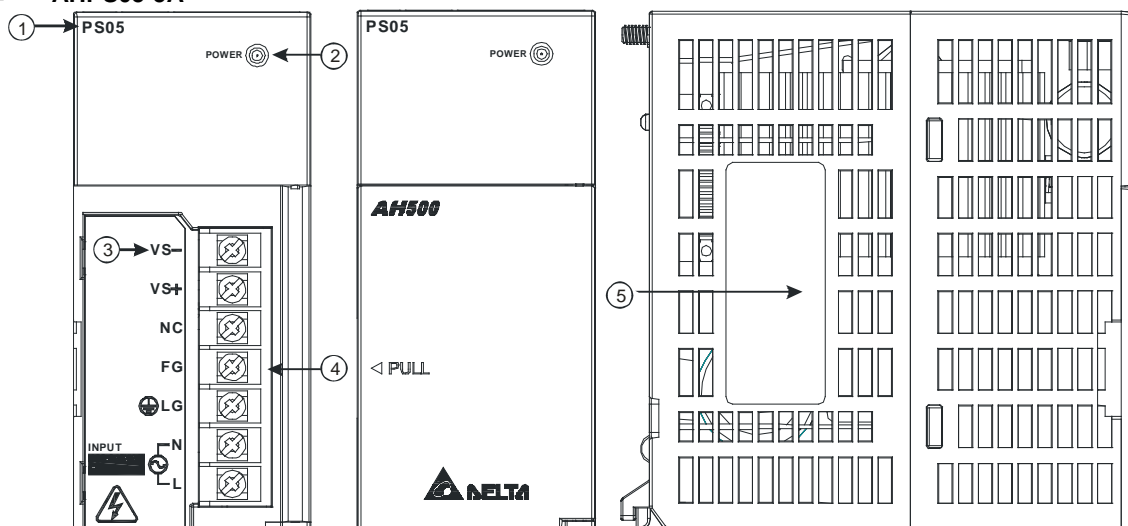

2

Number	Name	Description
1	Model name	Model name of the power supply module
2	POWER LED indicator (green)	Indicating the status of the power supply
3	Arrangement of the terminals	VS-: It is connected to the negative 24 V DC power supply. VS+: It is connected to the positive 24 V DC power supply. NC: No connection FG: Functional ground LG: Line ground L/N: AC power input
4	Terminal	Terminal for wiring
5	Label	Nameplate

2

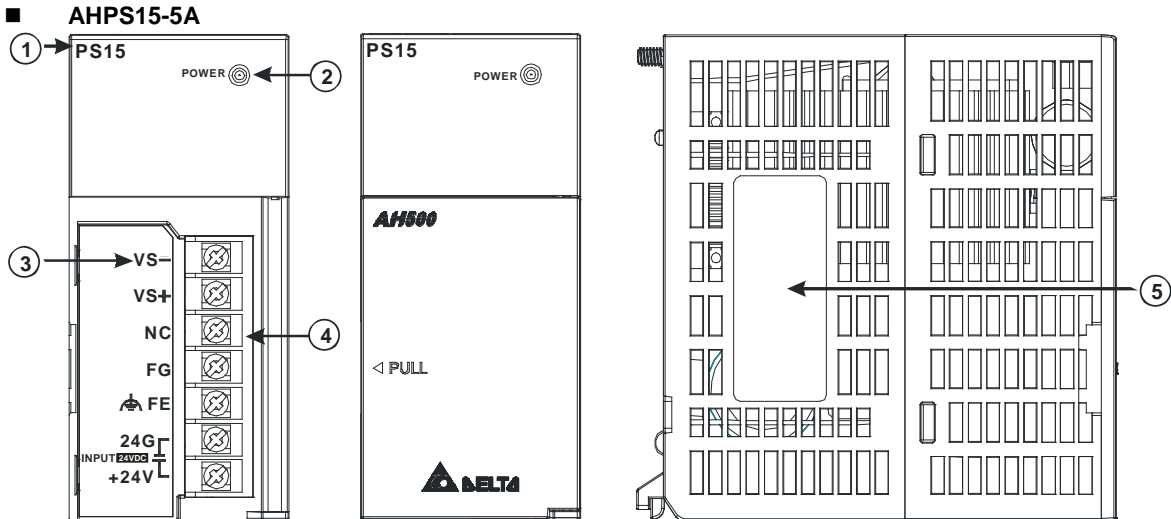

Number	Name	Description
1	Model name	Model name of the power supply module
2	POWER LED indicator (green)	Indicating the status of the power supply
3	Arrangement of the terminals	VS-: It is connected to the negative 24 V DC power supply. VS+: It is connected to the positive 24 V DC power supply. NC: No connection FG: Functional ground FE: Line ground 24G/+24V: DC power input
4	Terminal	Terminal for wiring
5	Label	Nameplate

2.10.3 Dimensions

■ AHPS05-5A

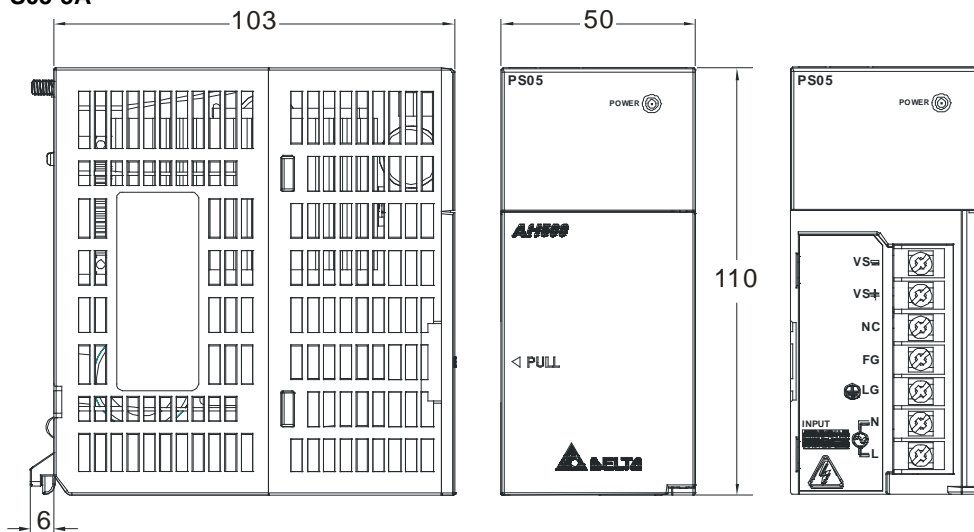

Unit: mm

■ AHPS15-5A

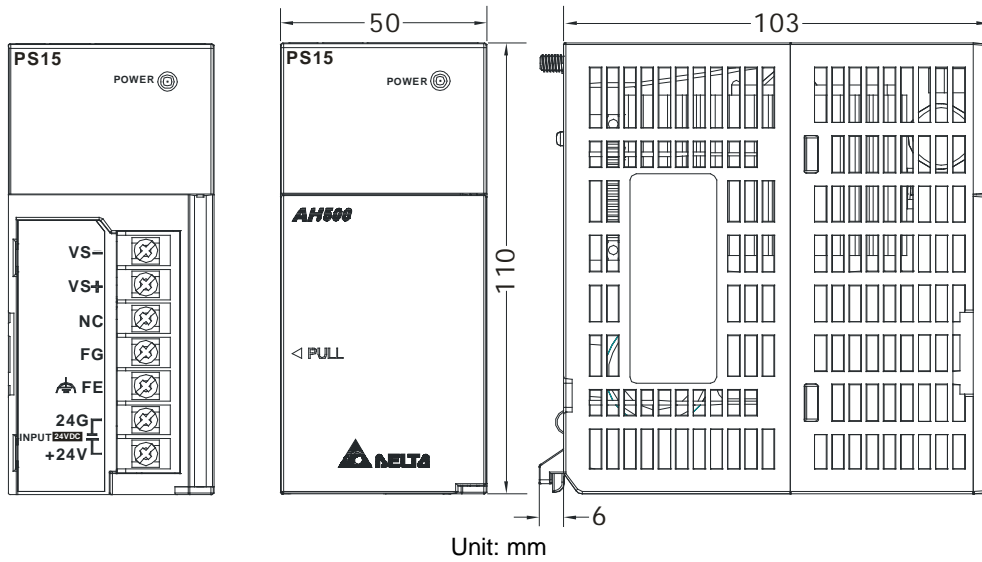

2.10.4 Arrangement of Terminals

■ AHPS05-5A

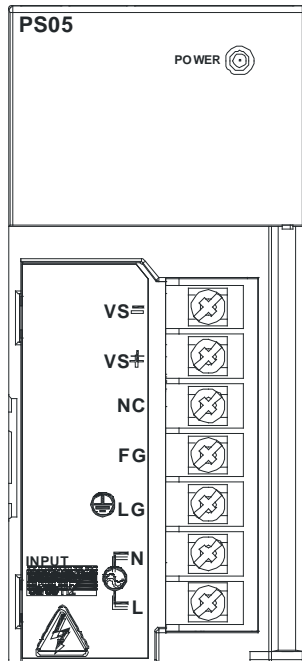

- VS-: It is connected to the negative 24 V DC power supply, and used to detect the external power supply.
- VS+: It is connected to the positive 24 V DC power supply, and used to detect the external power supply.
- NC: No connection
- FG: Functional ground
- LG: Line ground
- L/N: AC power input

2

■ AHPS15-5A

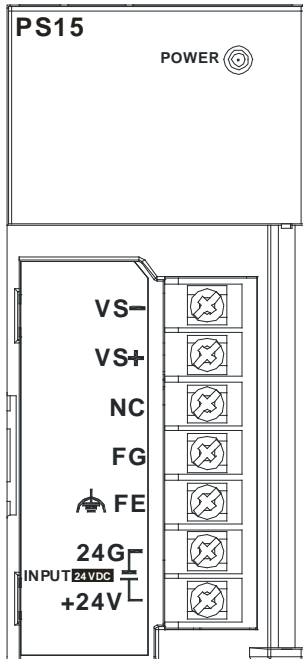

- VS-: It is connected to the negative 24 V DC power supply, and used to detect the external power supply.
- VS+: It is connected to the positive 24 V DC power supply, and used to detect the external power supply.
- NC: No connection
- FG: Functional ground
- FE: Line ground
- 24G/+24V: DC power input

2.11 Space Module, Backplanes, and Extension Cables

2.11.1 General Specifications

● Specifications for main backplanes

Model	AHBP04M1-5A	AHBP06M1-5A	AHBP08M1-5A	AHBP12M1-5A
Item				
Number of slots	4	6	8	12
Applicable power supply module	AHPS05-5A and AHPS15-5A			
Applicable input/output module	The AH500 series input/output modules can be installed.			

● Specifications for extension backplanes

Model	AHBP06E1-5A	AHBP08E1-5A
Item		
Number of slots	6	8
Applicable power supply module	AHPS05-5A and AHPS15-5A	
Applicable input/output module	Digital input/output modules, analog input/output modules, temperature measurement module, AH10SCM-5A and AH15SCM-5A	

● AHAADP01EF-5A/AHAADP02EF-5A

Item	Specifications
Connector type	155 Mbps 1*9 SC full-duplex optical fiber transceiver
Transmission interface	Optical fiber
Transmission speed	100 Mbps
Transmission distance	2 KM
Electric energy consumption	1.5 W
Insulation voltage	2,500 V DC

● **Dust cover AHASP01-5A**

Item	Specifications
Weight	85g

2.11.2 Profiles

■ **Space module AHASP01-5A**

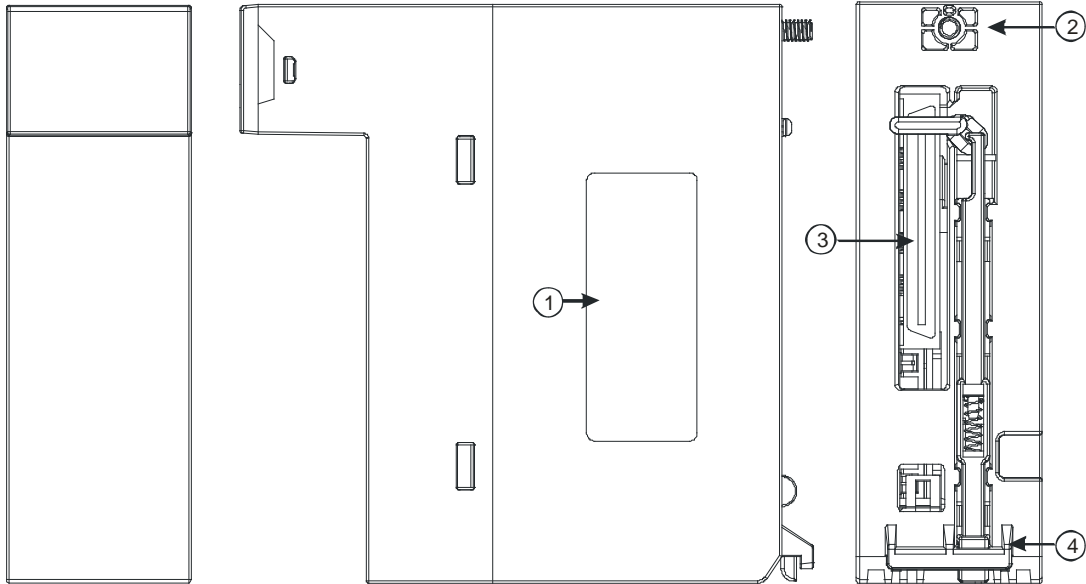

2

Number	Name	Description
1	Label	Nameplate
2	Set screw	Fixing the module
3	Connector	Connecting the module and a backplane
4	Projection	Fixing the module

■ **Profile of the main backplane AHBP08M1-5A**

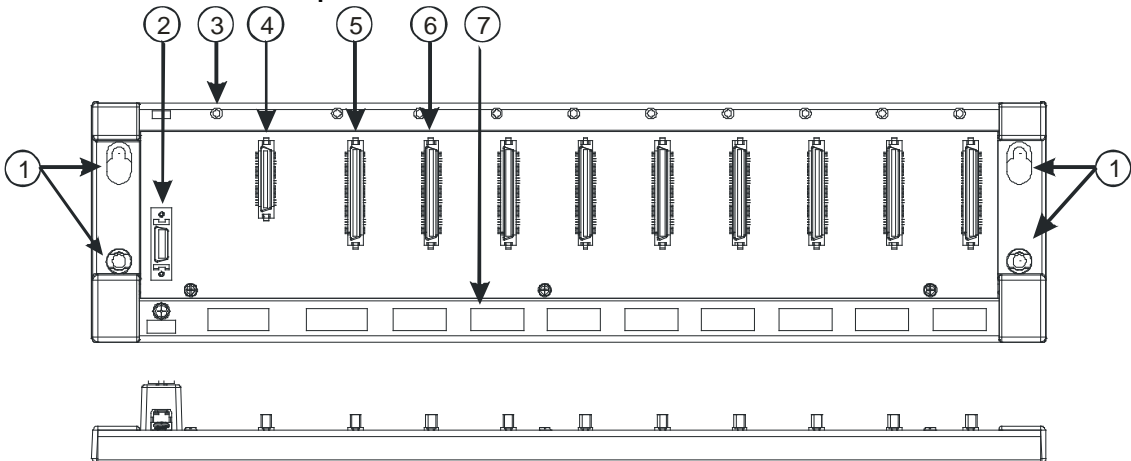

2

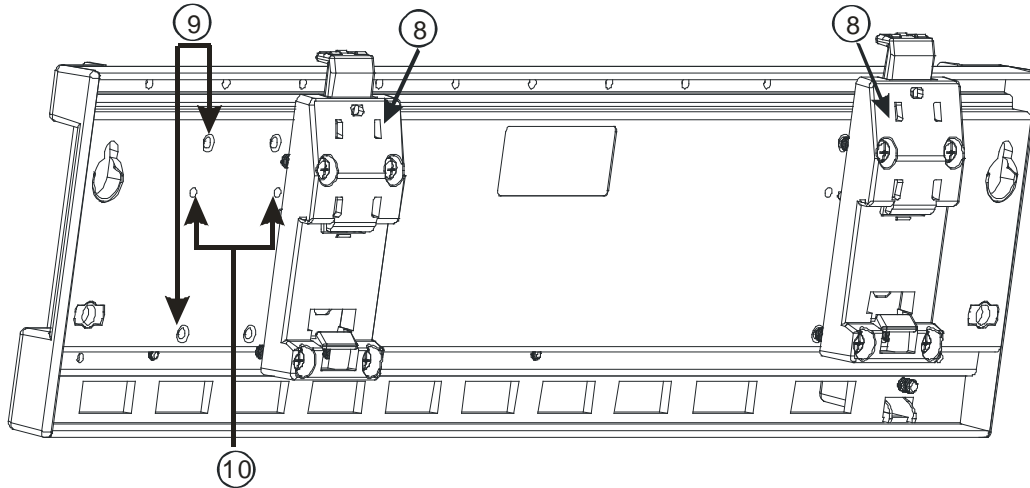

Number	Name	Description
1	Mounting hole	Fixing the backplane
2	Extension port	It is connected to an inferior backplane.
3	Mounting hole	After a module is installed, it is fixed by a screw.
4	Connector	Connecting the backplane and a power supply module
5	Connector	Connecting the backplane and a CPU module
6	Connector	Connecting the backplane and an input/output module
7	Hole	The projection under a module is inserted into this hole.
8	Mounting clip	Hanging a backplane on a DIN rail
9	Mounting hole	After a mounting clip is installed, it is fixed by screws.
10	Locating hole	A mounting clip is pressed into these locating holes.

■ Profile of the extension backplane AHBP08E1-5A

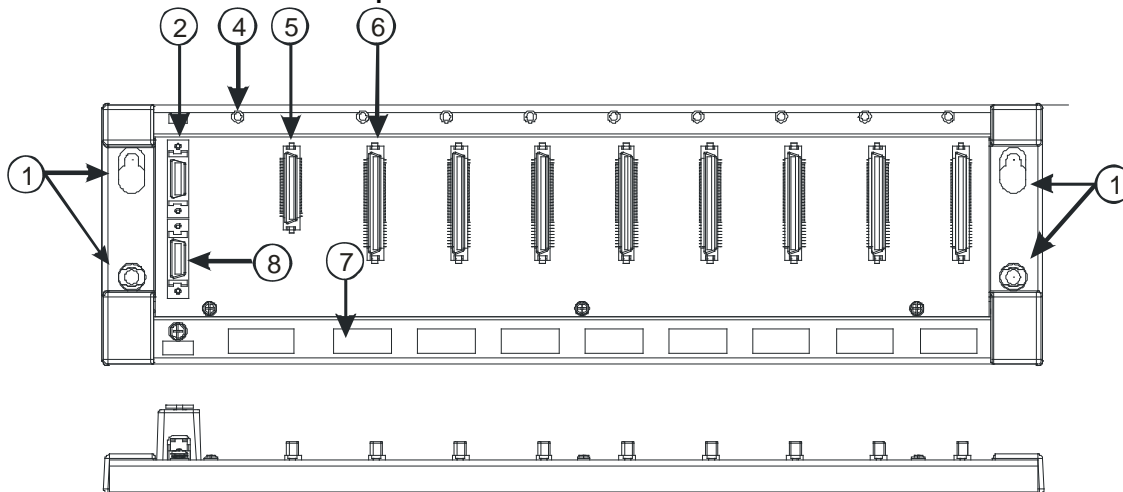

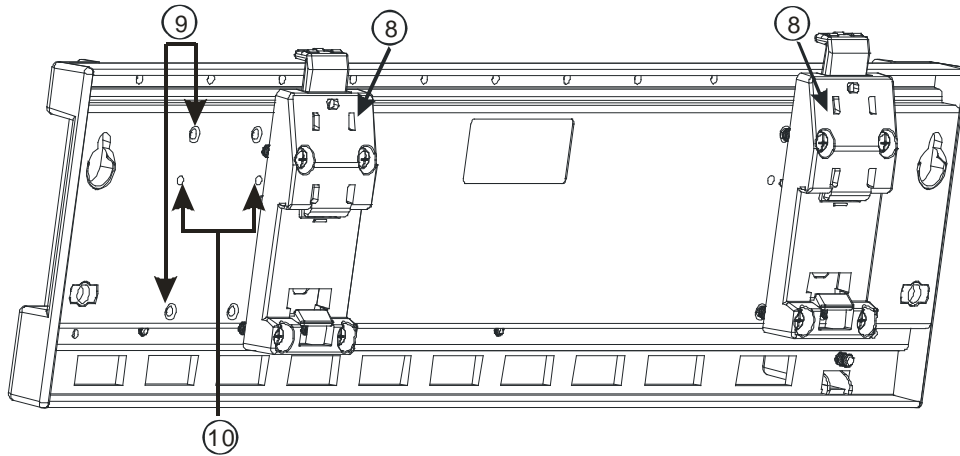

Number	Name	Description
1	Mounting hole	Fixing the backplane
2	Extension port 1	It is connected to a superior backplane.
3	Extension port 2	It is connected to an inferior backplane.
4	Connector	Connecting the backplane and a power supply module
5	Connector	Connecting the backplane and an input/output module
6	Mounting hole	After a module is installed, it is fixed by a screw.
7	Hole	The projection under a module is inserted into this hole.
8	Mounting clip	Hanging a backplane on a DIN rail
9	Mounting hole	After a mounting clip is installed, it is fixed by screws.
10	Locating hole	A mounting clip is pressed into these locating holes.

■ Extension cable

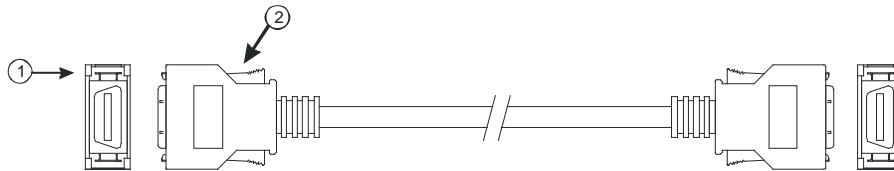

Number	Name	Description
1	Connector	Connecting backplanes 1. AHACAB06-5A 2. AHACAB10-5A 3. AHACAB15-5A 4. AHACAB30-5A
2	Clip	Fixing the connector

2

■ AHAADP01EF-5A/AHAADP02EF-5A

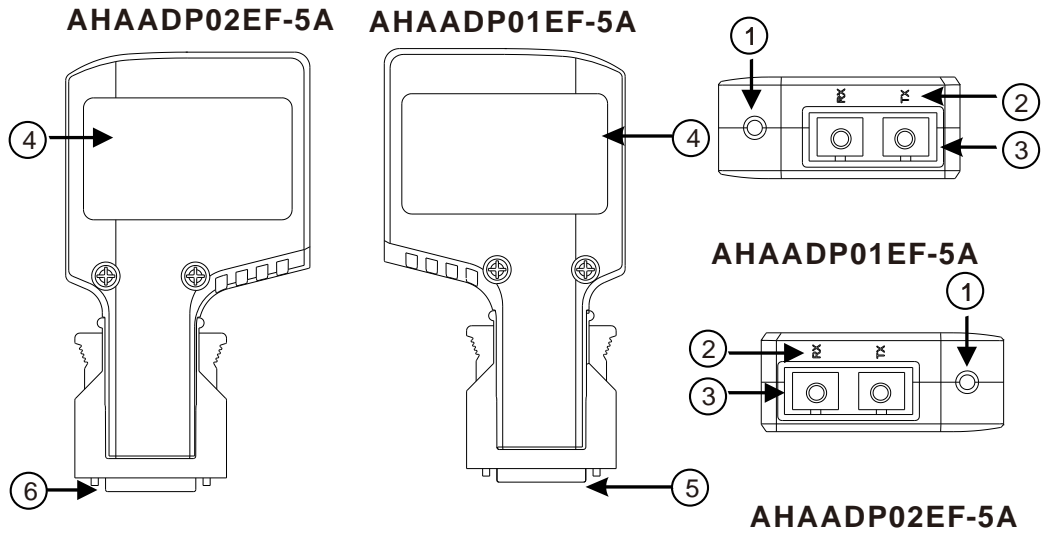

Number	Name
1	Connection/Communication LED indicator
2	Descriptions of the optical fiber ports (TX/RX)
3	Optical fiber ports
4	Label
5	Connector

2.11.3 Dimensions

■ Space module AHASP01-5A

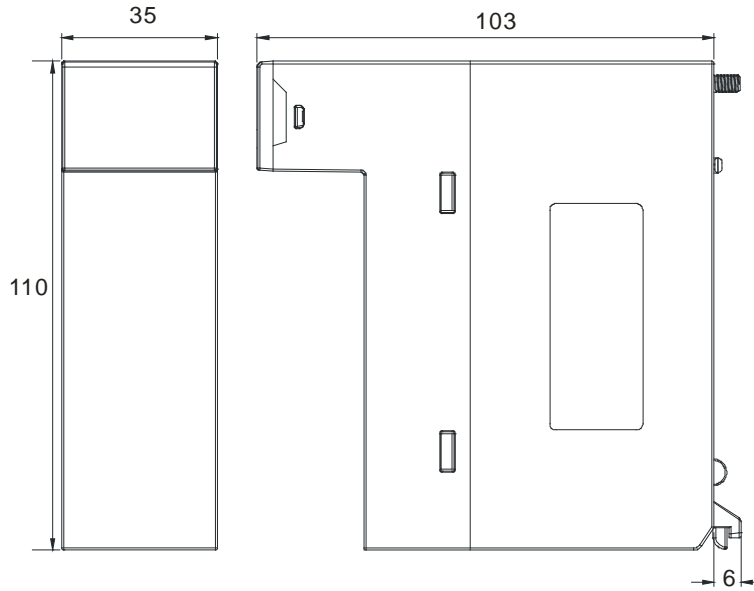

Unit: mm

■ Main backplane AHBP04M1-5A

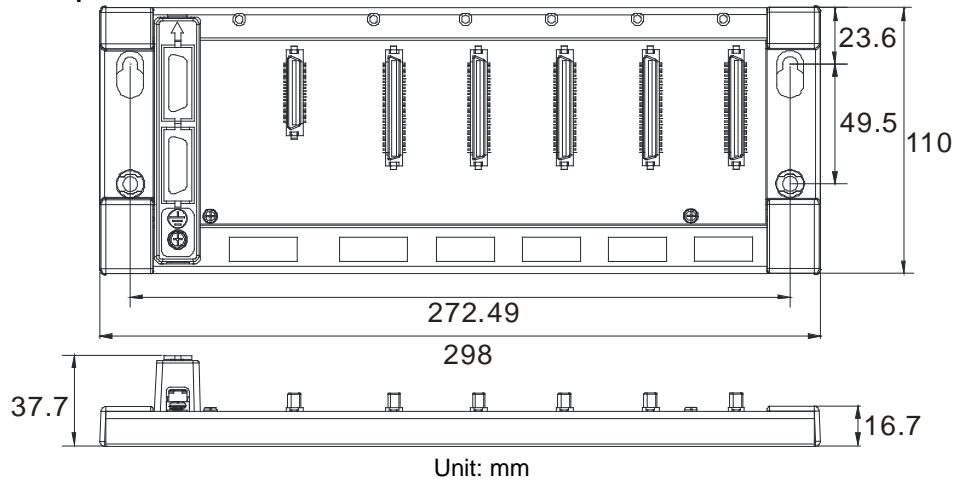

■ Main backplane AHBP06M1-5A

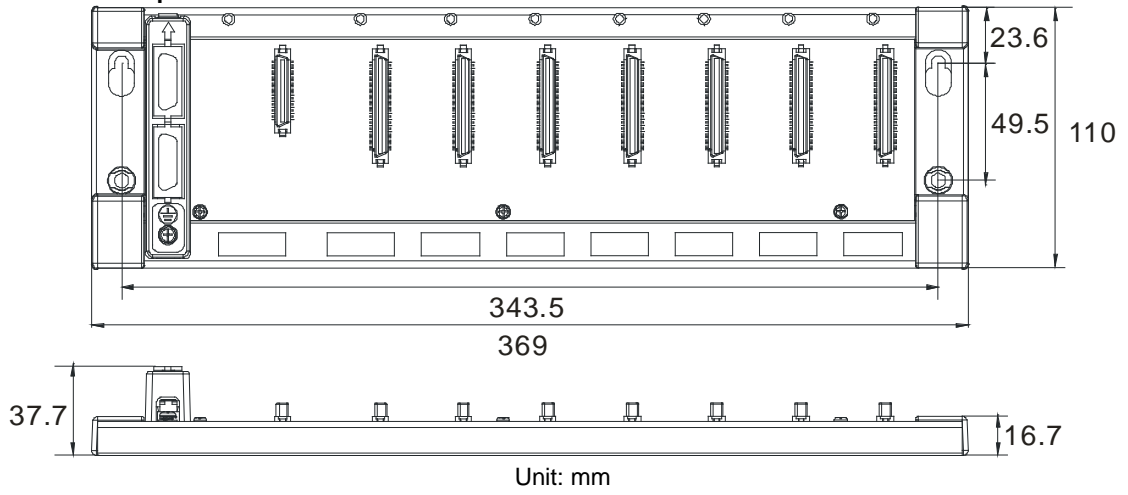

■ Main backplane AHBP08M1-5A

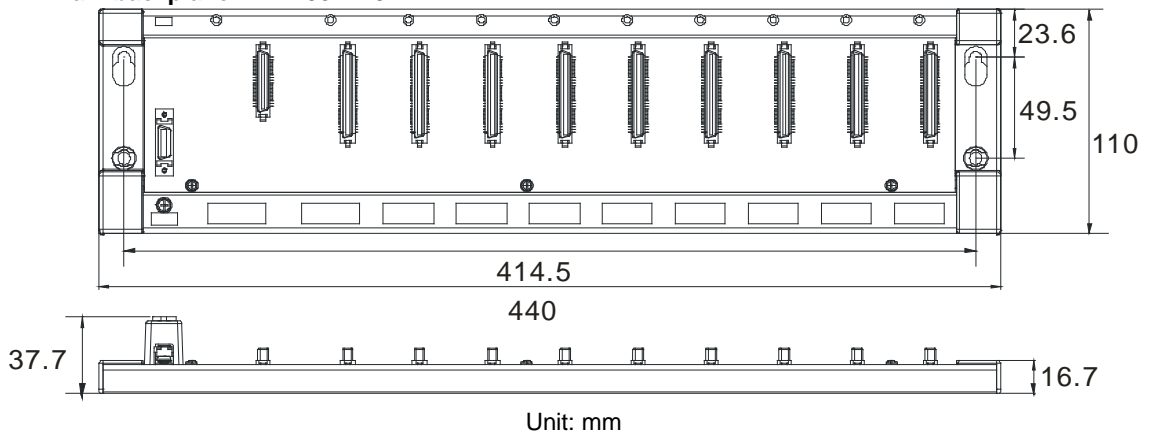

2

■ Main backplane AHBP12M1-5A

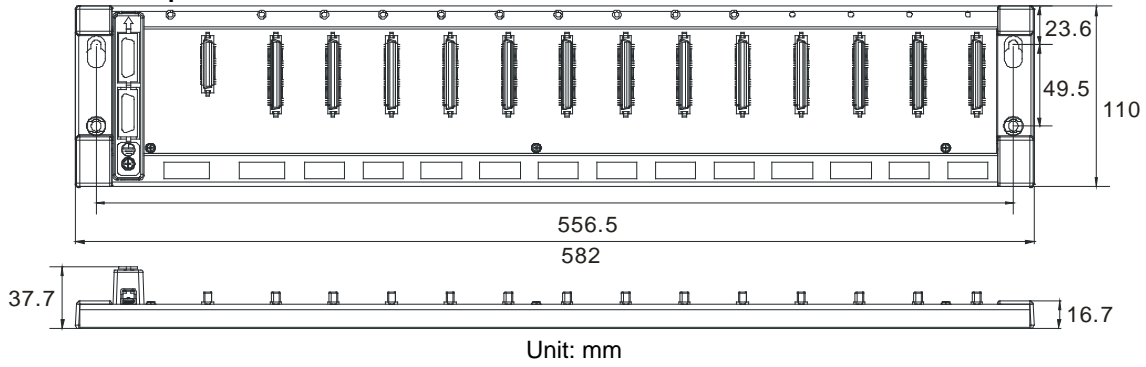

■ Extension backplane AHBP06E1-5A

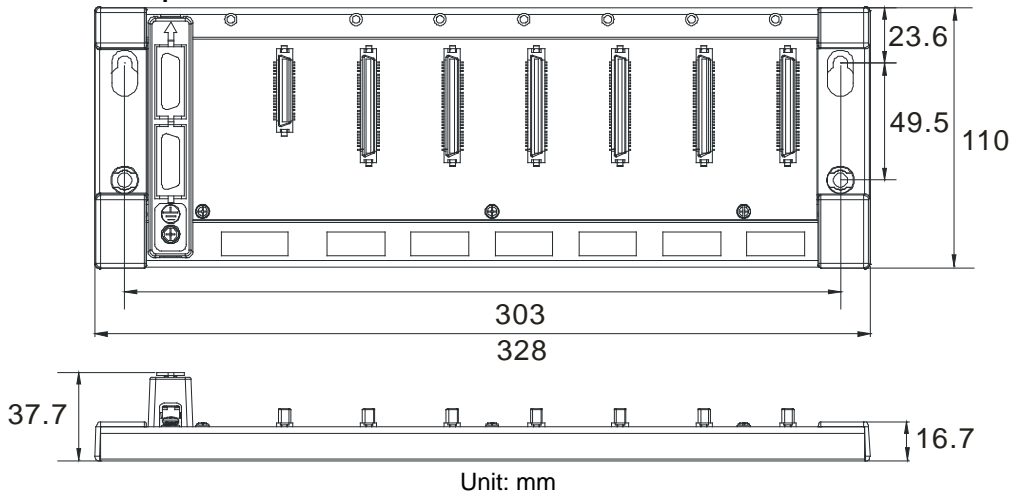

■ Extension backplane AHBP08E1-5A

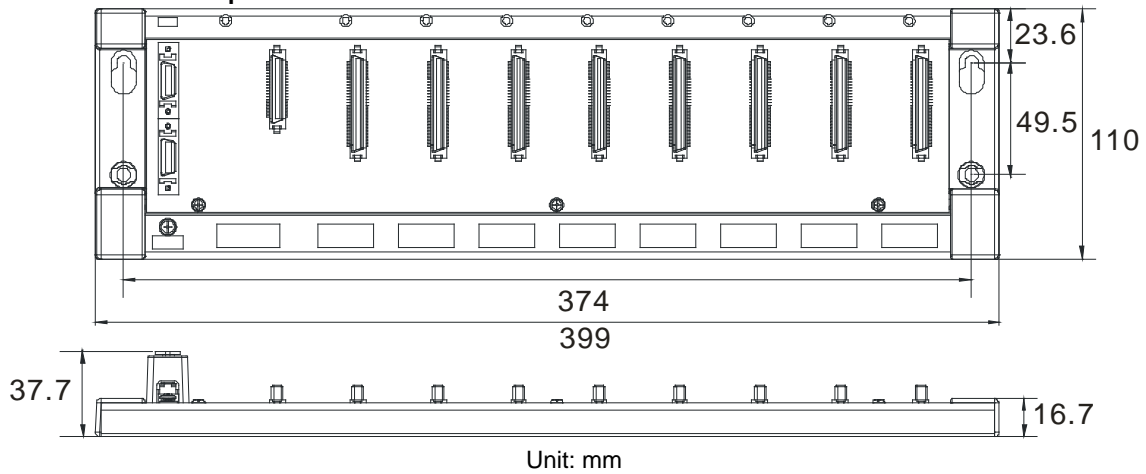

■ Extension cable



Extension cable	Length
AHACAB06-5A	0.6 m
AHACAB10-5A	1.0 m
AHACAB15-5A	1.5 m
AHACAB30-5A	3.0 m

■ AHAADP01EF-5A/AHAADP02EF-5A

AHAADP02EF-5A

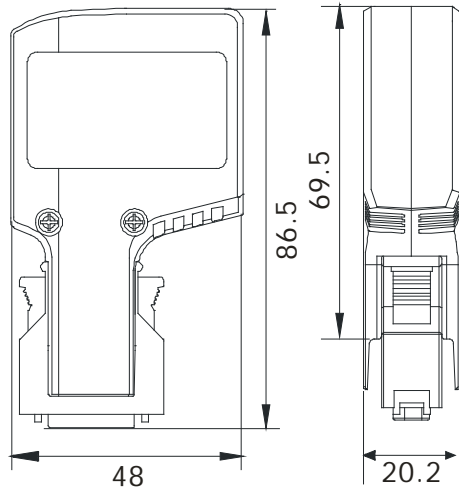

AHAADP01EF-5A

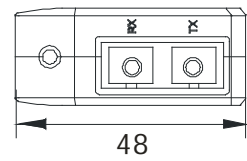
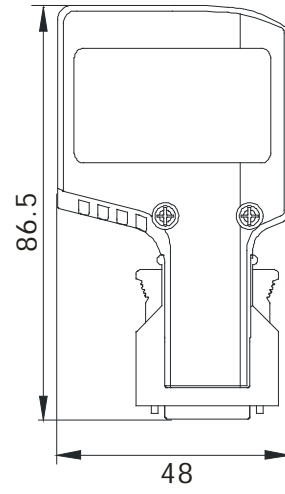

AHAADP01EF-5A

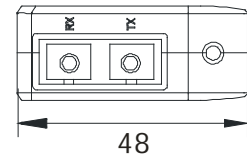

AHAADP02EF-5A

Unit: mm

MEMO



3

Chapter 3 Installing Software

Table of Contents

3.1	Installing and Uninstalling ISPSOft	3-2
3.1.1	Installing ISPSOft.....	3-2
3.1.2	Uninstalling ISPSOft	3-6
3.2	Installing and Uninstalling COMMGR.....	3-7
3.2.1	Installing COMMGR	3-7
3.2.2	Uninstalling COMMGR	3-9

Before developing an AH500 system, users need to install ISPSOft and COMMGR, which are basic software. ISPSOft is a platform for integrating the program development of a whole system, hardware configuration, and network configuration. COMMGR functions as middleware between a computer and devices. For example, it functions as a communication management interface between ISPSOft and AH500 series hardware.

3.1 Installing and Uninstalling ISPSOft

- System requirements

Item	System requirement	
Operating system	Windows 2000/NT/Me/XP/Vista/7	
CPU	Pentium 1.5 G or above	
Memory	256 MB or above (A memory having a capacity of 512 MB or above is recommended.)	
Hard disk drive	Capacity : 500 MB or above	
CD-ROM drive	For installing ISPSOft It is optionally required.	
Monitor	Resolution: 800x600 or above (Setting which is suggested: 1024x768/96 dpi)	
Keyboard/Mouse	A general keyboard/mouse, or devices compatible with Windows	
Printer	A printer with a driver for Windows (It is used to print a project, and is optionally required.)	
RS-232 port	For connecting to a PLC	One of them is used, but a PLC which is connected must have a corresponding port. (*1)
USB port	For connecting to a PLC	
Ethernet port	For connecting to a PLC	
Communication software	COMMGR, a communication manager, must be installed on a computer. (*2)	
Models which are supported	AH500 series PLCs/DVP series PLCs (exclusive of DVP-PM series PLCs)/VFD-C2000 series AC motor drives/VFD-C200 series AC motor drives/VFD-CP2000 AC motor drives /VFD-E AC motor drives (*3)	

*1. ISPSOft supports several ways in which a computer is connected to a PLC. Users have to make sure of the port and the mode supported by a PLC before a computer is connected to the PLC.

*2. Please refer to section 1.2 for more information about COMMGR.

*3. In addition to ISPSOft, users must use PMSOft version 2.05 or above to develop AH10PM-5A and AH20MC-5A.

*4. The functions and specifications mentioned above are only applicable to ISPSOft version 2.00 or above. The older versions are not equipped with the complete functions.

3.1.1 Installing ISPSOft

If an older version of ISPSOft has been installed on a computer, users have to uninstall it before install ISPSOft. Please refer to section 3.1.2 for more information about uninstalling ISPSOft. The following are the steps of installing ISPSOft.

- (1) Start the Windows 2000/NT/Me/XP/Vista/7 operating system.
- (2) Put the ISPSOft CD in the CD-ROM drive, or download the installation program from <http://www.delta.com.tw/ch/index.asp>. (Before the installation program downloaded from the website is installed, it has to be decompressed.)

- (3) Click **Start**, and then click **Run...** to open the **Run** window. Specify a path which denotes a file called **setup.exe** in the **Open** box, and then click **OK**. Users can also double-click the **setup** icon to execute the installation program.

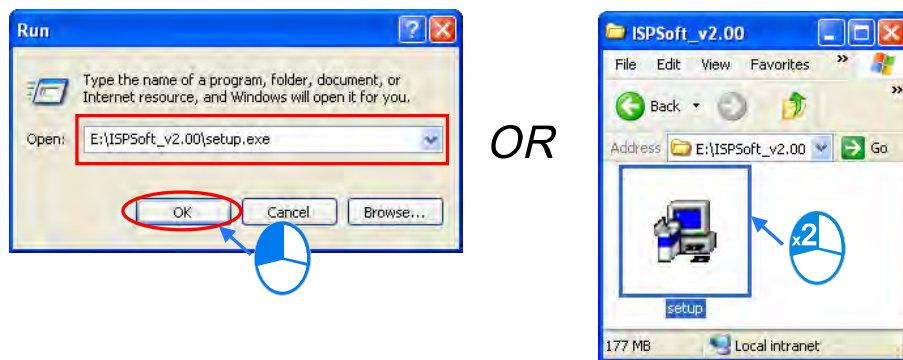

- (4) After the **ISPSoft x.xx – InstallShield Wizard** window appears, click **Next**.

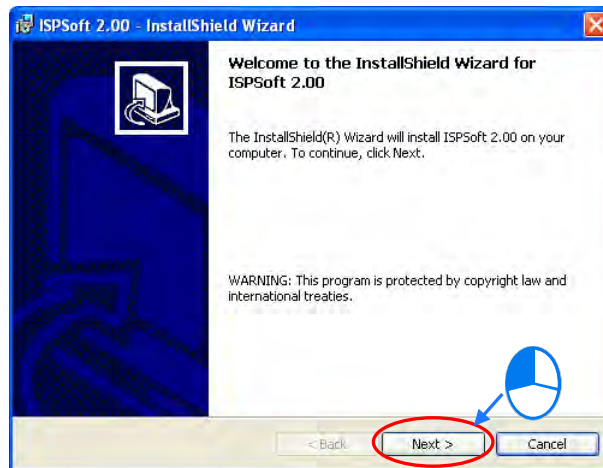

- (5) Type related information in the **User Name** box and **Organization** box, and then click **Next**.

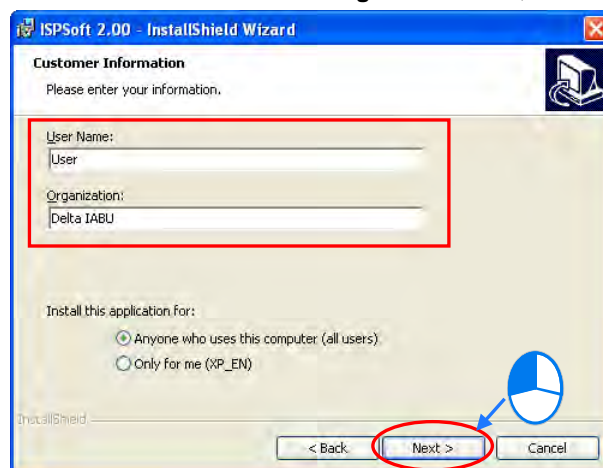

- (6) Leave the default path unchanged, or click **Change...** to change the path. Click **Next** to proceed to the next step.

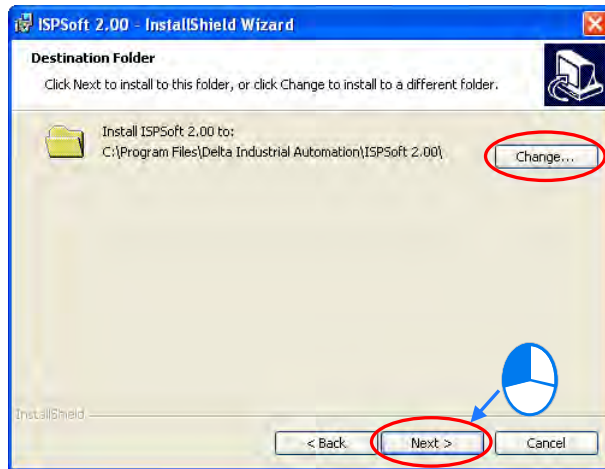

- (7) Check the installation information, and then click **Install**.

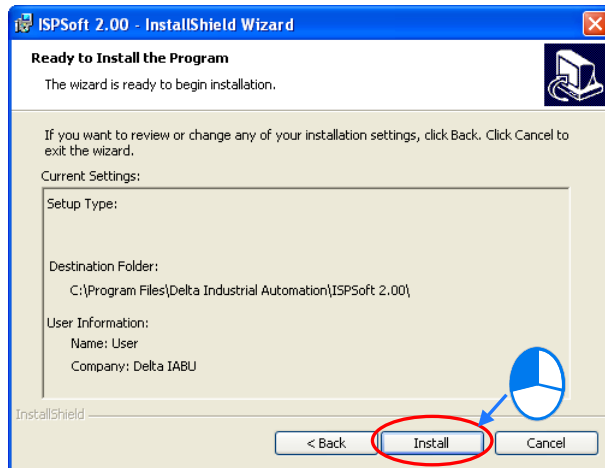

- (8) After ISPSOft is installed, shortcuts to the program are created on the desktop and the **Start** menu. Click **Finish** to complete the installation.

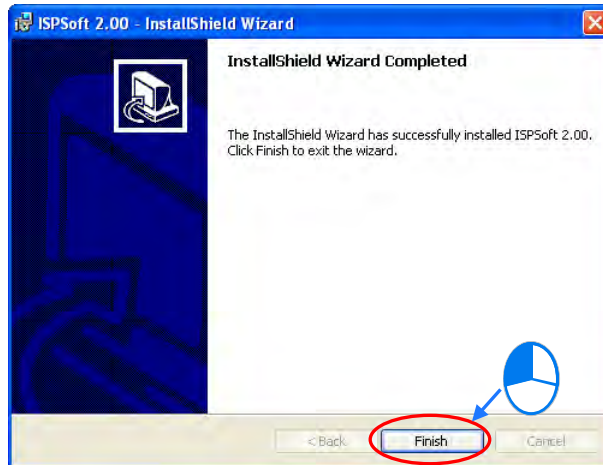
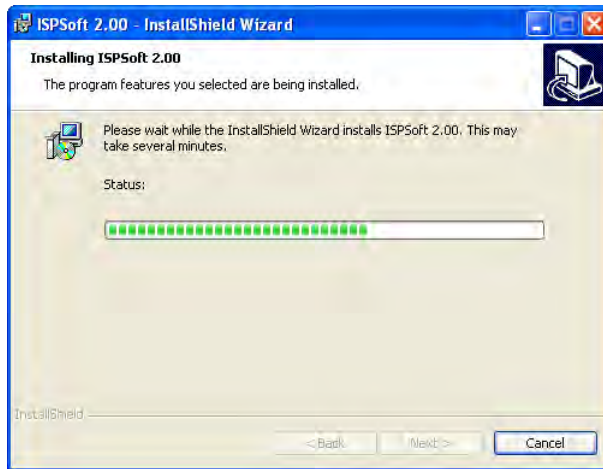

3

3.1.2 Uninstalling ISPSOft

(1) There are two methods of uninstalling ISPSOft.

- Method 1: Open the **Control Panel** window, and click **Add or Remove Programs**. In the **Currently installed programs** box, click **ISPSOft x.xx**, and then click **Remove**.

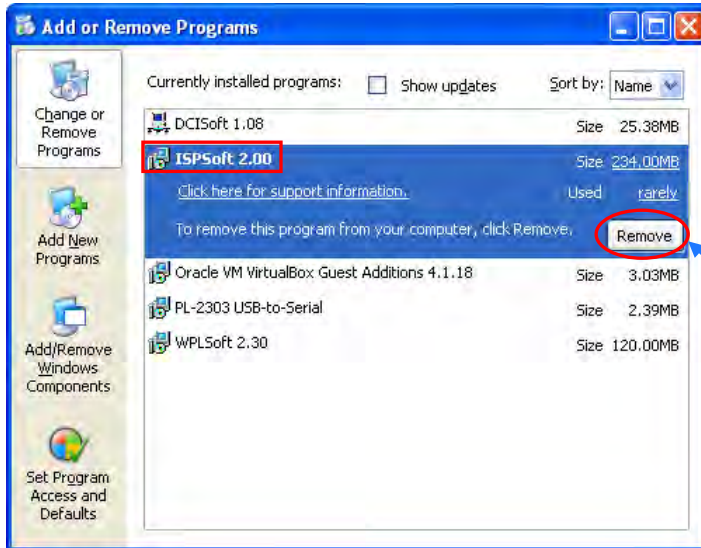

- Method 2: **Start>Programs>Delta Industrial Automation>PLC>ISPSOft x.xx>Uninstall**

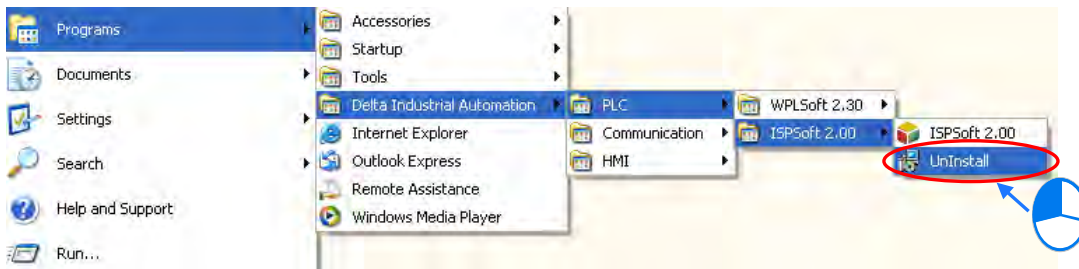

(2) After users click **Yes**, ISPSOft will be removed.

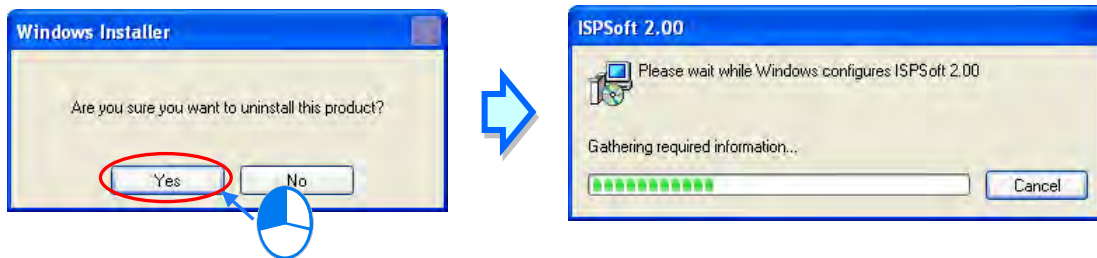

3.2 Installing and Uninstalling COMMGR

3.2.1 Installing COMMGR

If an older version of COMMGR has been installed on a computer, users have to uninstall it before install COMMGR. Please refer to section 3.2.2 for more information about uninstalling COMMGR. The following are the steps of installing COMMGR.

- (1) Start the Windows 2000/NT/Me/XP/Vista/7 operating system.
- (2) Put a COMMGR CD in the CD-ROM drive, or download the installation program from <http://www.delta.com.tw/ch/index.asp>. (Before the installation program downloaded from the website is installed, it has to be decompressed.)
- (3) Click **Start**, and then click **Run...** to open the **Run** window. Specify a path which denotes a file called **setupComm.exe** in the **Open** box, and then click **OK**. Users can also double-click the **setupComm** icon to execute the installation program.

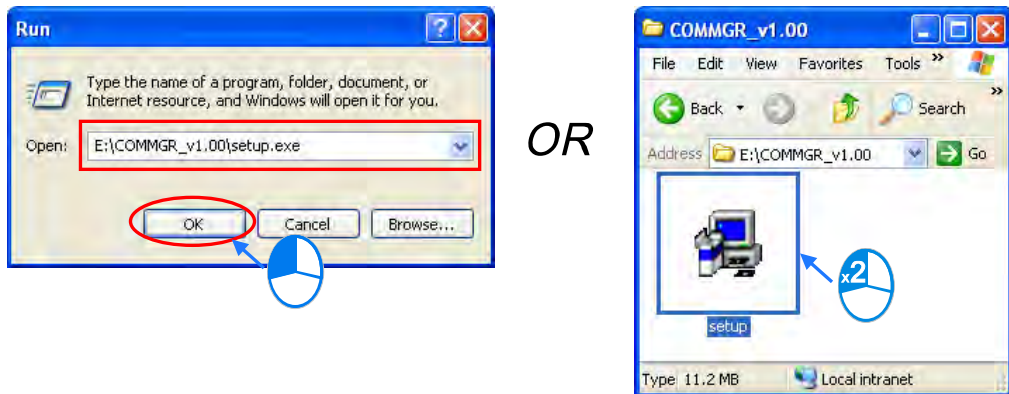

- (4) After the **COMMGR x.xx – InstallShield Wizard** window appears, click **Next**.

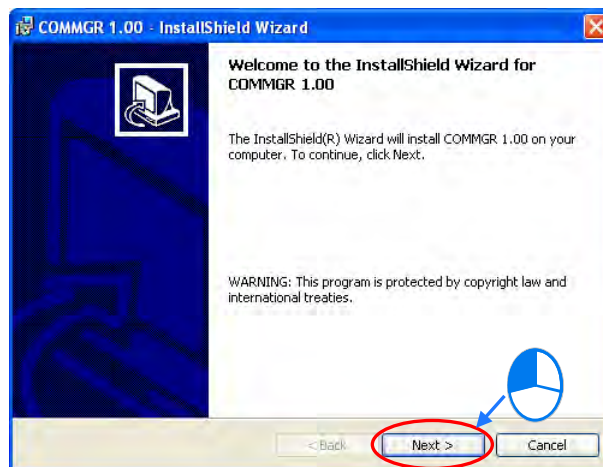
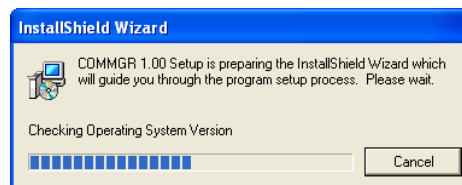

(5) Type information in the **User Name** box and the **Organization** box, and then click **Next**.

3

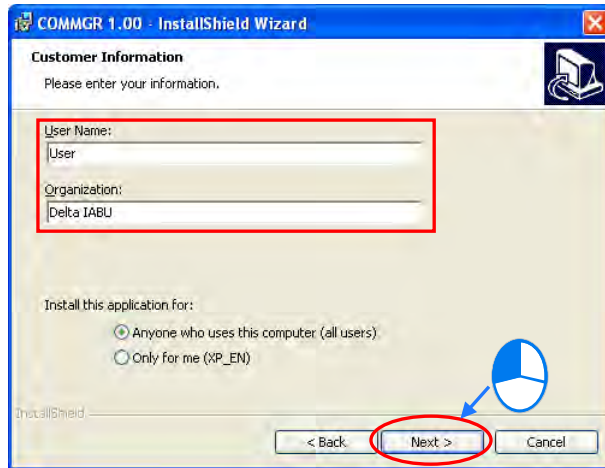

(6) Check the installation information, and then click **Install**.

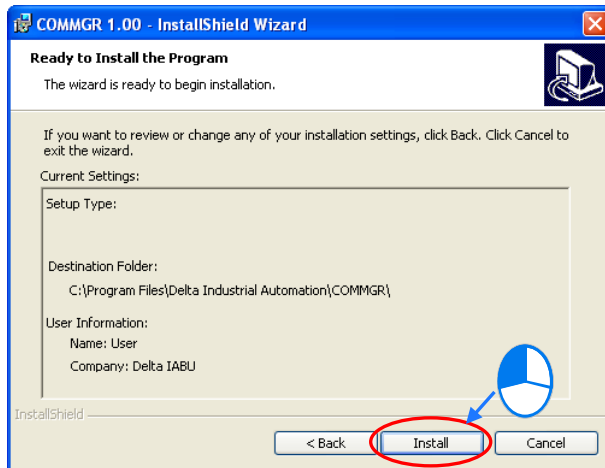

(7) After COMMGR is installed, a shortcut to the program is created on the **Start** menu. Click **Finish** to complete the installation.

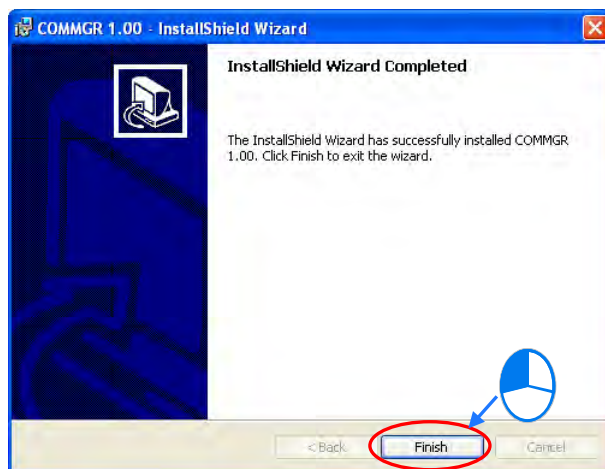

3.2.2 Uninstalling COMMGR

(1) There are two methods of uninstalling COMMGR.

- Method 1: Open the **Control Panel** window, and click **Add or Remove Programs**. In the **Currently installed programs** box, click **COMMGR x.xx**, and then click **Remove**.

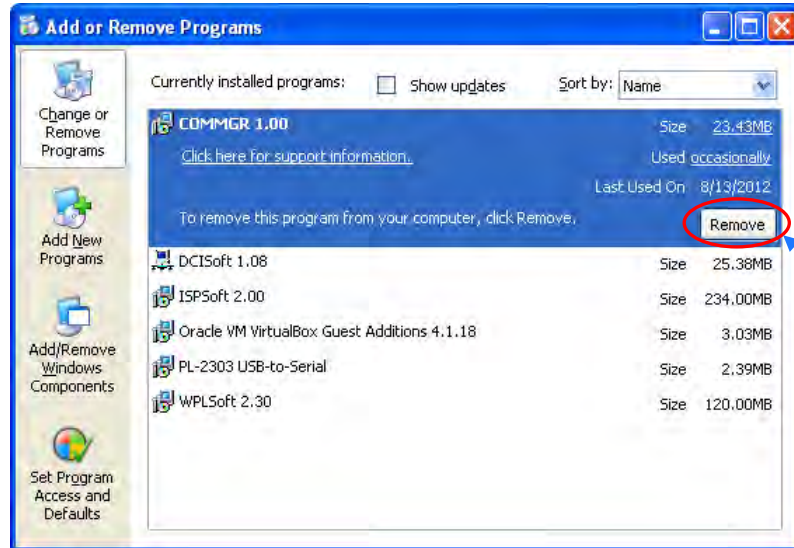

- Method 2: **Start>Programs>Delta Industrial Automation>Communication>COMMGR>Uninstall**

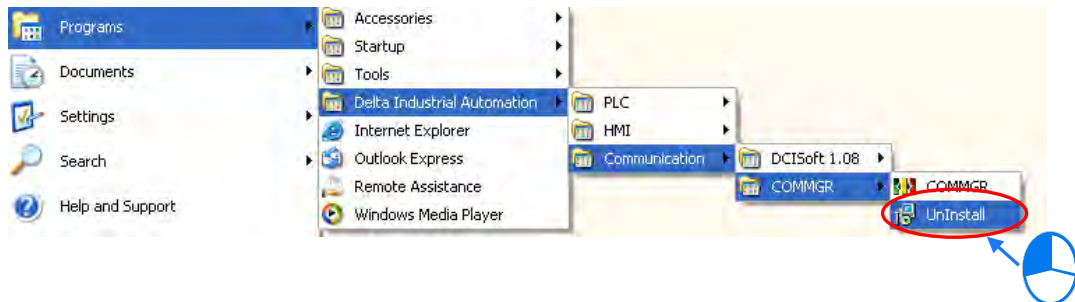

(2) After users click **Yes**, COMMGR will be removed.



MEMO

3

4

Chapter 4 Installing Hardware

Table of Contents

4.1	Installation	4-2
4.1.1	Mounting a Backplane.....	4-2
4.1.2	Installing a Module	4-4
4.2	Wiring	4-5
4.2.1	Wiring a Power Supply Module	4-5
4.2.2	Wiring I/O Modules.....	4-7

4.1 Installation

4.1.1 Mounting a Backplane

- **Fixing a backplane by screws**

Please mount a backplane on a plane by means of M5 screws, as illustrated below. To fix the backplane, users need to judge the length of a screw, the size of a thread, and whether to use a nut according to the actual condition of the plane unless there are specific specifications for a screw which are indicated in the pictures below.

1. Tighten the M5 screws in the holes indicated by **a**.

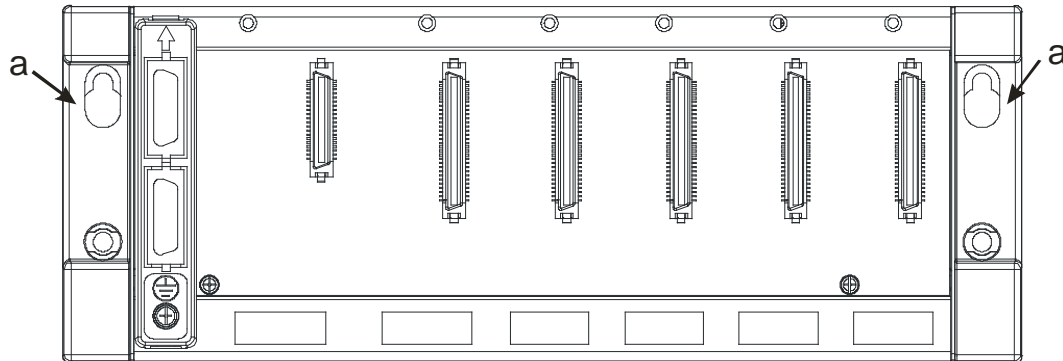

2. Tighten the two screws in the holes indicated by **b**.

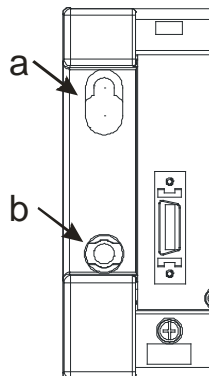

- **Installing a DIN Rail**

1. The installation is applicable to a 35 millimeter DIN rail.
2. Install the mounting clips on a backplane.

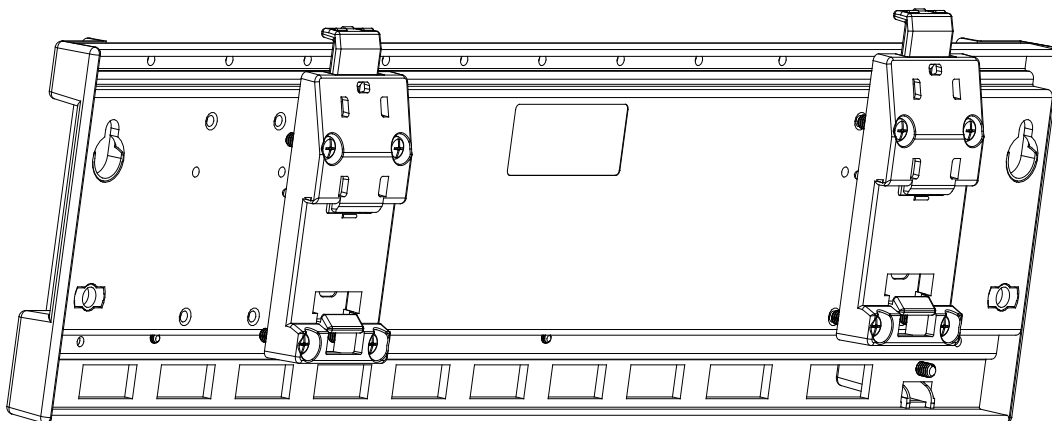

4

3. Install the backplane on a DIN rail.
Step 1: Pull the clasp in the direction indicated by the arrow.
Step 2: Hang the backplane on a DIN rail.
Step 3: Press the clasp.

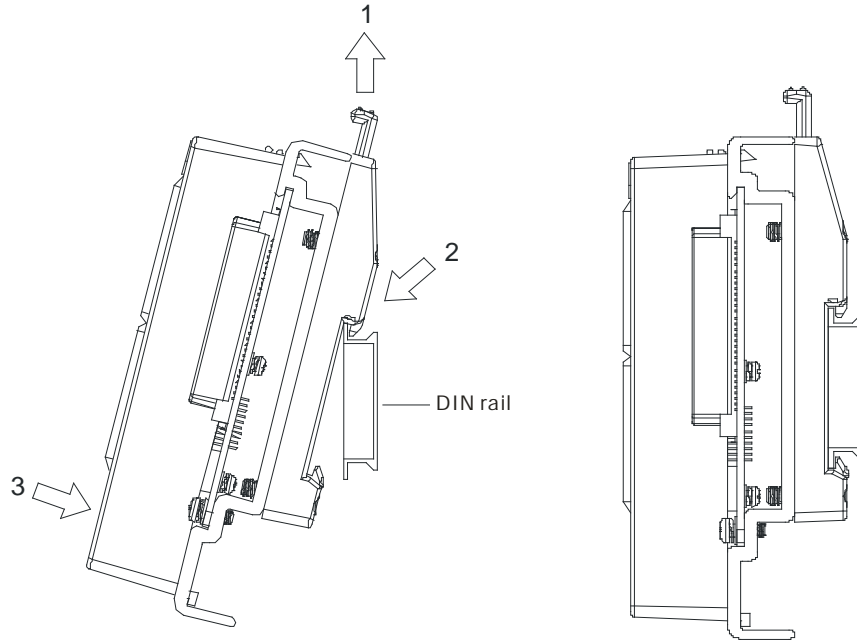

● **Removing a DIN rail**

- Step 1: Press the clasp in the direction indicated by the arrow.
- Step 2: Remove the backplane.

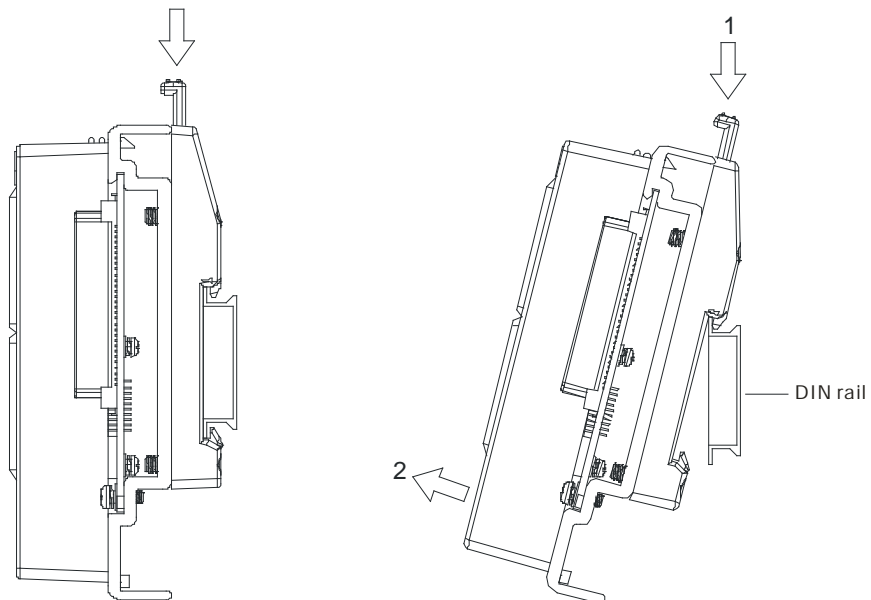

4.1.2 Installing a Module

Prepare modules which will be used, e.g. a power supply module, a CPU module, and digital I/O modules, and etc. Please follow the steps of installing a module illustrated in chapter 2 in AH500 Hardware Manual. Insert a module into a slot, make sure that the module is installed on the backplane properly, and tighten the the screw, as illustrated below.

1. Insert the projection under the module into the hole in the backplane.
2. Push the module in the direction indicated by the arrow until it clicks.

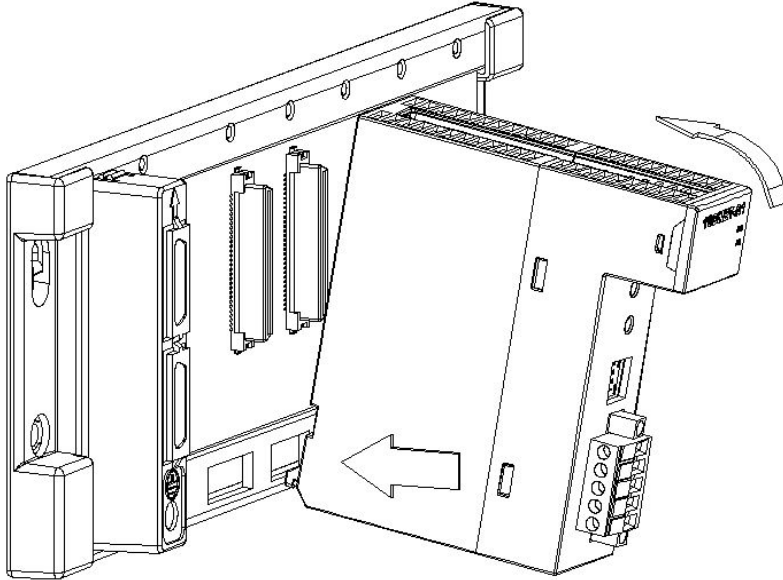

3. Tighten the screw on the module.

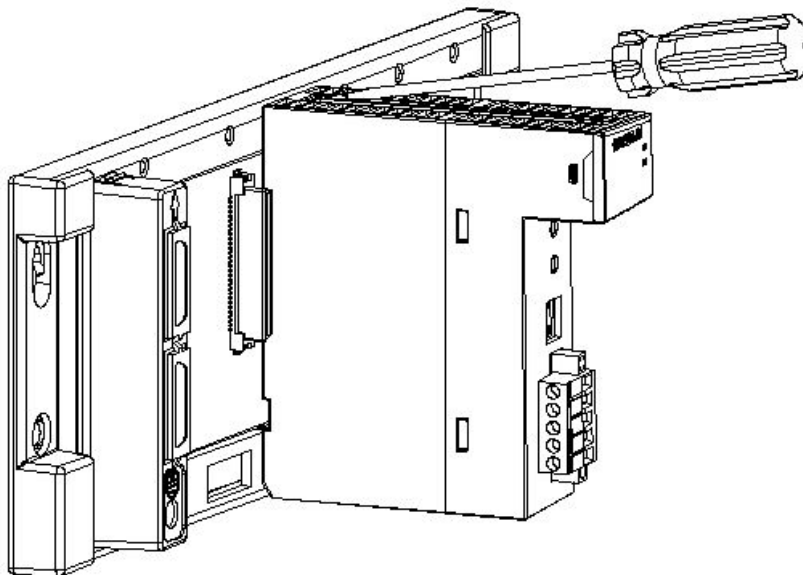

4.2 Wiring

4.2.1 Wiring a Power Supply Module

There is one power supply module installed on every backplane. A power supply module supplies direct current to a CPU module and I/O modules. Please follow the directions for the wiring of a power supply module in chapter 5 in AH500 Hardware Manual.

- **Connecting an AC power cable**

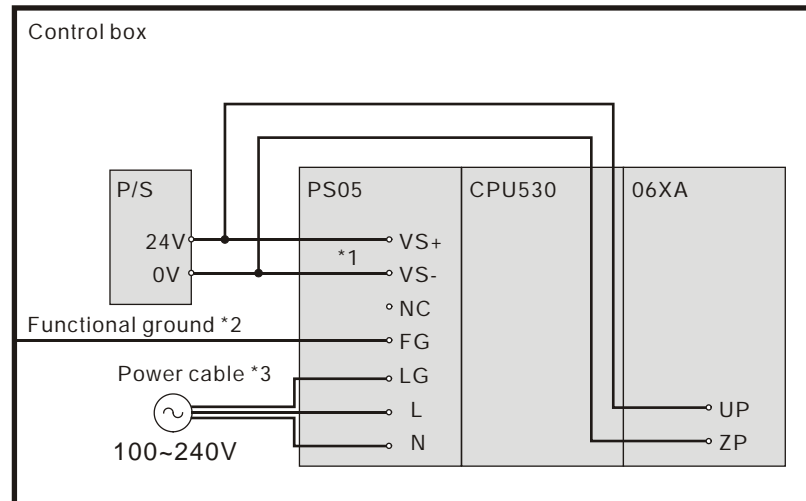

- *1. 24V on the external power supply is connected to VS+ and VS- on the power supply module. VS+ and VS- can be used to detect whether the voltage of the external power supply is stable.
- *2. FG on the power supply module is connected to the control box as the functional ground.
- *3. The live wire and the neutral wire in the AC power cable are connected to L and N on the power supply module respectively. To prevent the system from becoming abnormal, the ground in the AC power cable has to be connected to LG on the power supply module.

The power input of AHPS05-5A is the AC input. Users have to pay attention to the following points when they use AHPS05-5A.

- The alternating-current input voltage is in the range of 100 VAC to 240 VAC. Please connect the power supply to the terminals L and N. If the 110 VAC or the 220 VAC power supply is connected to the input terminals VS+ and VS-, the PLC will be damaged.
- In order to ensure that the external power supply stably provides 24 VDC power, the external power supply can be connected to VS+ and VS-. If the PLC detects that the voltage of the external power supply is lower than the working voltage, users can write a protective program.
- The length of the cable connecting with the ground should be more than 1.6 millimeters.
- If the power cut lasts for less than 10 milliseconds, the PLC keeps running without being affected. If the power cut lasts for long, or if the voltage of the power supply decreases, the PLC stops running, and there is no output. When the power supply returns to normal, the PLC resumes. (Users have to notice that there are latched auxiliary relays and registers in the PLC when they write the program.)
- Please use single-core cables or multicore cables. The diameters of the cables used should be in the range of 12 AWG to 22 AWG. The torque applied to the terminal screws should be 9.50 kg-cm (8.25 lb-in). Please use copper conducting wires. The temperature of the copper conductive cables should be 60/75°C.
- Safety wiring: The PLC controls many devices, and the activity of any device affects the activity of other devices. If any device breaks down, the whole automatic control system goes out of control, and the danger occurs. The protection circuit is as follows.

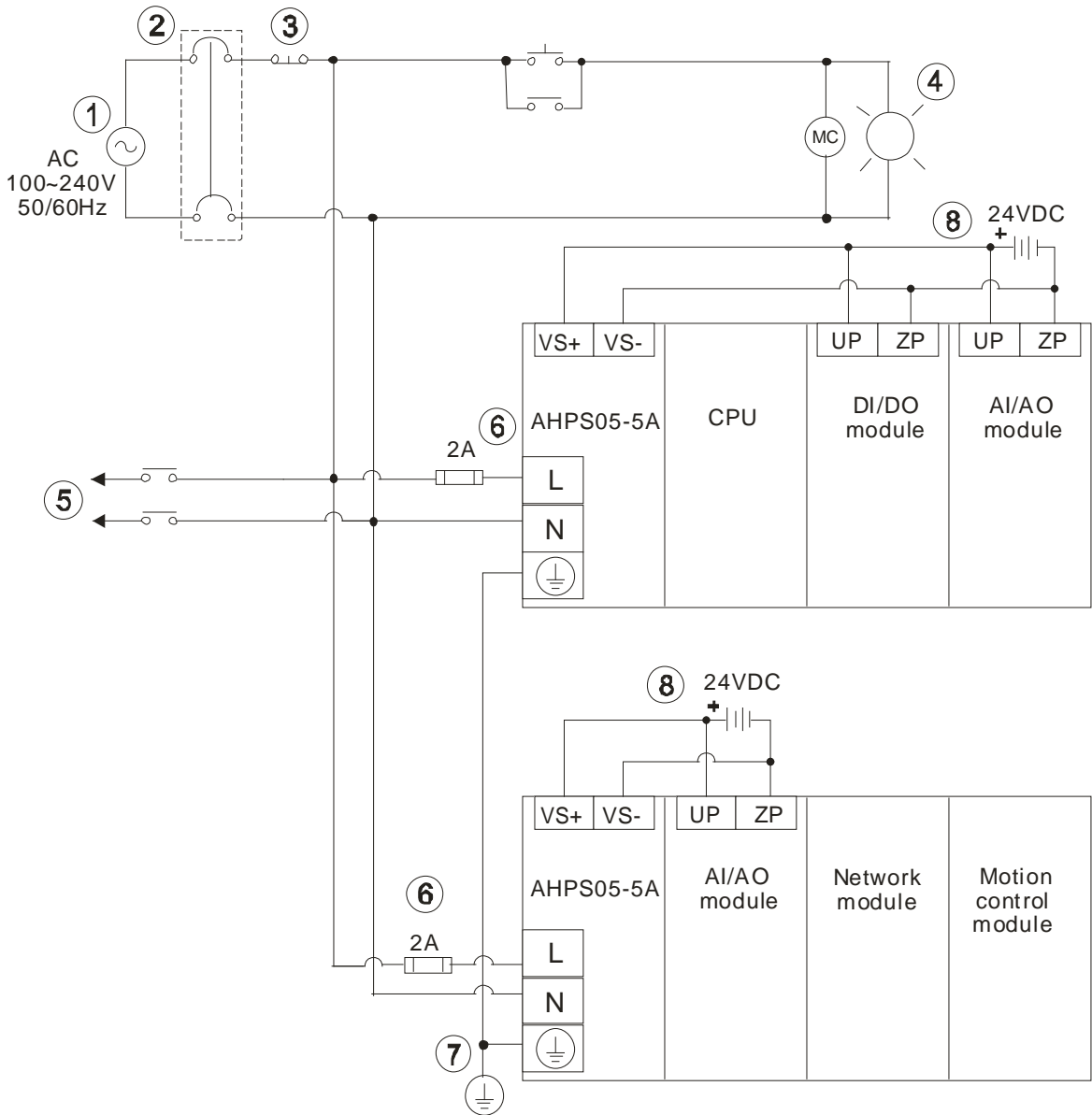

4

①	Alternating-current power supply: 100~240 VAC, and 50/60 Hz
②	Circuit breaker
③	Emergency stop: The emergency stop button can be used to cut off the power when an emergency occurs.
④	Power indicator
⑤	Load through which the alternating current passes
⑥	2 A fuse
⑦	The ground impedance is less than 100 Ω.
⑧	Direct-current power supply: 24 VDC

- **Connecting a DC power cable**

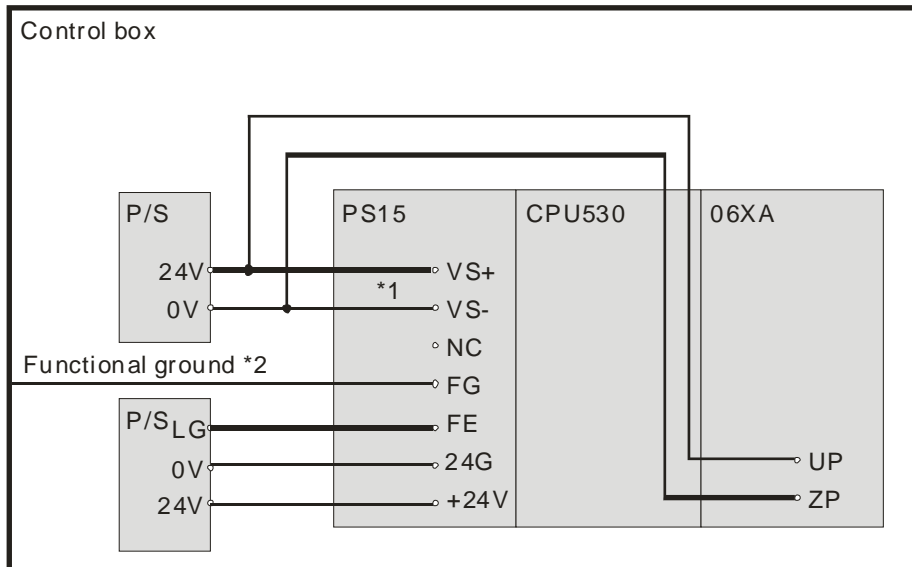

*1. 24V on the external power supply is connected to VS+ and VS- on the power supply module. VS+ and VS- can be used to detect whether the voltage of the external power supply is stable.

*2. FG on the power supply module is connected to the control box as the functional ground.

*3. +24V and 24G on the power supply module are connected to 24V and 0V on the DC power supply. To prevent the system from becoming abnormal, the ground of the DC power supply has to be connected to FE on the power supply module.

The power input of AHPS15-5A is the DC input. Users have to pay attention to the following points when they use AHPS15-5A.

- In order to ensure that the external power supply stably provides 24 VDC power, the external power supply can be connected to VS+ and VS-. If the PLC detects that the voltage of the external power supply is lower than the working voltage, users can write a protective program.
- The length of the cable connecting with the ground should be more than 1.6 millimeters.
- If the power cut lasts for less than 10 milliseconds, the PLC keeps running without being affected. If the power cut lasts for long, or if the voltage of the power supply decreases, the PLC stops running, and there is no output. When the power supply returns to normal, the PLC resumes. (Users have to notice that there are latched auxiliary relays and registers in the PLC when they write the program.)
- Please use single-core cables or multicore cables. The diameters of the cables used should be in the range of 12 AWG to 22 AWG. The torque applied to the terminal screws should be 9.50 kg-cm (8.25 lb-in). Please use copper conducting wires. The temperature of the copper conductive cables should be 60/75°C.

4.2.2 Wiring I/O Modules

The I/O modules include digital input/output modules, analog input/output modules, and network module. Please follow the directions for the wiring of I/O modules in chapter 5 in AH500 Hardware Manual.

5

Chapter 5 Devices

Table of Contents

5.1 Introduction of Devices	5-2
5.1.1 Devise Table	5-2
5.1.2 Basic Structure of I/O Storages	5-4
5.1.3 Relation Between the PLC Action and the Device Type.....	5-4
5.1.4 Latched Areas in the Device Range	5-5
5.2 Functions of Devices	5-6
5.2.1 Values and Constants.....	5-6
5.2.2 Floating-point Numbers	5-7
5.2.3 Strings.....	5-7
5.2.4 Input Relays.....	5-7
5.2.5 Output Relays	5-7
5.2.6 Auxiliary Relays	5-7
5.2.7 Special Auxiliary Relays	5-8
5.2.8 Stepping Relays.....	5-8
5.2.9 Timers.....	5-8
5.2.10 Counters	5-9
5.2.11 32-bit Counters.....	5-9
5.2.12 Data Registers	5-10
5.2.13 Special Data Registers	5-10
5.2.14 Link Registers	5-10
5.2.15 Index Registers	5-10

5.1 Introduction of Devices

This section gives an account of values/strings processed by the PLC. It also describes the functions of devices which include input/output/auxiliary relays, timers, counters, and data registers.

5.1.1 Devise Table

5.1.1.1 AH500 basic series CPU Modules (AHCPU500/510/520/530)

Type	Device name		Number of devices	Range
Bit device	Input relay	X	1024 (AHCPU500)	X0.0~X63.15
			2048 (AHCPU510)	X0.0~X127.15
			4096 (AHCPU520)	X0.0~X255.15
			8192 (AHCPU530)	X0.0~X511.15
	Output relay	Y	1024 (AHCPU500)	Y0.0~X63.15
			2048 (AHCPU510)	Y0.0~X127.15
			4096 (AHCPU520)	Y0.0~X255.15
			8192 (AHCPU530)	Y0.0~Y511.15
	Data register	D	16384 (AHCPU500)	D0.0~D16383.15
			32768 (AHCPU510)	D0.0~D32767.15
			65536 (AHCPU520/530)	D0.0~D65535.15
	Link register	L	16384 (AHCPU500)	L0.0~D16383.15
			32768 (AHCPU510)	L0.0~D32767.15
			65536 (AHCPU520/530)	L0.0~D65535.15
Auxiliary relay	M	8192	M0~M8191	
Special auxiliary relay	SM	2048	SM0~SM2047	
Stepping relay	S	2048	S0~S2047	
Timer	T	2048	T0~T2047	
Counter	C	2048	C0~C2047	
32-bit counter	HC	64	HC0~HC63	
Word device	Input relay	X	512	X0~X511
	Output relay	Y	512	Y0~Y511
	Data register	D	16384 (AHCPU500)	D0~D16383
			32768 (AHCPU510)	D0~D32767
			65536 (AHCPU520/530)	D0~D65535
	Special data register	SR	2048	SR0~SR2047
	Link register	L	16384 (AHCPU500)	L0~D16383
			32768 (AHCPU510)	L0~D32767
			65536 (AHCPU520/530)	L0~D65535
	Timer	T	2048	T0~T2047
Counter	C	2048	C0~C2047	
32-bit counter	HC	64 (128 words)	HC0~HC63	
Index register	E	32	E0~E31	
Constant*	Decimal system	K	16 bits: -32768~32767 32 bits: -2147483648~2147483647	
	Hexadecimal system	16#	16 bits: 16#0~16#FFFF 32 bits: 16#0~16#FFFFFFFF	
	Single-precision floating-point number	F	32 bits: $\pm 1.17549435^{-38} \sim \pm 3.40282347^{+38}$	
	Double-precision floating-point number	DF	64 bits: $\pm 2.2250738585072014^{-308} \sim \pm 1.7976931348623157^{+308}$	
String*	String	"\$"	1~31 characters	

*1: The decimal forms are notated by K in the device lists in Chapter 5 and Chapter 6 in AH500 Programming Manual, whereas K50 should be inputted in ISPSOft rather than merely 50.

*2: The floating-point numbers are notated by F/DF in the device lists in Chapter 5 and Chapter 6 in AH500

Programming Manual, whereas they are represented by decimal points in ISPSOft; for the floating-point F500, one should input 500.0.

*3: The strings are notated by "\$" in Chapter 5 and Chapter 6 in AH500 Programming Manual, whereas they are represented by "" in ISPSOft; for the string of 1234, one should input "1234" in ISPSOft.

5.1.1.2 AH500 advanced series CPU Modules (AHCPU511/521/531)

Type	Device name		Number of devices	Range
Bit device	Input relay	X	4096 (AHCPU511)	X0.0~X255.15
			8192 (AHCPU521)	X0.0~X511.15
			16384 (AHCPU531)	X0.0~X1023.15
	Output relay	Y	4096 (AHCPU511)	Y0.0~Y255.15
			8192 (AHCPU521)	Y0.0~Y511.15
			16384 (AHCPU531)	Y0.0~Y1023.15
	Data register	D	786432 (AHCPU511)	D0.0~D49151.15
			1572864 (AHCPU521)	D0.0~D98303.15
			2097152 (AHCPU531)	D0.0~D131071.15
	Link register	L	786432 (AHCPU511)	L0.0~L49151.15
			1572864 (AHCPU521)	L0.0~L98303.15
			2097152 (AHCPU531)	L0.0~L131071.15
	Auxiliary relay	M	8192	M0~M8191
Special auxiliary relay	SM	2048 (AHCPU511/521/531-EN)	SM0~SM2047	
		4096 (AHCPU511-RS2)	SM0~SM4095	
Stepping relay	S	2048	S0~S2047	
Timer	T	2048	T0~T2047	
Counter	C	2048	C0~C2047	
32-bit counter	HC	64	HC0~HC63	
Word device	Input relay	X	256 (AHCPU511)	X0~X255
			512 (AHCPU521)	X0~X511
			1024 (AHCPU531)	X0~X1023
	Output relay	Y	256 (AHCPU511)	Y0~Y255
			512 (AHCPU521)	Y0~Y511
			1024 (AHCPU531)	Y0~Y1023
	Data register	D	49152 (AHCPU511)	D0~D49151
			98304 (AHCPU521)	D0~D98303
			131072 (AHCPU531)	D0~D131071
	Special data register	SR	2048 (AHCPU511/521/531-EN)	SR0~SR2047
			4096 (AHCPU511-RS2)	SR0~SR4095
	Link register	L	49152 (AHCPU511)	L0~L49151
			98304 (AHCPU521)	L0~L98303
131072 (AHCPU531)			L0~L131071	
Timer	T	2048	T0~T2047	
Counter	C	2048	C0~C2047	
32-bit counter	HC	64 (128 words)	HC0~HC63	
Index register	E	32	E0~E31	
Constant*	Decimal system	K	16 bits: -32768~32767 32 bits: -2147483648~2147483647	
	Hexadecimal system	16#	16 bits: 16#0~16#FFFF 32 bits: 16#0~16#FFFFFFFF	
	Single-precision floating-point number	F	32 bits: $\pm 1.17549435^{-38} \sim \pm 3.40282347^{+38}$	
	Double-precision floating-point number	DF	64 bits: $\pm 2.2250738585072014^{-308} \sim \pm 1.7976931348623157^{+308}$	
String*	String	"\$"	1~31 characters	

- *1: The decimal forms are notated by K in the device lists in Chapter 5 and Chapter 6 in AH500 Programming Manual, whereas K50 should be inputted in ISPSOft rather than merely 50.
- *2: The floating-point numbers are notated by F/DF in the device lists in Chapter 5 and Chapter 6 in AH500 Programming Manual, whereas they are represented by decimal points in ISPSOft; for the floating-point F500, one should input 500.0.
- *3: The strings are notated by "\$" in Chapter 5 and Chapter 6 in AH500 Programming Manual, whereas they are represented by "" in ISPSOft; for the string of 1234, one should input "1234" in ISPSOft.

5.1.2 Basic Structure of I/O Storages

Device	Function	Access of bits	Access of words	Modification by ISPSOft	Forcing the bit ON/OFF
X	Input relay	OK	OK	OK	OK
Y	Output relay	OK	OK	OK	OK
M	Auxiliary relay	OK	-	OK	NO
SM	Special auxiliary relay	OK	-	OK	NO
S	stepping relay	OK	-	OK	NO
T	Timer	OK	OK	OK	NO
C	Counter	OK	OK	OK	NO
HC	32-bit counter	OK	OK	OK	NO
D	Data register	OK	OK	OK	NO
SR	Special data register	-	OK	OK	NO
L	Link register	OK	OK	OK	NO
E	Index register	-	OK	OK	NO



5.1.3 Relation Between the PLC Action and the Device Type

PLC action		Device type	Non-latched area	Latched area	Output relay
Power: OFF→ON			Cleared	Retained	Cleared
STOP ↓ RUN	The output relay is cleared.		Retained	Retained	Cleared
	The state of the output relay is retained.		Retained	Retained	Retained
	The state of the output relay returns to that before the PLC's stopping.		Retained	Retained	Refer to the settings of device Y
	The non-latched area is cleared.		Cleared	Retained	Refer to the settings of device Y
	The state of the latched area is retained.		Retained	Retained	Retained
RUN→STOP			Retained	Retained	Retained
SM204 is ON. (All non-latched areas are cleared.)			Cleared	Retained	Cleared
SM205 is ON. (All latched areas are cleared.)			Retained	Cleared	Retained
Default value			0	0	0

5.1.4 Latched Areas in the Device Range

Device	Function	Device range	Latched area
X	Input relay	X0~X511 (AHCPU5X0)	All devices are non-latched.
		X0~X1024 (AHCPU5X1)	
Y	Output relay	Y0~Y511 (AHCPU5X0)	All devices are non-latched.
		Y0~Y1024 (AHCPU5X1)	
M*	Auxiliary relay	M0~M8191	The default range is M0~M8191.
SM	Special auxiliary relay	SM0~SM2047 (AHCPU511-EN/ AHCPU521/AHCPU531) SM0~SM4095 (AHCPU511-RS2)	Some devices are latched, and can not be changed. Please refer to the list of special auxiliary relays for more information.
S	Stepping relay	S0~S2047	All devices are non-latched.
T*	Timer	T0~T2047	The default range is T0~T2047.
C*	Counter	C0~C2047	The default range is C0~C2047.
HC*	32-bit counter	HC0~HC63	The default range is HC0~HC63.
D*	Data register	D0~D16383 (AHCPU500)	The default range is D0~D16383.
		D0~D32767 (AHCPU510/511/521/531)	The default range is D0~D32767. At most 32768 devices can be latched areas.
		D0~D65535 (AHCPU520/ AHCPU530)	
SR	Special data register	SR0~SR2047 (AHCPU510/ AHCPU 511-EN/ AHCPU 521/ AHCPU 531) SR0~SR4095 (AHCPU511-RS2)	Some are latched, and can not be changed. Please refer to the list of special data registers for more information.
L	Link register	L0~L16383 (AHCPU500)	All devices are non-latched.
		L0~D32767 (AHCPU510)	
		L0~L49151 (AHCPU511)	
		L0~D65535 (AHCPU520/530)	
		L0~L98303 (AHCPU521)	
		L0~L131071 (AHCPU531)	
E	Index register	E0~E31	All devices are non-latched.

*: * indicates that users can set the range of latched areas, and that the device can be set to Non-latched Area. The range of latched areas can not exceed the device range. Above all, only 32768 data registers at most can be non-latched areas. For example, users can set D50~D32817 or D32768~D65535 to Latched Areas although the default range of latched areas is D0~D32767.

5.2 Functions of Devices

Procedure for processing the program in the PLC:

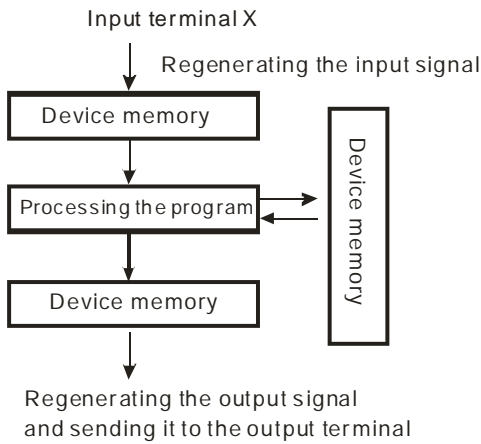

- Regenerating the input signal
 1. Before the program is executed, the state of the external input signal is read into the memory of the input signal.
 2. When program is executed, the state in the memory of the input signal does not change even if the input signal changes from ON to OFF or from OFF to ON. Not until the next scan begins will the input signal be refreshed.
- Processing the program

After the input signal is refreshed, the instructions in the program are executed in order from the start address of the program, and the results are stored in the device memories.
- Regenerating the state of the output

After the instruction END is executed, the state in the device memory is sent to the specified output terminal.

5.2.1 Values and Constants

5

Name	Description
Bit	A bit is the basic unit in the binary system. Its state is either 1 or 0.
Nibble	A nibble is composed of four consecutive bits (e.g. b3~b0). Nibbles can be used to represent 0~9 in the decimal system, or 0~F in the hexadecimal system.
Byte	A byte is composed of two consecutive nibbles (i.e. 8 bits, b7~b0). Bytes can be used to represent 00~FF in the hexadecimal system.
Word	A word is composed of two consecutive bytes (i.e. 16 bits, b15~b0). Words can be used to represent 0000~FFFF in the hexadecimal system.
Double word	A double word is composed of two consecutive words (i.e. 32 bits, b31~b0). Double words can be used to represent 00000000~FFFFFFFF in the hexadecimal system.
Quadruple word	A quadruple word is composed of four consecutive words (i.e. 64 bits, b63~b0). Quadruple words can be used to represent 0000000000000000 – FFFFFFFFFFFFFFFFFF in the hexadecimal system.

The relation among bits, nibbles, bytes, words, and double words in the binary system is shown below.

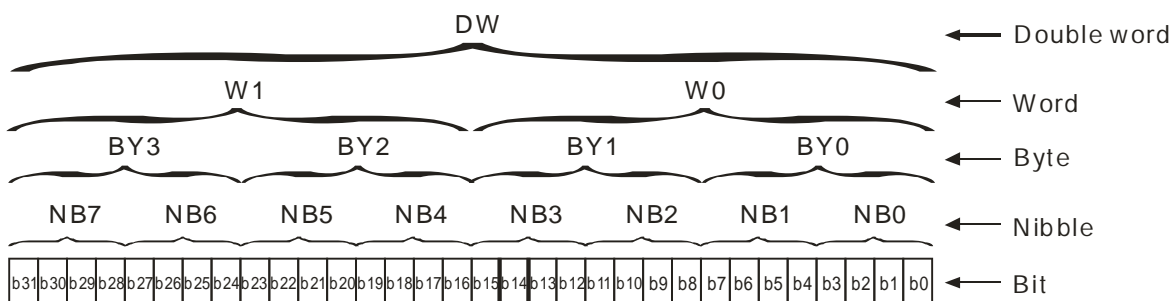

5.2.2 Floating-point Numbers

The floating-point numbers are represented by decimal points in ISPSOft. For example, the floating-point number of 500 is 500.0. Please refer to section 2.2.2 in AH500 Programming Manual for more information.

5.2.3 Strings

What strings can process are ASCII codes. A complete string begins with a start character, and ends with an ending character (NULL code). If what users enter is a string, they can enter 31 characters at most, and the ending character 16#00 will be added automatically in ISPSOft. Please refer to section 2.2.3 in AH500 Programming Manual for more information.

5.2.4 Input Relays

- Function of the input
The input is connected to the input device (e.g. external devices such as button switches, rotary switches, number switches, and etc.), and the input signal is read into the PLC. Besides, contact A or contact B of the input can be used several times in the program, and the ON/OFF state of the input varies with the ON/OFF state of the input device.
- Input number (the decimal number):
For the PLC, the input numbers start from X0.0. The number of inputs varies with the number of inputs on the digital input/output modules, and the inputs are numbered according to the order in which the digital input/output modules are connected to the CPU module. The maximum number of inputs on the PLC can reach up to 8192, and the range is between X0.0 and X511.15.
- Input type
The inputs are classified into two types.
 1. Regenerated input: Before the program is executed, the data is fed into the PLC according to the states of the inputs which are regenerated. For example, LD X0.0.
 2. Direct input: During the execution of the instructions, the data is fed into the PLC according to the states of the inputs. For example, LD DX0.0.

5

5.2.5 Output Relays

- Function of the output
The task of the output is sending the ON/OFF signal to drive the load connected to the output. The load can be an external signal lamp, a digital display, or an electromagnetic valve. There are three types of outputs. They are relays, transistors, and TRIACs (AC thyristors). Contact A or contact B of the output can be used several times in the program, but the output should be used only once in the program. Otherwise, according the program-scanning principle of the PLC, the state of the output depends on the circuit connected to the last output in the program.
- Output number (the decimal number)
For the PLC, the input numbers start from X0.0. The number of outputs varies with the number of outputs on the digital input/output modules, and the outputs are numbered according to the order in which the digital input/output modules are connected to the PLC. The maximum number of outputs on the PLC can reach up to 8192, and the range is between Y0.0 and Y511.15.
The output which is not practically put to use can be used as a general device.
- Output type
The outputs are classified into two types.
 1. Regenerated output: Not until the program executes the instruction END is the information fed out according to the states of the outputs. For example, OUT Y0.0.
 2. Direct output: When the instructions are executed, the information is fed out according to the states of the outputs. For example, OUT DY0.0.

5.2.6 Auxiliary Relays

The auxiliary relay has contact A and contact B. It can be used several times in the program. Users can combine the control loops by means of the auxiliary relay, but can not drive the external load by means of the auxiliary relay. The auxiliary relays can be divided into two types according to their attributes.

1. For general use: If an electric power cut occurs when the PLC is running, the auxiliary relay for general use will be reset to OFF. When the power supply is restored, the auxiliary relay for general use is still OFF.
2. For latched use: If an electric power cut occurs when the PLC is running, the state of the auxiliary relay for latched use will be retained. When the power supply is restored, the state remains the same as that before the power electric cut.

5.2.7 Special Auxiliary Relays

Every special auxiliary relay has its specific function. Please refer to section 2.2.7 in AH500 Programming Manual for more information.

5.2.8 Stepping Relays

Function of the stepping relay:

The stepping relay can be easily used in the industrial automation to set the procedure. It is the most basic device in the sequential function chart (SFC). Please refer to ISPSOFT User Manual for more information related to sequential function charts.

There are 2048 stepping relays, i.e. S0~S2047. Every stepping relay is like an output relay in that it has an output coil, contact A, and contact B. It can be used several times in the program, but it can not directly drive the external load. Besides, the stepping relay can be used as a general auxiliary relay when it is not used in the sequential function chart.

5.2.9 Timers



1. 100 millisecond timer: The timer specified by the instruction TMR takes 100 milliseconds as the timing unit.
2. 1 millisecond timer: The timer specified by the instruction TMRH takes 1 millisecond as the timing unit.
3. The timers for the subroutine's exclusive use are T1920~T2047.
4. The accumulative timers are ST0~ST2047. If users want to use the device-monitoring function, they can monitor T0~T2047.
5. If the same timer is used repeatedly in the program, including in different instructions TMR and TMRH, the setting value is the one that the value of the timer matches first.
6. If the same timer is used repeatedly in the program, it is OFF when one of the conditional contacts is OFF.
7. If the same timer is used repeatedly in the program as the timer for the subroutine's exclusive use and the accumulative timer in the program, it is OFF when one of the conditional contacts is OFF.
8. When the timer is switched from ON to OFF and the conditional contact is ON, the timer is reset and counts again.
9. When the instruction TMR is executed, the specified timer coil is ON and the timer begins to count. As the value of the timer matches the setting value, the state of the contact is as follows.

Normally open (NO) contact	ON
Normally closed (NC) contact	OFF

- **General-purpose timer**

When the instruction TMR is executed, the general-purpose timer begins to count. As the value of the timer matches the setting value, the output coil is ON.

- **Accumulative timer**

When the instruction TMR is executed, the accumulative timer begins to count. As the value of the timer matches the setting value, the output coil is ON. As long as users add the letter S in front of the letter T, the timer becomes the accumulative timer. When the conditional contact is OFF, the value of the accumulative timer is not reset. When the conditional contact is ON, the timer counts from the current value.

- **Timer used in the function block**

T1920~T2047 are the timers which users can use in the functional block or the interrupt.

When the instruction TMR or END is executed, the timer used in the functional block begins to count. As the value of the timer matches the setting value, the output coil is ON.

If the general-purpose timer is used in the functional block or the interrupt, and the functional is not executed, the timer can not count correctly.

5.2.10 Counters

- Characteristics of the 16-bit counter

Item	16-bit counter
Type	General type
Number	C0~C2047
Direction	Counting up
Setting value	0~32,767
Specification of the setting value	The setting value can be either the constant or the value in the data register.
Change of the current value	The counter stops counting when the value of the counter matches the setting value.
Output contact	The contact is ON when the value of the counter matches the setting value.
Reset	When the instruction RST is executed, the current value is cleared to zero, and the contact is reset of OFF.
Action of the contact	After the scan is complete, the contact acts.

- Function of the counter

Each time the input switches from OFF to ON, the value of the counter increases by one increment. When the value of the counter matches the setting value, the output coil is ON. Users can use either the decimal constant or the value in the data register as the setting value.

16-bit counter:

1. Setting range: 0~32,767 (The setting values 0 and 1 mean the same thing in that the output contact is ON when the counter counts for the first time.)
2. For the general-purpose counter, the current value of the counter is cleared when there is a power cut. If the counter is the latched one, the current value of the counter and the state of the contact before the power cut will be retained. The latched counter counts from the current value when the power supply is restored.
3. If users use the instruction MOV or ISPSofT to transmit a value bigger than the setting value to the current value register C0, the contact of the counter C0 will be ON and the current value will become the same as the setting value next time X0.1 is switched from OFF to ON.
4. Users can use either the constant or the value in the register as the setting value of the counter.
5. The setting value of the counter can be a positive or a negative. If the counter counts up from 32,767, the next current value becomes -32,768.

5

5.2.11 32-bit Counters

- Characteristics of the 32-bit counter

Item	32-bit counter
Type	General type
Number	HC0~HC63
Direction	Counting up/down
setting value	-2,147,483,648~+2,147,483,647
Specification of the setting value	The setting value can be either the constant or the value occupying two data registers.
Change of the current value	The counter keeps counting after the value of the counter matches the setting value.
Output contact	The contact is ON when the value of the addition counter matches the setting value. The contact is reset to OFF when the value of the subtraction counter matches the setting value.
Reset	When the instruction RST is executed, the current value is cleared to zero, and the contact is reset of OFF.
Action of the contact	After the scan is complete, the contact acts.

- 32-bit general-purpose addition/subtraction counter
 1. Setting range: -2,147,483,648~2,147,483,647
 2. The switch between the 32-bit general-purpose addition counters and the 32-bit general-purpose subtraction counters depends on the states of the special auxiliary relays SM621~SM684. For example, the counter HC0 is the addition counter when SM621 is OFF, whereas HC0 is the subtraction counter when SM621 is ON.
 3. Users can use either the constant or the value in the data registers as the setting value of the counter, and the setting value can be a positive or a negative. If users use the value in the data registers as the setting value of the counter, the setting value occupies two consecutive registers.
 4. For the general-purpose counter, the current value of the counter is cleared when there is a power cut. If the counter is the latched one, the current value of the counter and the state of the contact before the power cut will be retained. The latched counter counts from the current value when the power supply is restored.
 5. If the counter counts up from 2,147,483,647, the next current value becomes -2,147,483,648. If the counter counts down from -2,147,483,648, the next current value becomes 2,147,483,647.

5.2.12 Data Registers

The data register stores the 16-bit data. The highest bit represents either a positive sign or a negative sign, and the values which can be stored in the data registers range from -32,768 to +32,767. Two 16-bit registers can be combined into a 32-bit register, i.e. (D+1, D) in which the register whose number is smaller represents the low 16 bits. The highest bit represents either a positive sign or a negative sign, and the values which can be stored in the data registers range from -2,147,483,648 to +2,147,483,647. Besides, four 16-bit registers can be combined into a 64-bit register, i.e. (D+3, D+2, D+1, D) in which the register whose number is smaller represents the lower 16 bits. The highest bit represents either a positive sign or a negative sign, and the values which can be stored in the data registers range from -9,223,372,036,854,776 to +9,223,372,036,854,775,807. The data registers can also be used to refresh the values in the control registers in the modules other than digital I/O modules. Please refer to ISPSOft User Manual for more information regarding refreshing the values in the control registers.

The registers can be classified into two types according to their properties.

1. General-purpose register: When the PLC begins to run, or is disconnected, the value in the register will be cleared to zero. If users want to retain the data when the PLC begins to RUN, they can refer to ISPSOft User Manual for more information. Please notice that the value will still be cleared to zero when the PLC is disconnected.
2. Latched register: If the PLC is disconnected, the data in the latched register will not be cleared. In other words, the value before the disconnection is still retained. If users want to clear the data in the latched area, they can use RST or ZRST.

5.2.13 Special Data Registers

Every special data register has its definition and specific function. Please refer to section 2.2.14 in AH500 Programming Manual for more information.

5.2.14 Link Registers

The link register is mainly used in the PLC Link or the Ether Link. When the data exchange occurs between the AH500 series programmable logic controllers, the link register can be used as the buffer. Please refer to chapter 11 for more information.

The link registers L0~L65535 add up to 65536 words. (The device range varies with the model selected.) Besides, the link register can be used as the general auxiliary register.

5.2.15 Index Registers

The index register is the 16-bit data register. It is like the general register in that the data can be read from it and written into it. However, it is mainly used as the index register. The range of index registers is E0~E13. Please refer to section 4.2 in AH500 Programming Manual for more information about the usage of index registers.

6

Chapter 6 Writing a Program

Table of Contents

6.1	Quick Start.....	6-2
6.1.1	Example.....	6-2
6.1.2	Hardware	6-2
6.1.3	Program.....	6-2
6.2	Procedure for Creating a Project in ISPSOft.....	6-3
6.3	Creating a Project.....	6-3
6.4	Hardware Configuration.....	6-4
6.4.1	Configuring a Module.....	6-5
6.4.2	Setting the Parameters in a CPU Module and a Module	6-6
6.5	Creating a Program	6-8
6.5.1	Adding a Ladder Diagram	6-9
6.5.2	Basic Editing—Creating a Contact and a Coil	6-11
6.5.3	Basic Editing—Inserting a Network and Typing an Instruction.....	6-14
6.5.4	Basic Editing—Selection of a Network and Operation.....	6-16
6.5.5	Basic Editing—Connecting a Contact in Parallel	6-17
6.5.6	Basic Editing—Editing a Comment.....	6-18
6.5.7	Basic Editing—Inserting an Applied Instruction	6-19
6.5.8	Basic Editing—Creating a Comparison Contact and Typing a Constant....	6-21
6.5.9	Writing a Program	6-22
6.5.10	Checking and Compiling a Program.....	6-23
6.6	Testing and Debugging a Program	6-23
6.6.1	Creating a Connection	6-23
6.6.2	Downloading a Program and Parameters.....	6-26
6.6.3	Connection Test.....	6-27
6.7	Setting a Real-time Clock	6-34

6.1 Quick Start

The chapter provides a simple example, and leads users to create a traditional ladder diagram in ISPSOft in a short time. However, in order to help users who are not familiar with IEC 61131-3 understand the functions provided by ISPSOft, and create a traditional ladder diagram, programming concepts related to IEC 61131-3 are not introduced in this chapter. For example, POU's, function blocks, variables, and etc. are not introduced.

6.1.1 Example

When the equipment operates, the parts on the conveyer are conveyed from left to right. If a sensor senses that a part is under an injector, the PLC will send a trigger signal to the injector, and the injector will injects the glue. How long the part will be injected is set externally, and is not controlled by the program in the PLC. However, the program in the PLC must be able to turn the trigger signal OFF so that the trigger signal can be sent next time. There are two injectors above the conveyer, and the two injectors inject glue in the same way. Besides, there is a sensor at the left side of the conveyer. When a part passes the sensor, the sensor value increases by one increment. If the sensor value is 100, the internal completion flag will be set to ON. The state of the flag can be used by other procedures later. However, the use of the state of the flag is not introduced in this example.

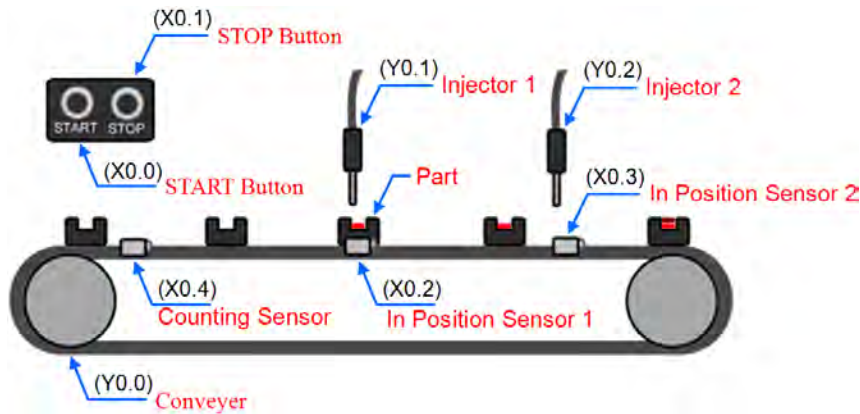

6

6.1.2 Hardware

In this example, the AH500 series CPU module used is **AHCPU530-EN**, the digital I/O module used is **AH16AP11R-5A**, and the main backplane used is **AHP04M1-5A**. The table below is an I/O allocation table.

Type	ID	Description
Digital input	X0.0	START button
Digital input	X0.1	STOP button
Digital input	X0.2	In position sensor 1
Digital input	X0.3	In position sensor 2
Digital input	X0.4	Counting sensor
Digital output	Y0.0	Conveyer
Digital output	Y0.1	Trigger signal for injector 1
Digital output	Y0.2	Trigger signal for injector 2

6.1.3 Program

- (1) When the START button (X0.0) is turned from OFF to ON, the internal operation flag is set to ON, and the conveyer (Y0.0) starts to run. When the STOP button (X0.1) is turned from OFF to ON, an error occurs (the error flag is ON), the operation flag is reset to OFF, and the conveyer stops running.
- (2) When in position sensor 1 (X0.2) is ON, the trigger signal for injector 1 (Y0.1) is set to ON. When in position sensor 1 is OFF, the trigger signal for injector 1 is reset to OFF.
- (3) When in position sensor 2 (X0.3) is ON, the trigger signal for injector 2 (Y0.2) is set to ON. When in position sensor 2 is OFF, the trigger signal for injector 2 is reset to OFF.
- (4) When the counting sensor (X0.4) is turned from OFF to ON, the sensor value increases by one increment. If the sensor value is larger than or equal to 100, the internal completion flag will be set to ON.

6.2 Procedure for Creating a Project in ISPSoft

The procedure for creating a project in ISPSoft is as follow. Users can adjust the procedure according to the practical application and their habits.

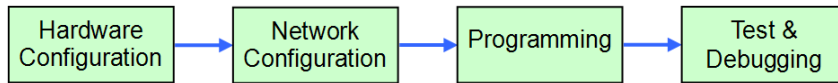

- **Hardware configuration**

Users can set the parameters such as a range of latched devices and a port number in a PLC. Besides, the users have to configure modules used with an AH500 series CPU module, and set the parameters in these modules.

- **Network configuration**

If a system used adopts network architecture, or devices need to exchange data, users can configure a network, a PLC Link, or an Ether Link easily through the network configuration tool **NWCONFIG** in ISPSoft.

- **Programming**

After users write a program in ISPSoft, they can compile the program. If the compiling of a program is unsuccessful, the messages in the **Compile Message** page can lead users to the places where errors occur to check the program code.

- **Test and debugging**

Users can download a program which is compiled, a hardware configuration, and a network configuration to a PLC. Besides, the users can test and debug the program online by means of the functions provided by ISPSoft.

Owing to the fact that the example introduced in this chapter does not discuss a network configuration, only the following procedure is carried out. The procedure will be introduced in the following section.

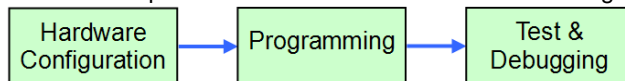

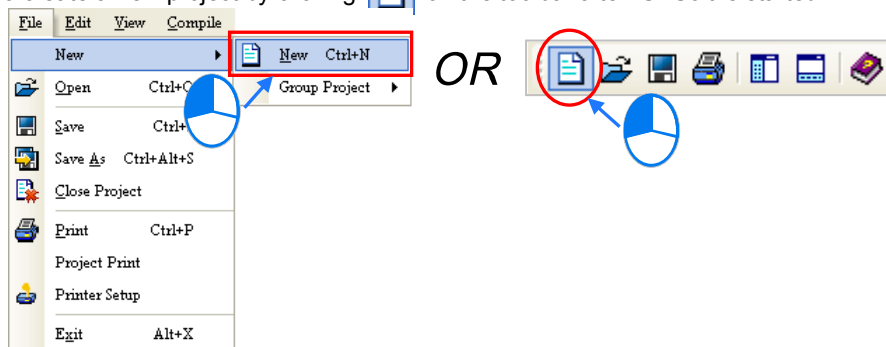

6.3 Creating a Project

After ISPSoft is started, users can click the **File** menu, point to **New**, and click **New** to create a new project. They can also create a new project by clicking  on the toolbar after ISPSoft is started.

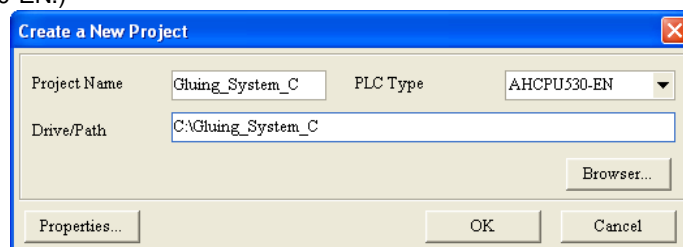

In the **Create a New Project** window, type a project name in the **Project Name** box and a path in the **Drive/Path** box, select a PLC in the **PLC Type** drop-down list box, and click **OK**. (The PLC used in this example is AHCPU530-EN.)



After the project is created successfully, a project management area will appear at the left side of the main screen. The relation between the items listed in the project management area is represented by a hierarchical tree structure. If the project management area does not appear, the users can click **Workspace** on the **View** menu, or click  on the toolbar.



6.4 Hardware Configuration

After users double-click **HWCONFIG** in the project management area, the **HWCONFIG** window will appear.

6

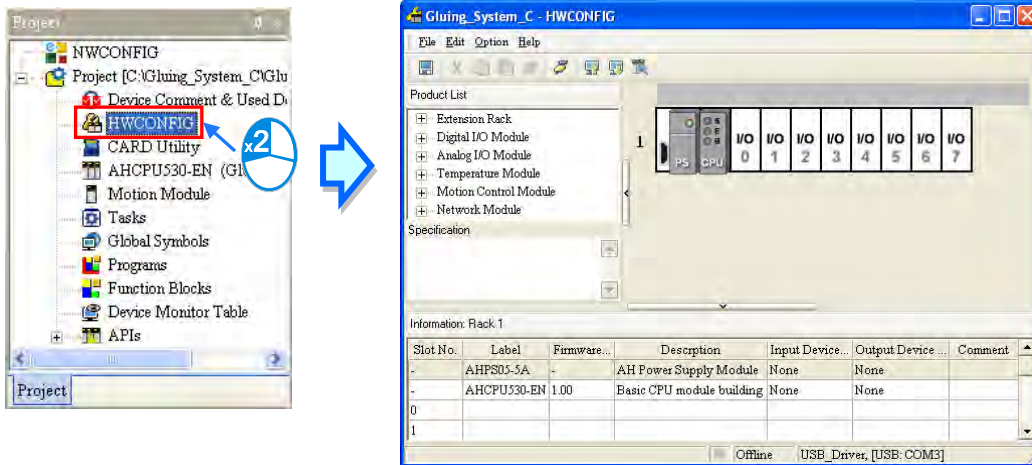

6.4.1 Configuring a Module

In the **HWCONFIG** window, there is an eight-slot backplane on which a CPU module and a power supply module are installed. However, the backplane used in this example is the four-slot backplane **AHBP04M1-5A** on which the digital I/O module **AH16AP11R-5A** is installed.

If users want to replace the backplane, they can right-click the left side of the rack in the system configuration area, click **Replace** on the context menu, and double-click **AHBP04M1-5A** in the **Rack Selection** window.

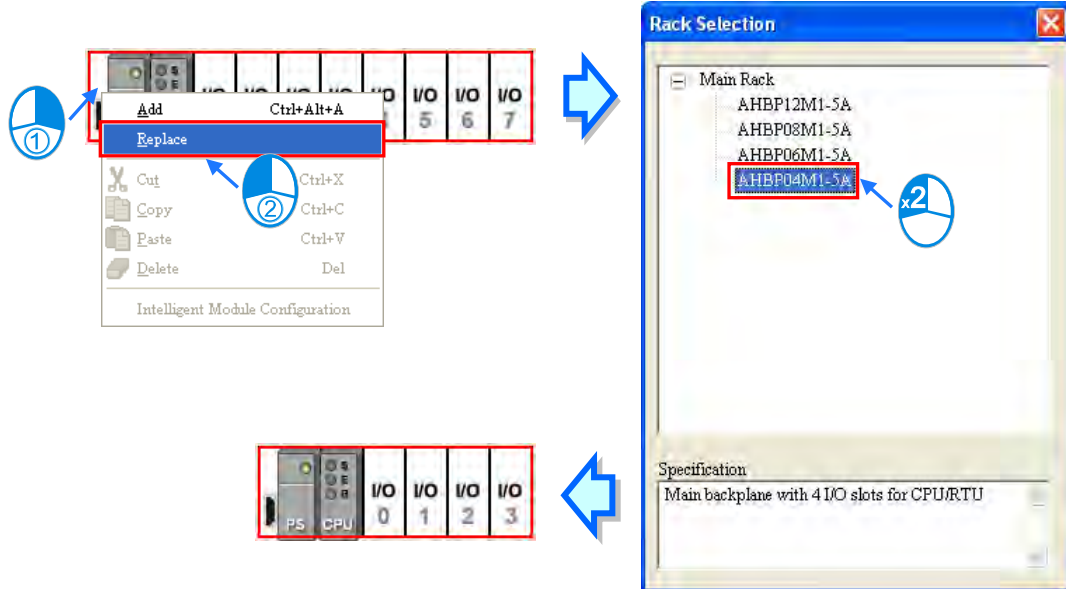

Unfold the **Digital I/O Module** section on the product list, find **AH16AP11R-5A**, and drag the module to a vacant slot on the backplane in the system configuration area. After the module is added successfully, the related information and the devices assigned to the module will be listed in the table at the bottom of the window.

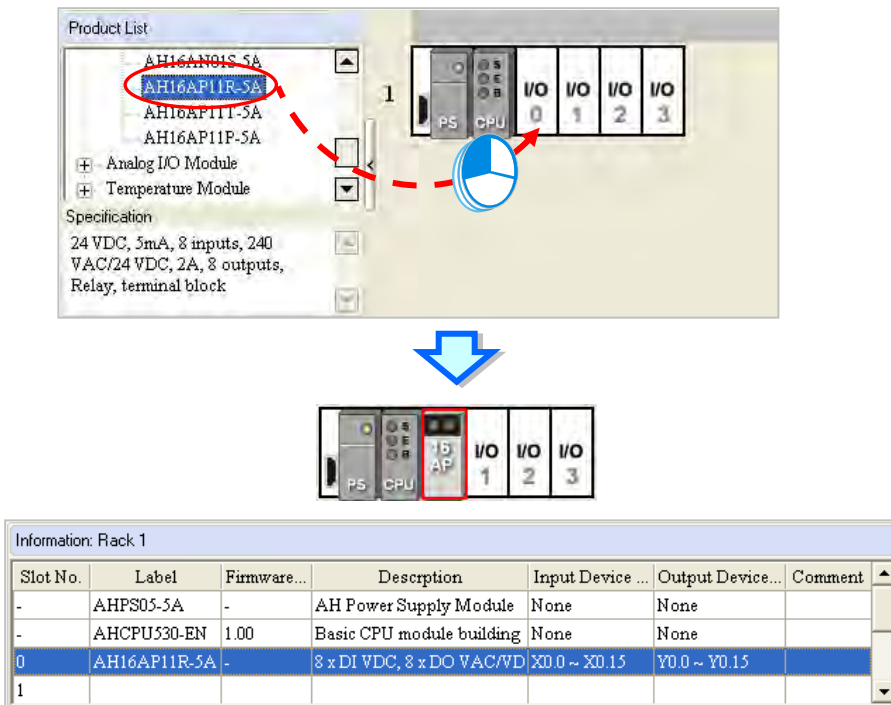

6

The system automatically assigns devices to a module which is added. If the devices assigned to a module do not conform to what is expected, users can click the **Input/Output Device Range** cell for the module, click **...** in the cell, and type a device address in the **Manual Assignment** window.

Information: Rack 1

Slot No.	Label	Firmware...	Description	Input Device ...	Output Device...	Comment
-	AHPS05-5A	-	AH Power Supply Module	None	None	
-	AHCPU530-EN	1.00	Basic CPU module building	None	None	
0	AH16AP11R-5A	-	8 x DI VDC, 8 x DO VAC/VD	X0.0 ~ X0.15	Y0.0 ~ Y0.15	
1						

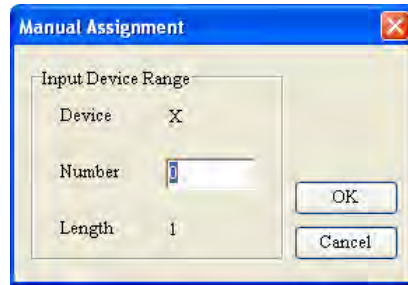

6.4.2 Setting the Parameters in a CPU Module and a Module

After **AH16AP11R-5A** is configured, users can set the parameters in the CPU module and the parameters in the extension module. After the users double-click the CPU module or the extension module, a corresponding window will appear.

After the CPU module is double-clicked, the **PLC Parameter Setting** window will appear. The users can click the primary tabs at the top of the window, and the secondary tables at the bottom of the window to set the parameters. In this example, the users only need to define the name of the CPU module.

After the users click the **CPU** tab at the top of the window, and the **Name** tab at the bottom of the window, they can type a name in the **Name** box. The users will find the default name in the **Name** box is the same as the project name. Delete the default name, type "Main_Controller" in the **Name** box, and click **OK**.

6

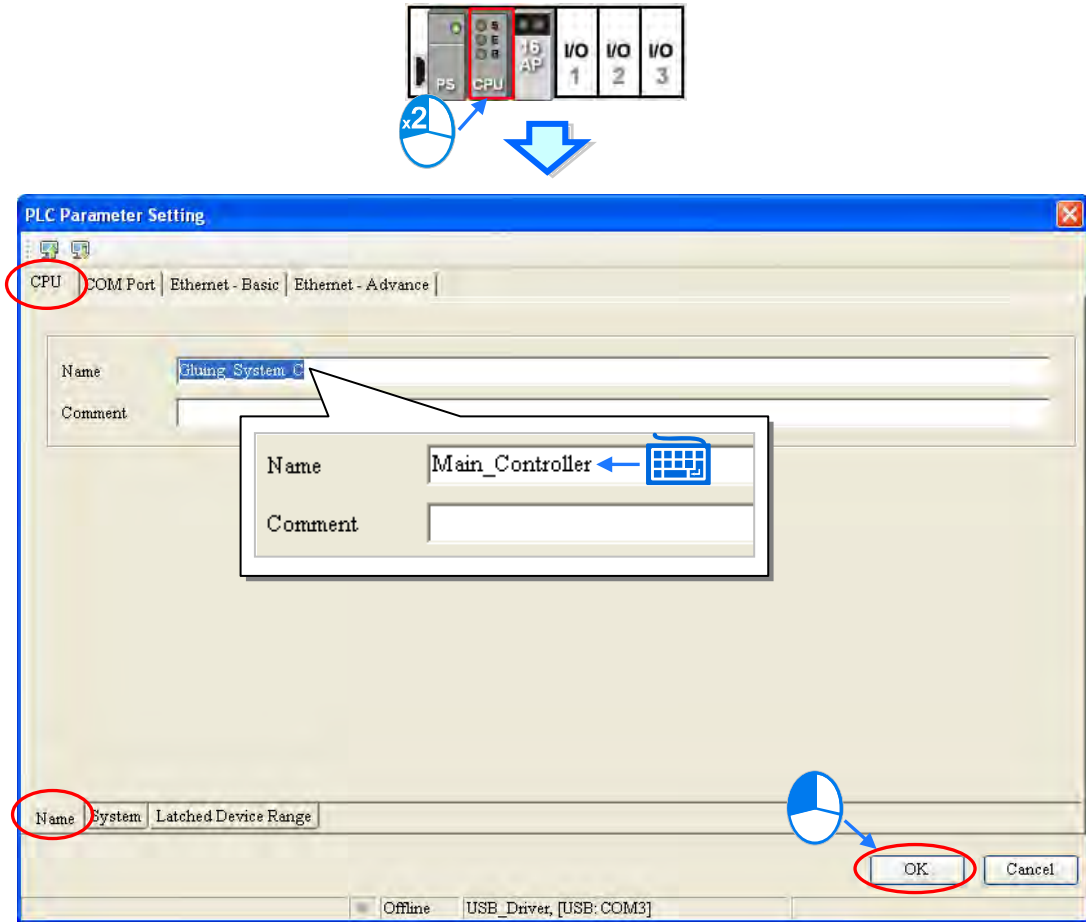

After the users double-click AH16AP11R-5A, the **Parameter Setting** window will appear.

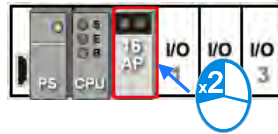

After the **Parameter Setting** window is opened, the users can view the information related to the module. The users can select the parameter type at the left side of the window, and then set the parameter in the table at the right side of the window.

In this example, the default values are retained. Therefore, the step of setting the parameter in AH16AP11R-5A is skipped.

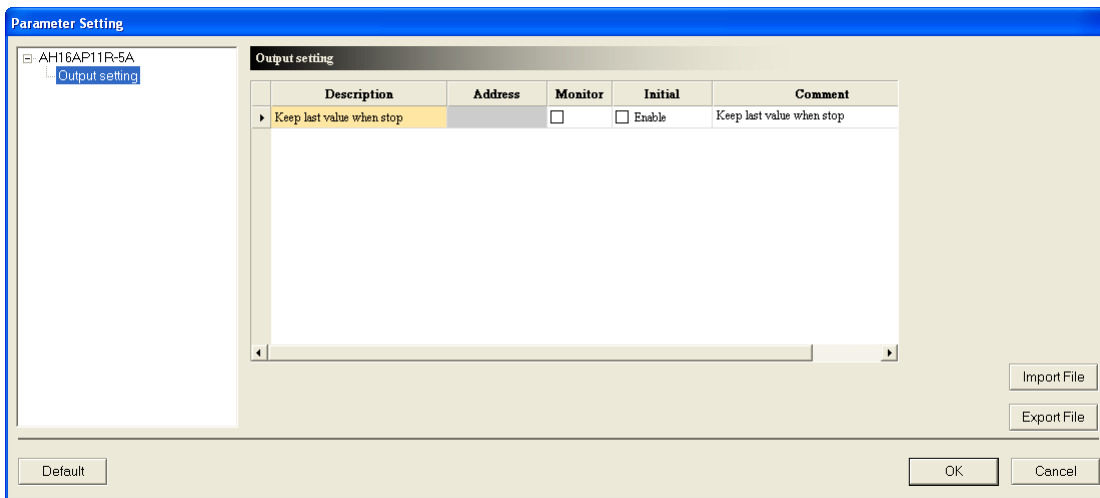
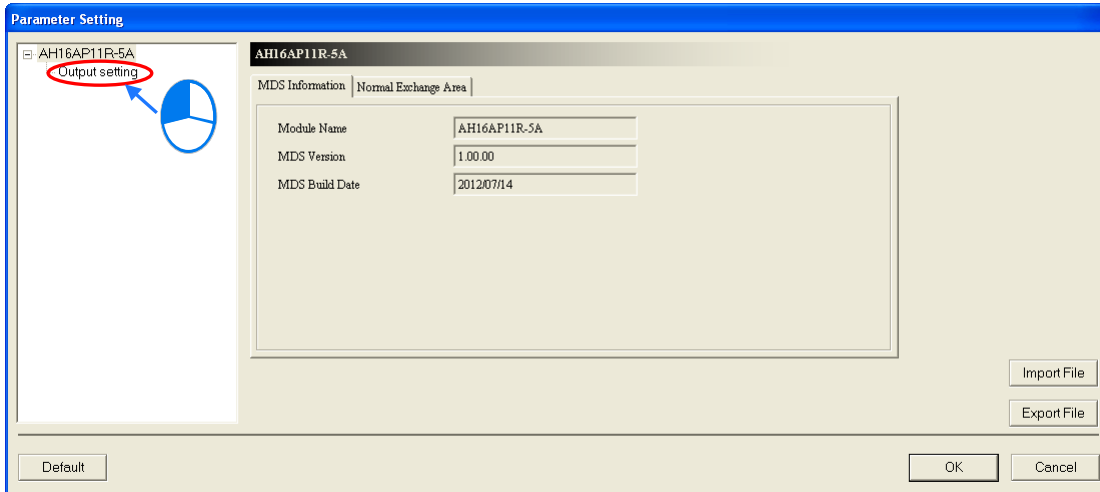

6

The hardware configuration is not complete until the parameters in the CPU module and AH16AP11R-5A are set. However, the configuration and the setting must be downloaded to the CPU module so that they can take effect. The configuration and the setting are saved here, and will be downloaded with the program in the project later.

If the users want to save the configuration and the setting, they can click **Save** on the **File** menu, or  on the toolbar. After the configuration and the setting are saved, the users can close the **HWCONFIG** window.



*. Please refer to chapter 8 for more information about HWCONFIG.

6.5 Creating a Program

The following sections will lead users to create a traditional ladder diagram in ISPSOft. The contents of the following sections include creating a POU, editing a traditional diagram, and compiling a program. The users are expected to equip themselves with the basic abilities to create a traditional ladder diagram in a short time.

6.5.1 Adding a Ladder Diagram

- (1) Right-click **Programs** in the project management area, point to **POU** on the context menu, and click **New...**

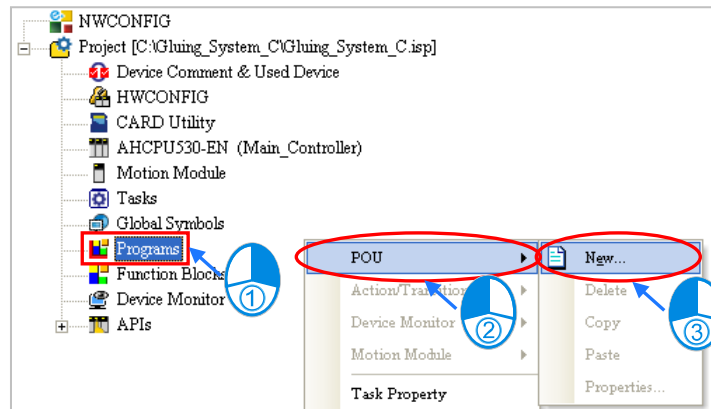

- (2) Type a program name in the **POU Name** box, select the **Ladder Diagram (LD)** option button in the **Language** section, and retain the other default values. Click **OK** after the setting is complete. An item will be under **Programs** in the project management area. The item is a program organization unit (POU).

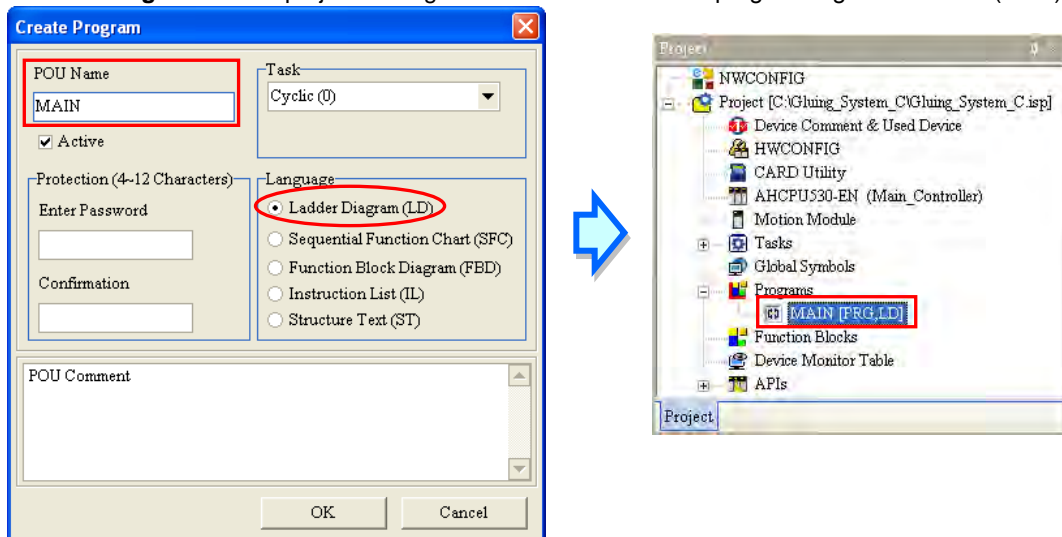

- (3) After the POU is added, a program editing window will appear in the main working area.

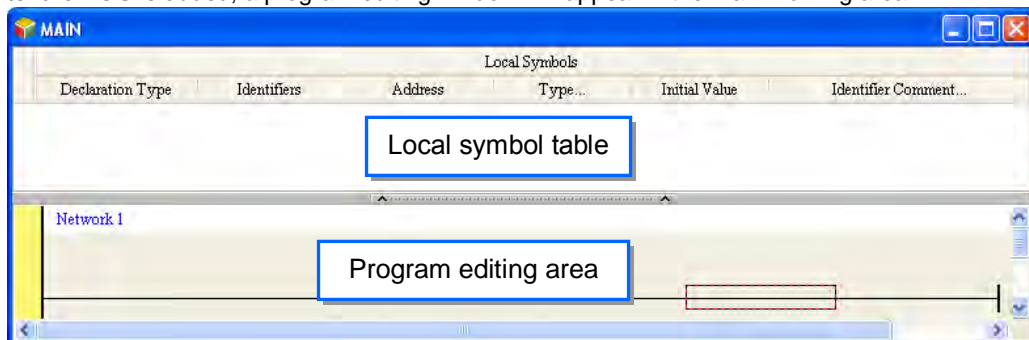

After the program editing window is opened, the corresponding toolbar will appear in the window. The functions are described below.



Icon	Keyboard shortcut	Function
	Shift+Ctrl+C	Displaying/Hiding the comments on the networks
	None	Displaying/Hiding the commands on the devices
	Shift+Ctrl+A	Activating/Inactivating the network selected
	Shift+Ctrl+B	Adding a bookmark to the network selected or deleting a bookmark from the network selected
	Shift+Ctrl+P	Going to the previous bookmarked position
	Shift+Ctrl+N	Going to the next bookmarked position
	Ctrl+I	Putting a network above the network selected
	Shift+Ctrl+I	Putting a network under the network selected
	ESC	Selection
	Typing an instruction	Inserting a contact
	Typing an instruction	Inserting a coil
	Typing an instruction	Inserting a comparison contact
	Typing an instruction	Selecting a type of comparison contact
	Typing an instruction	Inserting a block logic instruction (NP/PN/INV/FB_NP/FB_PN)
	Typing an instruction	Selecting a type of block logic instruction (NP/PN/INV/FB_NP/FB_PN)
	Shift+Ctrl+U	Inserting an instruction or a function block

*. Please refer to section 6.5.3 for more information about typing an instruction.

6

6.5.2 Basic Editing—Creating a Contact and a Coil

- (1) Click  on the toolbar, and then move the mouse cursor to the red frame in network 1. The mouse cursor appears as a contact when the mouse cursor is moved to the left side of the red frame, the right side of the red frame, or the bottom of the red frame. Users can decide where to insert a contact. If a ladder diagram is edited, the mouse cursor must be near a position which is edited. Besides, an object inserted is arranged by the system automatically. Users can not move the object at will. In this example, users do not need to decide where to insert the contact. Therefore, the mouse cursor can be near the red frame, and the users can click the left mouse button.

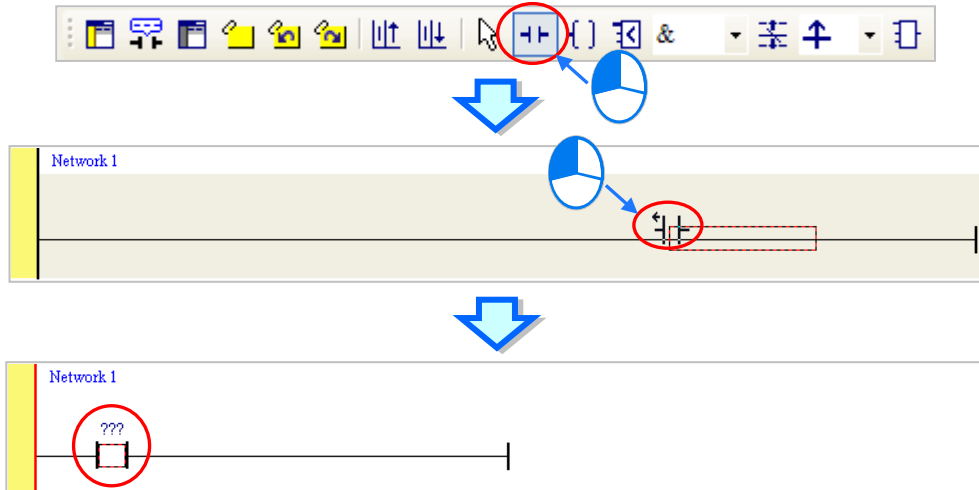

- (2) Click  on the toolbar, or press Esc on the keyboard. After the contact is double-clicked, a drop-down list will appear. The items on the drop-down list are **Normally Open**, **Normally Close**, **Rising-edge Trigger**, and **Falling-edge Trigger**. In this example, **Rising-edge Trigger** is selected.

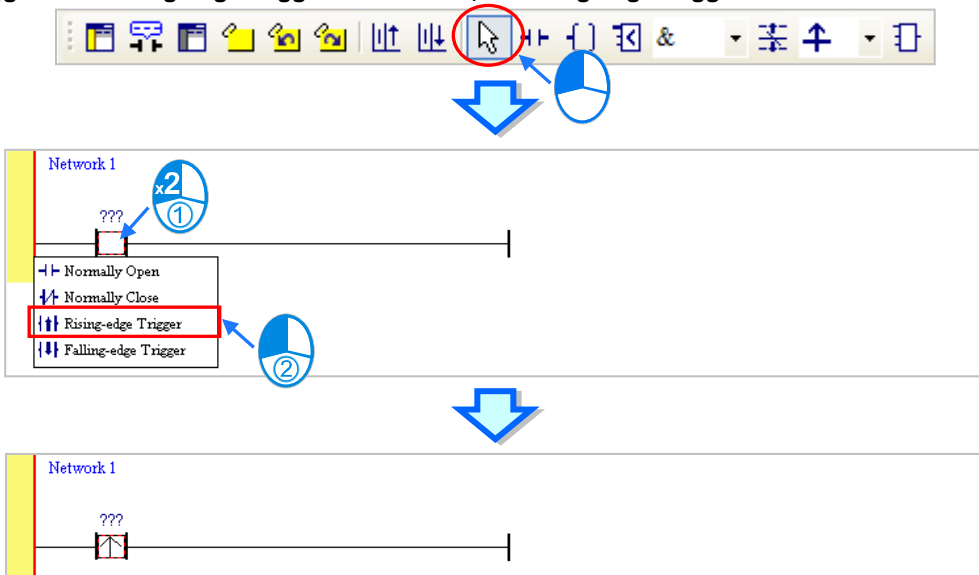

- (3) Click the line at the right side of the contact, click  on the toolbar, and move the mouse cursor to the red frame. Likewise, the mouse cursor appears as a coil when the mouse cursor is above or under the red frame. Users can decide where to insert the coil. In this example, the users do not need to decide where to insert the coil. Therefore, the mouse cursor can be near the red frame, and the users can click the left mouse button.

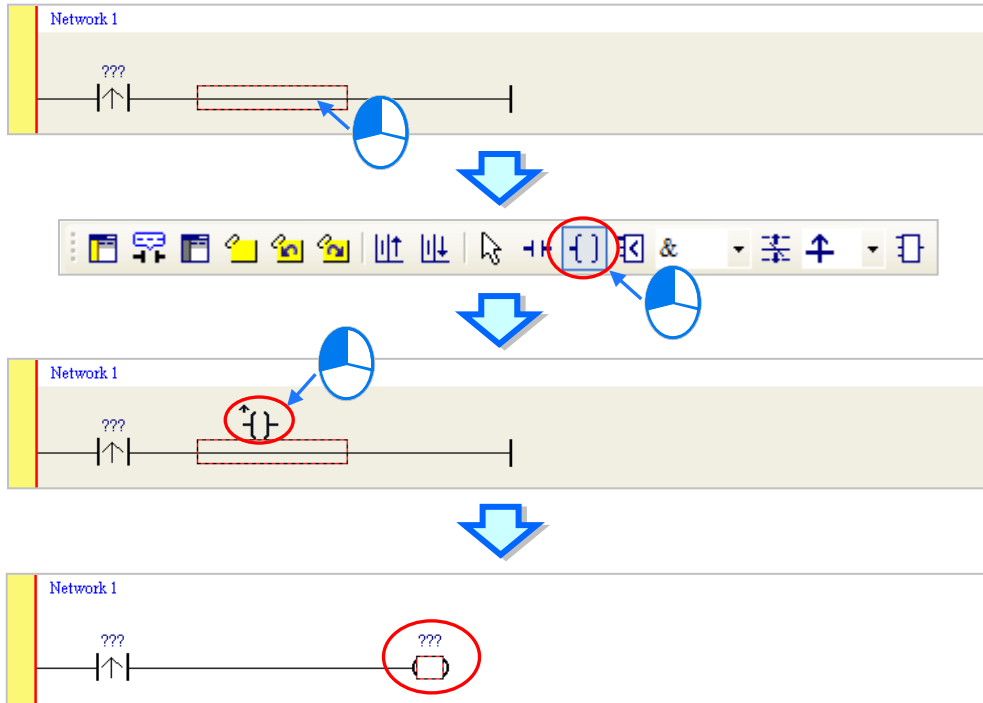

- (4) Click  on the toolbar, or press Esc on the keyboard. After the coil is double-clicked, a drop-down list will appear. The items on the drop-down list are **Out**, **Set**, and **Reset**. In this example, **Set** is selected.

6

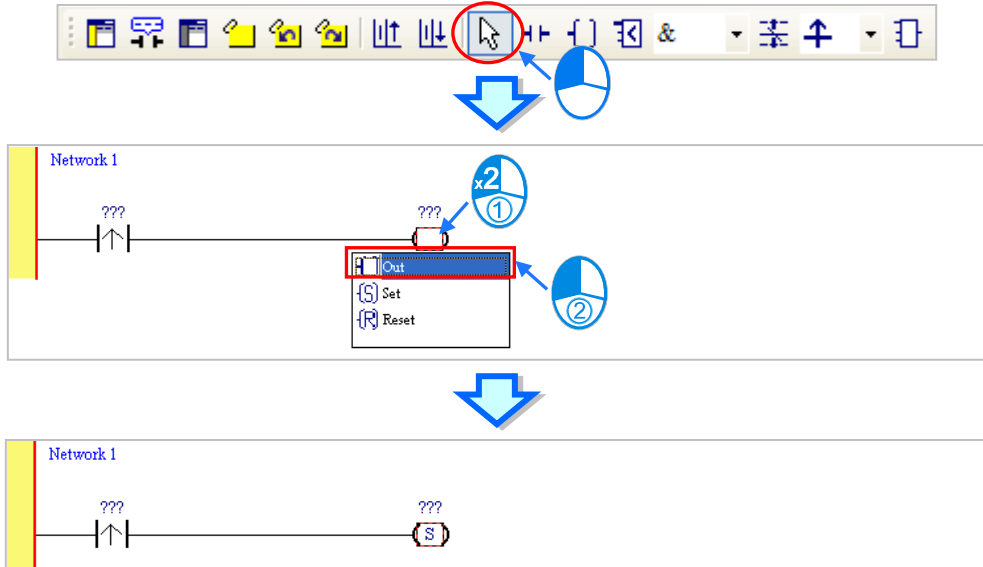

- (5) Click ??? above the contact, type a device address in the box, and press Enter on the keyboard to jump to the next box in the network. After a device address is typed in the box, the users can press Esc on the keyboard to complete the editing. In this example, X0.0 is typed in the box for the contact, and M0 is typed in the box for the coil.

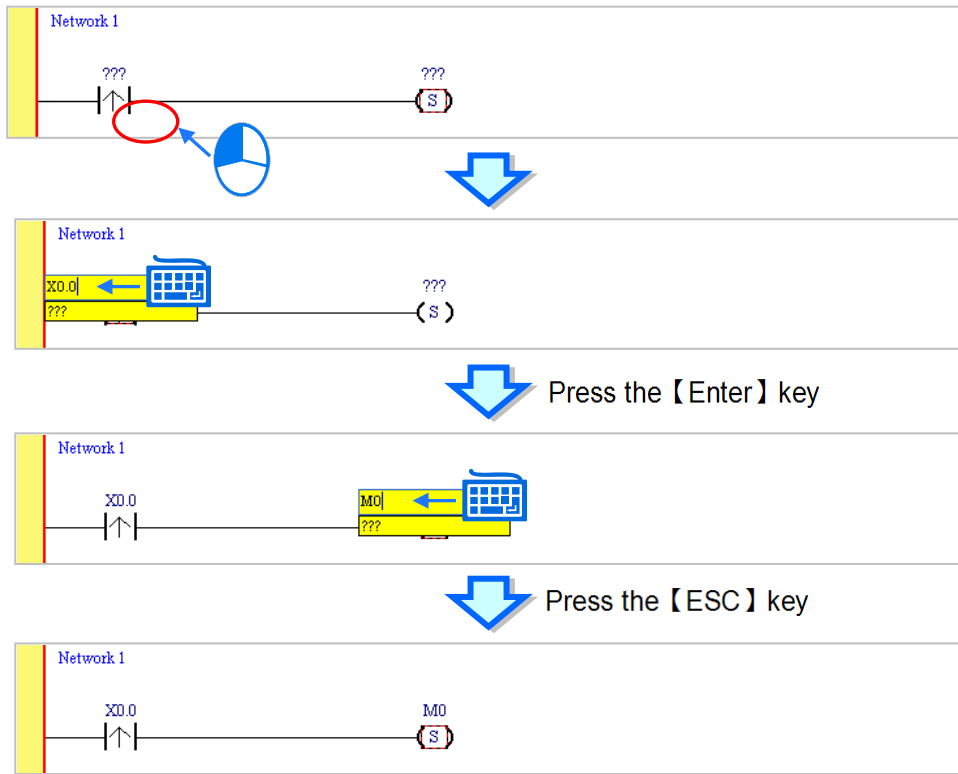



Additional remark

After users click a network and press Enter on the keyboard, they can edit a box. The users can edit the next box in the network after they press Enter on the keyboard. Besides, the next network is selected after the users press Tab on the keyboard. The users can edit a box with the keyboard. After the editing is complete, the users can press Enter on the keyboard to jump to the next box. If the users want to end the editing, they can press Esc on the keyboard.

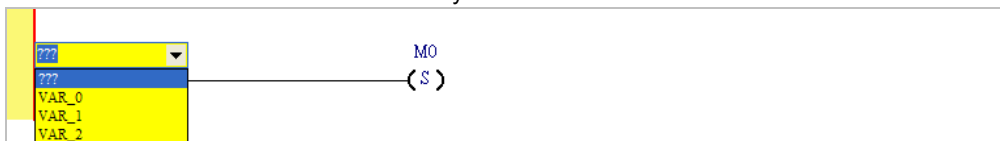

If the users have declared symbols, they can click  in a box, or press Page Down on the keyboard when they edit the box. The symbols on the drop-down list are the symbols which can be assigned to the object. The users can select a symbol by the mouse or the up/down key on the keyboard. Please refer to chapter 6 in ISPSOft User Manual for more information about symbols.

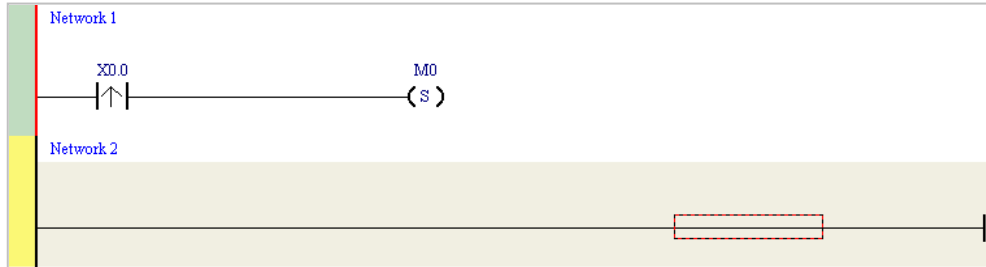
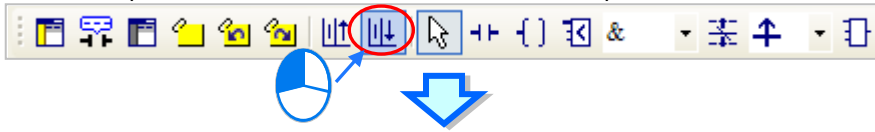

6.5.3 Basic Editing—Inserting a Network and Typing an Instruction

After  on the toolbar is clicked, a network will be under the network selected. After  on the toolbar is clicked, a network will be put above the network selected. In this example, a network is under network 1.



A contact and a coil can be created not only by clicking  and  on the toolbar, but also by typing instructions.

(1) Click the line in network 2.

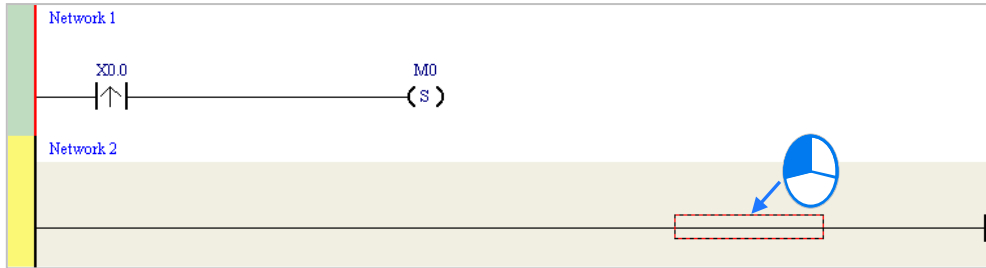

(2) Type the IL instruction "LD M0". (The instruction is case-insensitive.) As soon as the IL instruction is typed, a box which can be edited appears. After the typing of the IL instruction is complete, users can press Enter on the keyboard or click **OK** at the right side of the box.

6

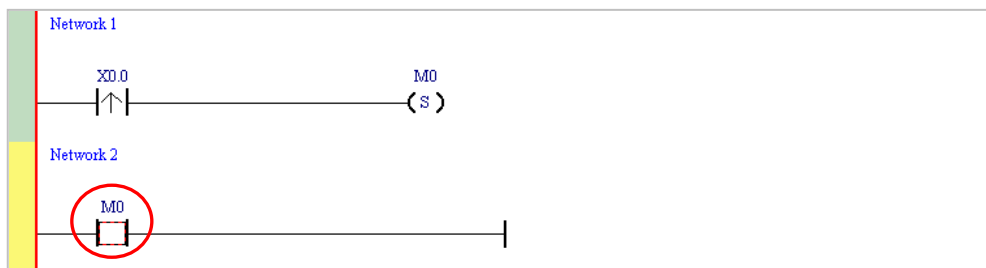
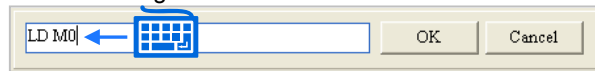

(3) Type the IL instruction “OUT Y0.0”, and write the program shown below.

OUT Y0.0 OK Cancel

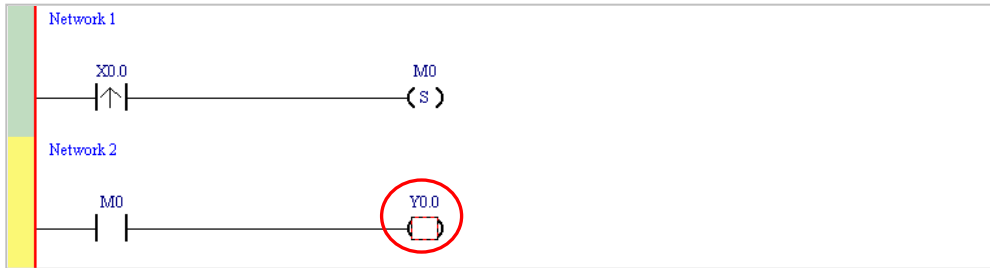

Additional remark

A contact and a coil can be created by typing simple instructions. Please refer to the description below. (The instructions typed are case-insensitive.)

- Inserting a normally-open contact (contact A): “A Device address”

A M100 OK Cancel

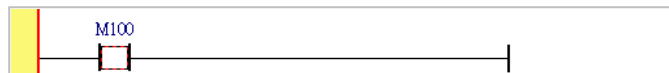

- Inserting a normally-closed contact (contact B): “B Device address”

B M110 OK Cancel



- Inserting an output coil (OUT): “O Device address”

O M120 OK Cancel



6.5.4 Basic Editing—Selection of a Network and Operation

Before an object in a network is selected, users have to press Esc on the keyboard, or click  on the toolbar. After the cursor appears as a small arrow, the users can click the object in the network. The basic selection is shown below.

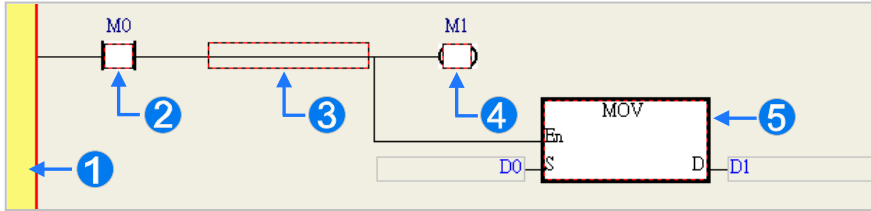

- ❶ Selecting the network
- ❷ Selecting the input contact
- ❸ Selecting the network
- ❹ Selecting the output coil
- ❺ Selecting the block

If users want to select a group of devices, they can click a device, and drag it to draw a frame round the group of devices. The users can also select the group of devices by clicking the first device, pressing Ctrl+B on the keyboard, clicking the last device, and pressing Ctrl+B on the keyboard. Users must draw a frame round devices which are in the same network, and the devices must be adjacent to one another. Besides, input devices and output devices can not be in the same frame.

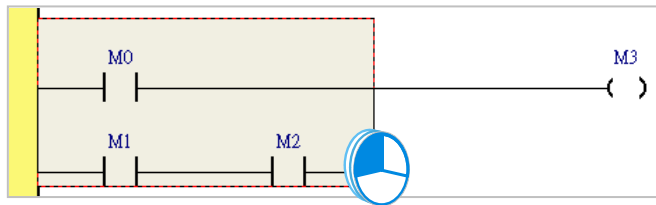

6

If users want to select several networks, they can press Ctrl on the keyboard, and click the networks. The users can also select a range of networks by pressing Shift on the keyboard, clicking the first network within the range, and the last network within the range.

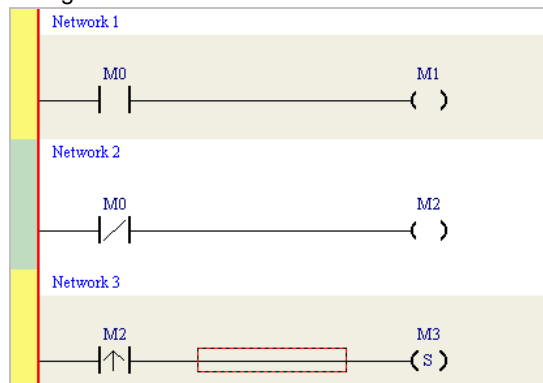

If users right-click an object after the object is clicked, they can click an item on the context menu.

Item	Function
Undo	Undoing the last action (The number of previous actions that can be undone is 20.)
Redo	Redoing an action which has been undone
Cut	Cutting a device, a block, or a network
Copy	Copying a device, a block, or a network
Paste	Paste an object which has been copied or cut on the present position
Paste right	Pasting an object at the right side of the position selected (The object will be connected to the position selected in series.)

Item	Function
Paste under	Pasting an object under the position selected (The object will be connected to the position selected in parallel.)
Delete	Deleting a device, a block, or a network
Activate/Inactivate Network	Activating or Inactivating the network selected (The network which is inactivated is ignored when the program is compiled.)

Users can proceed with the operation in the example.

- (1) Select network 1, right-click network 1, and click **Copy** on the context menu.

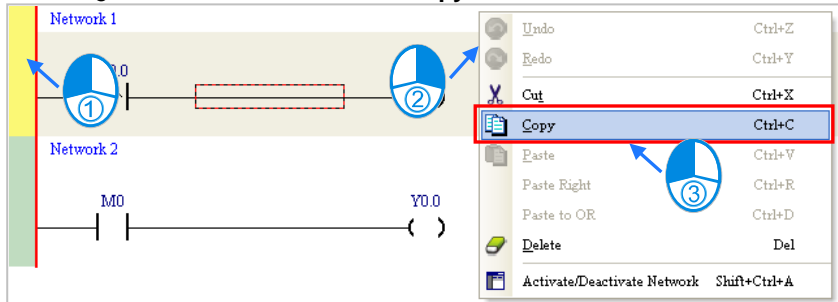

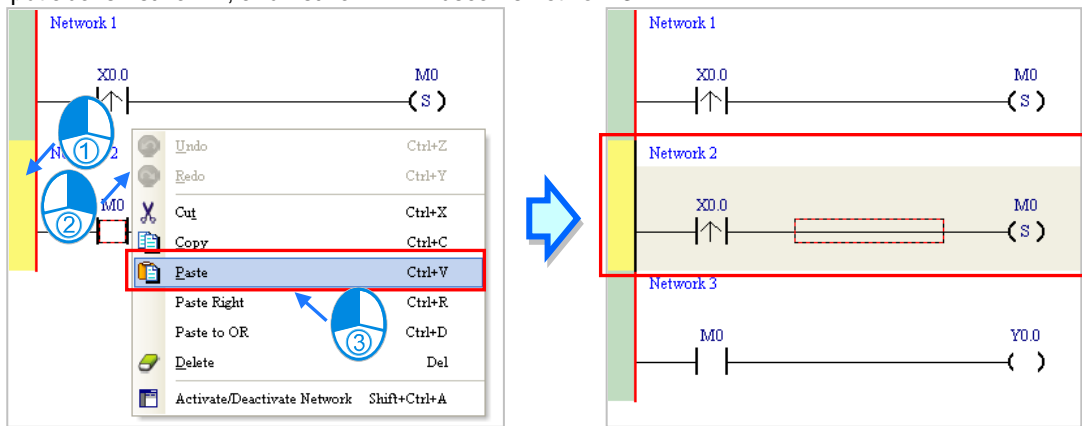

- (2) Select network 2, right-click network 2, and click **Paste** on the context menu. A copy of network 1 will be put above network 2, and network 2 will become network 3.



6

6.5.5 Basic Editing—Connecting a Contact in Parallel

- (1) Click  on the toolbar, and then move the mouse cursor to the input contact in network 2. The mouse cursor will appear as a contact. Move the mouse cursor to the button of the input contact in network 2. After the mouse cursor appears as , users can click the left mouse button. A contact will be connected to the input contact in network 2 in parallel.

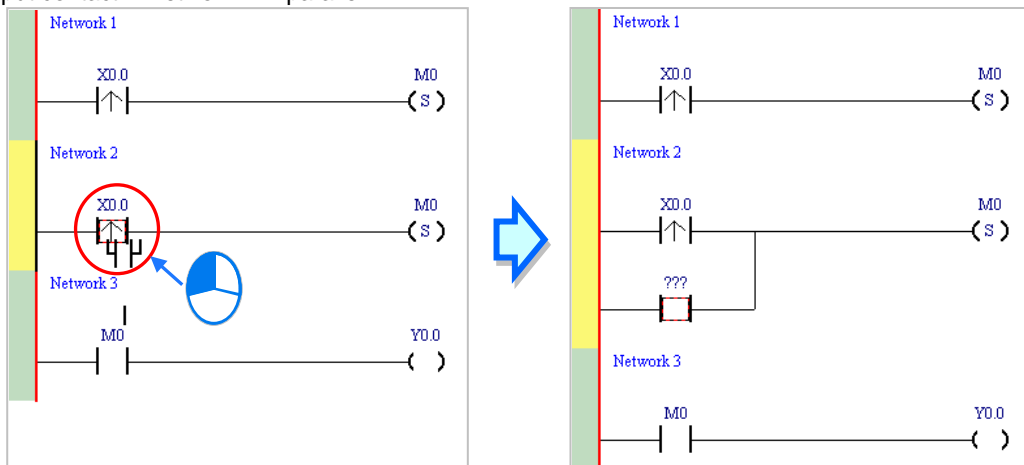

(2) Write the program in network 2 shown below in the way described above.

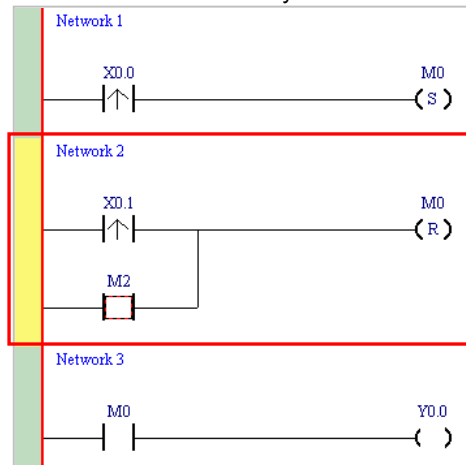

Additional remark

After users select a group of contacts, they can connect a contact to the group of contacts in the way described above.

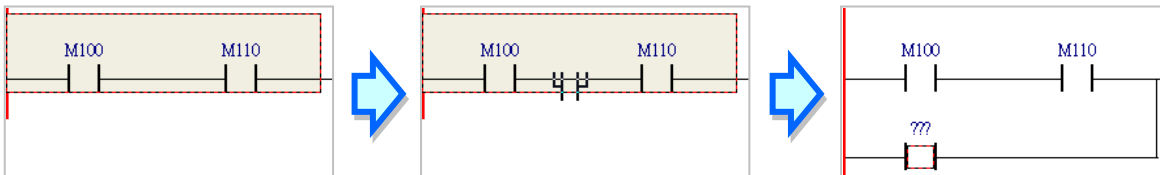

6.5.6 Basic Editing—Editing a Comment

(1) Make sure that on the toolbar is pressed. Click the position above a device name, type a comment in the box, and press Enter on the keyboard.

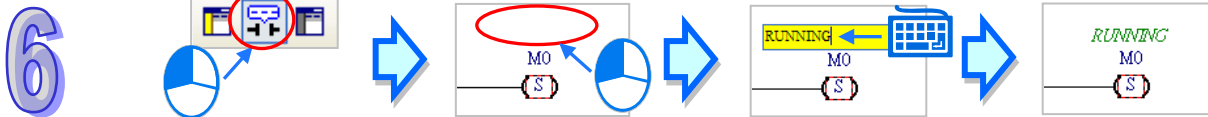

(2) Make sure that on the toolbar is pressed. Click the position under a network number, and then type a comment in the box. If users want to start a new line of text at a specific point, they can press Shift+Enter on the keyboard. Press Enter on the keyboard after the editing is complete.

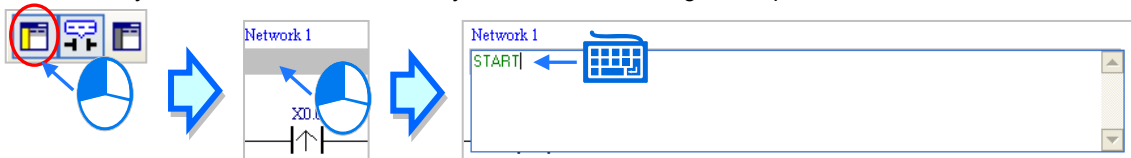

(3) Write the program shown below in the way described above.

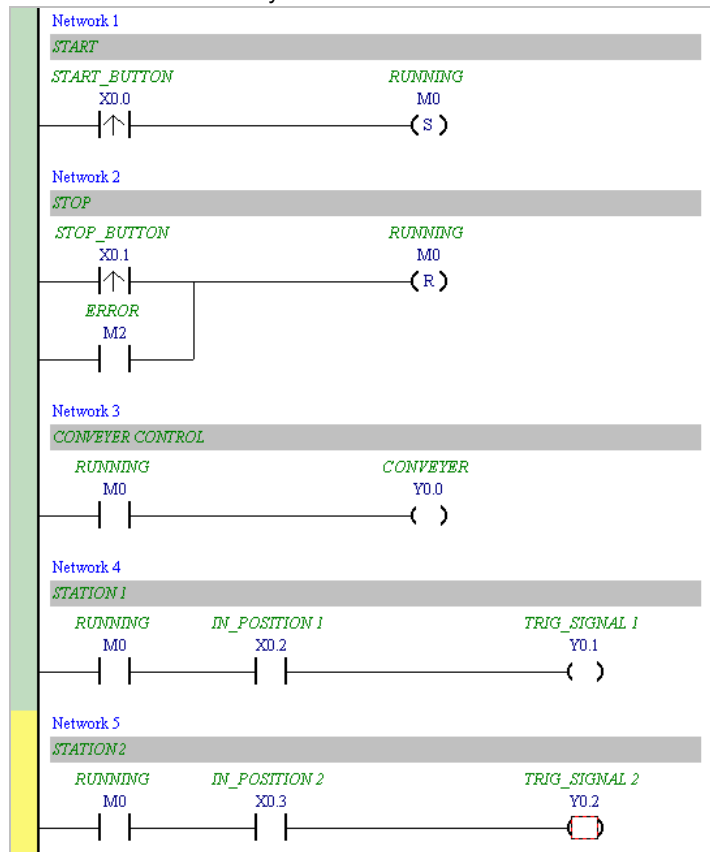

6.5.7 Basic Editing—Inserting an Applied Instruction

Put network 6 under network 5, and then write the program shown below. Users can insert an applied instruction in one of the three ways described below.

6

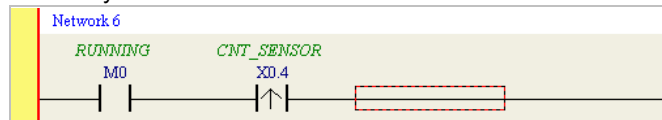

- Method 1
Click the position where an instruction will be inserted, type the instruction (INC in this example), and press Enter on the keyboard.

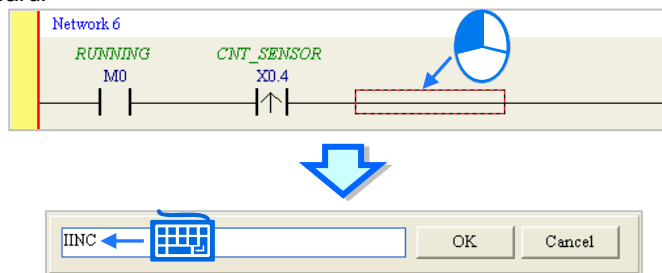

- Method 2

Unfold the **APIs** section in the project management area, find the instruction type, and unfold the instruction type section.

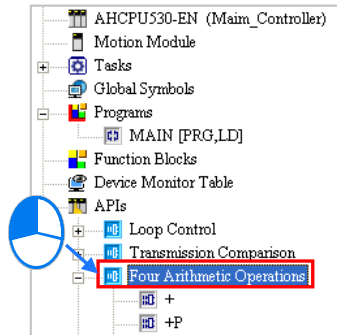

Select the instruction (INC in this example) which will be inserted, and then drag it to the position where it will be inserted.

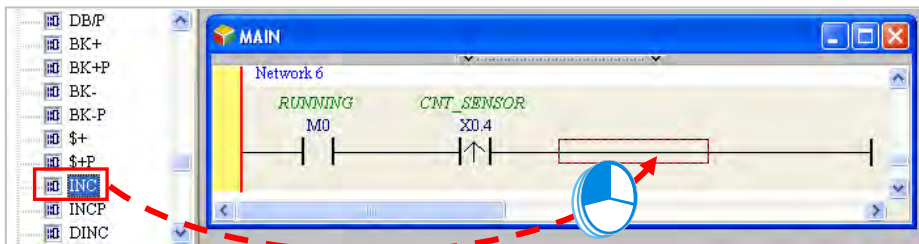

- Method 3

Click the position where an instruction will be inserted, click  on the toolbar, select the instruction (INC in this example) which will be inserted in the **API/FB** window, and click **Insert**.

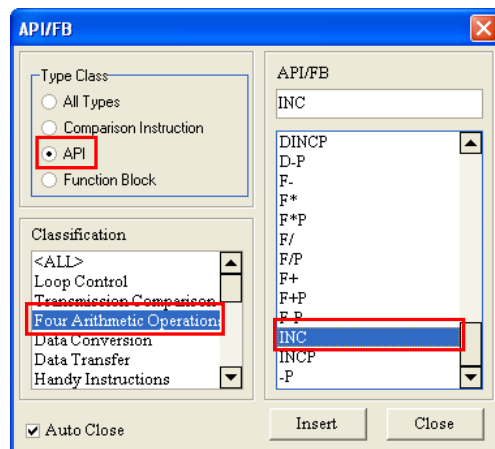
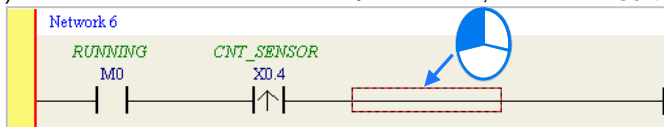

6

After the instruction is inserted successfully, the users can assign a device address to the operand, and write the program shown below.

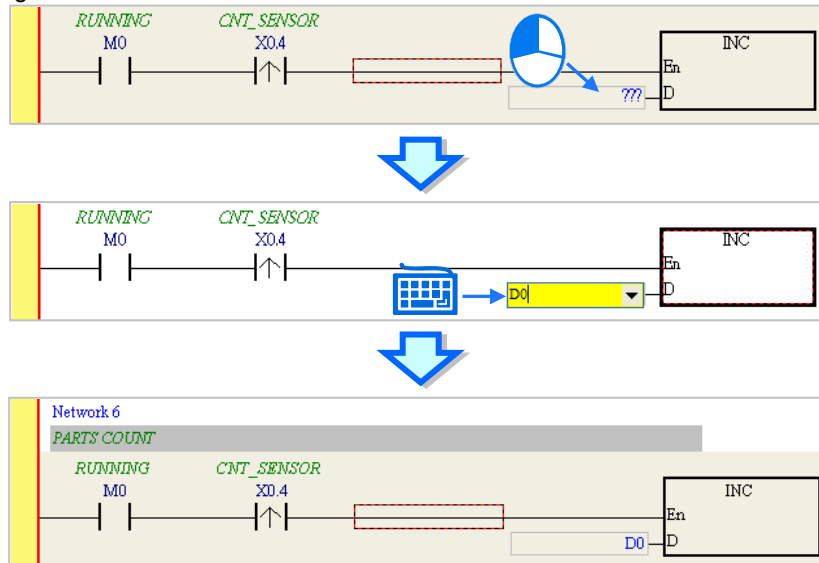

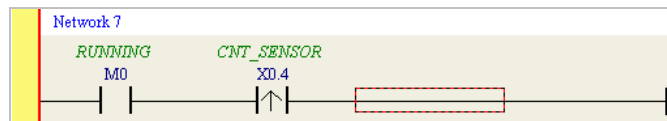

6.5.8 Basic Editing—Creating a Comparison Contact and Typing a Constant

A comparison contact can be inserted not only in one of the three ways described in section 6.5.7, but also by means of the following steps. Users need to put network 7 under network 6, and write the program shown below.

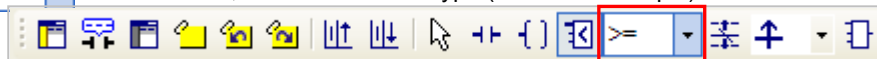

- (1) Click  on the toolbar, and then select a type (>= in this example).



- (2) Click  on the toolbar, and then move the mouse cursor to the position where the comparison contact will be inserted. The mouse cursor appears as a comparison contact when the mouse is moved to the left side of the red frame, the right side of the red frame, or the bottom of the red frame. The users can decide where to insert the comparison contact. After the users decided on a position, they can click the left mouse button to insert the comparison contact.

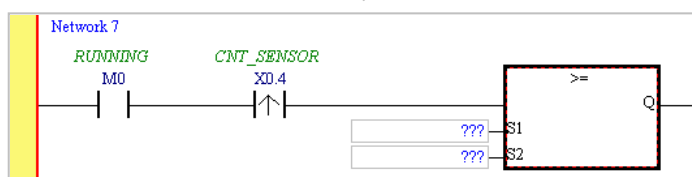
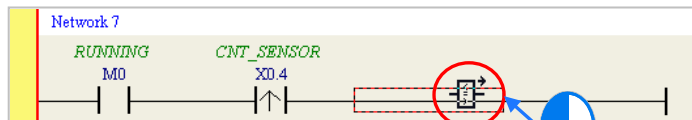

Write the program shown below in the way described above. In WPLSoft, a decimal value is preceded by K, and a hexadecimal value is preceded by H. If users want to type a decimal value in ISPSOft, they can type it directly. If users want to type a hexadecimal value in ISPSOft, they have to type "16#" and the hexadecimal value, e.g. 16#7FFF. In ISPSOft, an octal value is preceded by 8#, and a binary value is preceded by 2#.

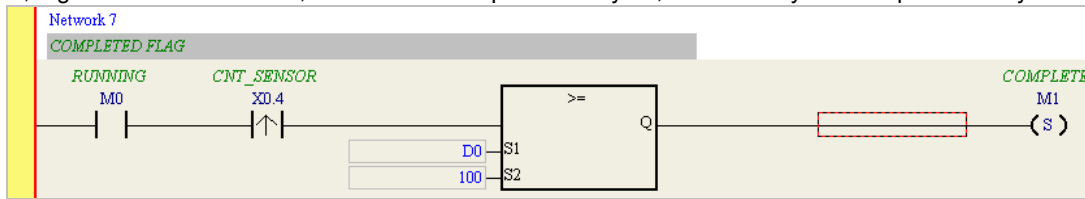

6.5.9 Writing a Program

The creation of a traditional ladder diagram in ISPSOft has been introduced. Users can write the program shown below in the way described in the previous sections. Owing to the fact that the program has not been compiled, the mother line at the left side of the ladder diagram is red during the writing of the program. The following sections will introduce how to compile the program, and how to download the program which has been compiled to the CPU module to test the program.

6

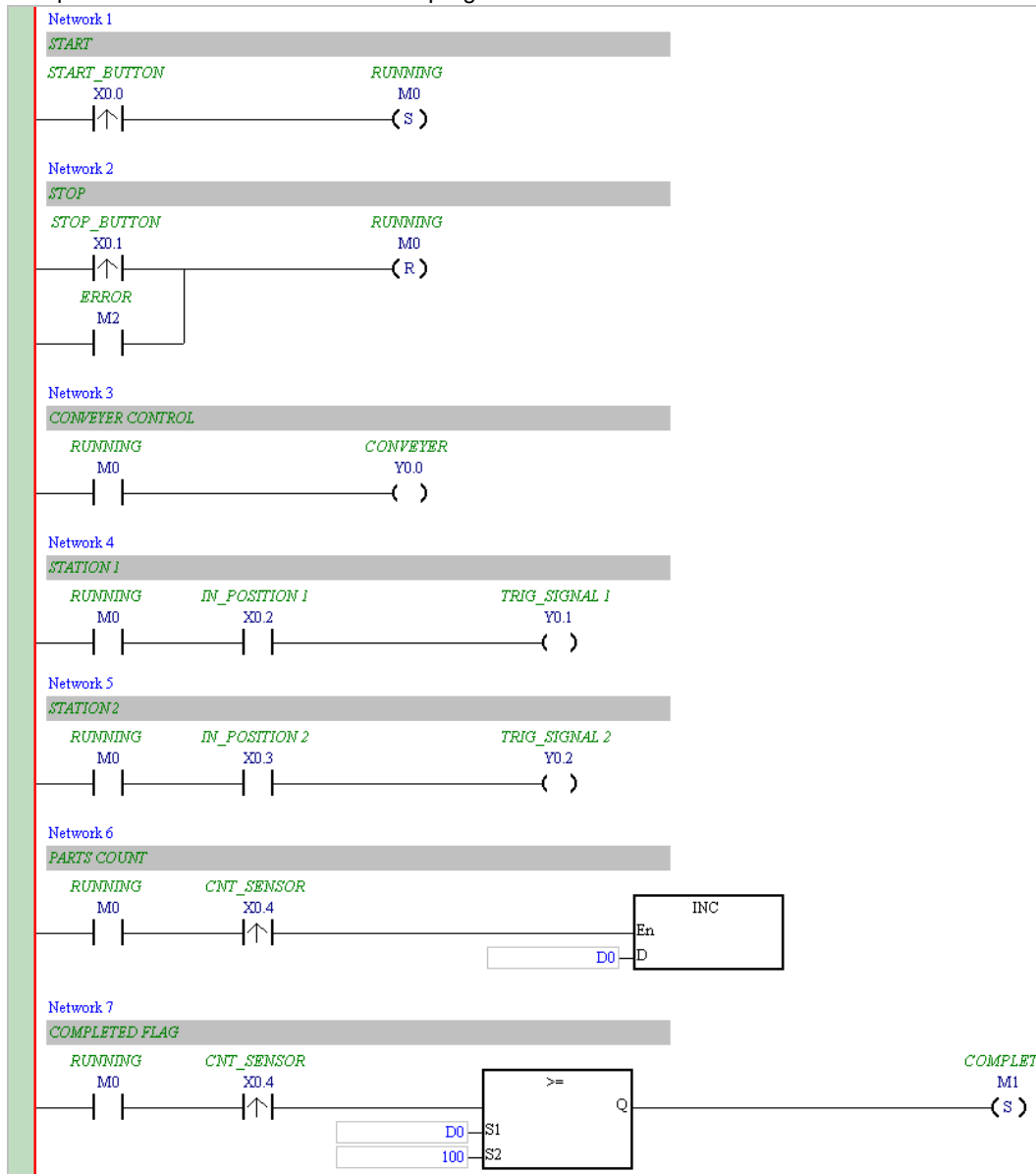

- *1. The program above is saved in the folder denoted by ...ISPSOft x.xx\Project\Example\Gluing_System_C.
- *2. Please refer to chapter 8 in ISPSOft User Manual for more information about creating a ladder diagram.

6.5.10 Checking and Compiling a Program

After users write a program, they can check the syntax of the programming language or compile the program. The syntax and the structure in the present window will be checked after the **Check** function is enabled. The whole project will be checked after the **Compile** function is enabled. If there is no error in the project, an execution code will be generated automatically. After the program is compiled successfully, the mother line at the left side of the ladder diagram will become black.

- **Check**

Click **Check** on the **Compile** menu, or  on the toolbar.

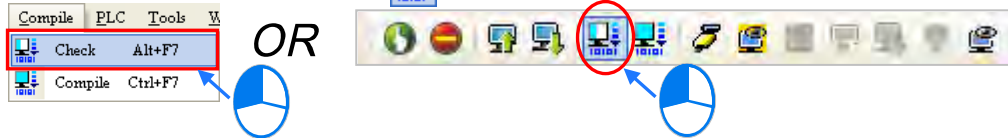

- **Compile**

Click **Compile** on the **Compile** menu, or  on the toolbar.



After the check is complete, the **Compile Message** page shows the result related to the check. If there is any error in the project, the **Compile Message** page will show the related message. After the message is clicked, the system will automatically lead users to the place where the error occurs. The users can enable the **Check** function or the **Compile** function after the error is eliminated.

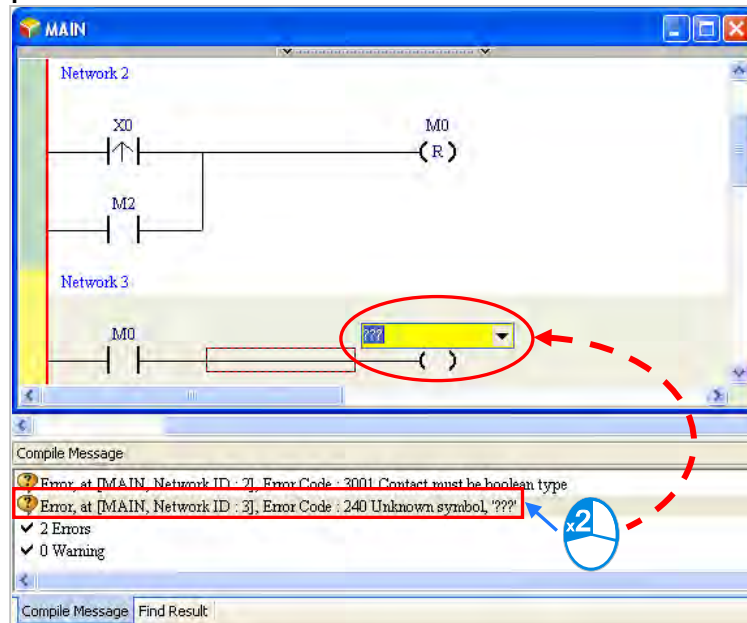

6

6.6 Testing and Debugging a Program

6.6.1 Creating a Connection

Before a program and parameters are downloaded to a PLC or monitored online, ISPSOFT must be connected to the PLC. In this example, ISPSOFT is connected to the CPU module AHCPU530-EN through a USB cable. Please refer to section 2.4 in ISPSOFT User Manual for more information about connecting ISPSOFT to a PLC in other ways. Please refer to operation manuals for more information about wiring.

Those who have connected ISPSOFT to a PLC successfully in accordance with the contents of section 2.4 in ISPSOFT User Manual can skip this section.

(1) Install the modules on the main backplane in accordance with the hardware configuration in HWCONFIG.

Make sure that the wiring is correct, and then power the CPU module.

- (2) Connect the CPU module to the computer through a USB cable. If the USB driver for the AH500 series CPU module has been installed on the computer, **Delta PLC** will appear in the **Device Manager** Window, and a port number will be assigned to **Delta PLC**. Please refer to appendix A for more information about installing a USB driver.
- (3) Make sure that COMMGR is started, and the icon representing COMMGR is displayed on the system tray. If the icon representing COMMGR is not displayed on the system tray, users can start COMMGR by clicking the shortcut on the **Start** menu (**Start>Programs>Delta Industrial Automation>Communication>COMMGR**).

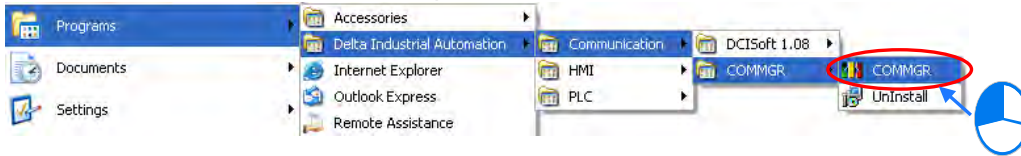

- (4) Double-click the icon representing COMMGR on the system tray to open the **COMMGR** window. Click **Add** in the **COMMGR** window to create a driver.

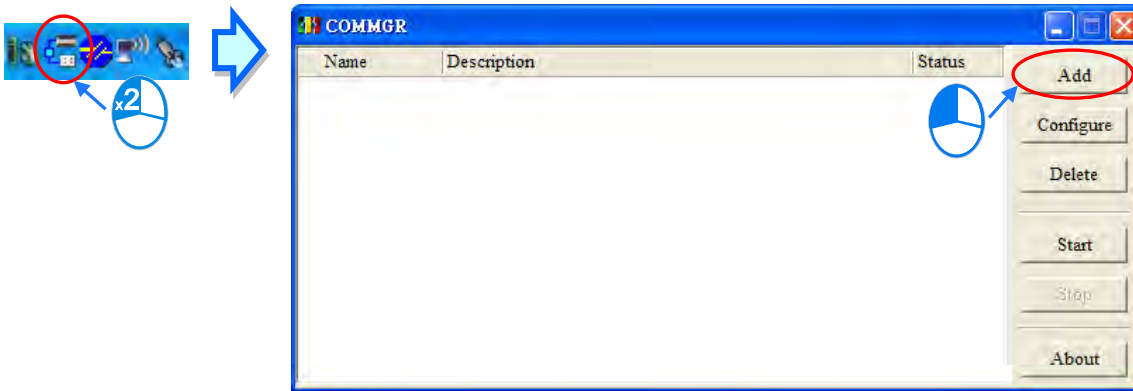

6

- (5) Set the parameters in the **Driver Properties** window, and then click **OK**.

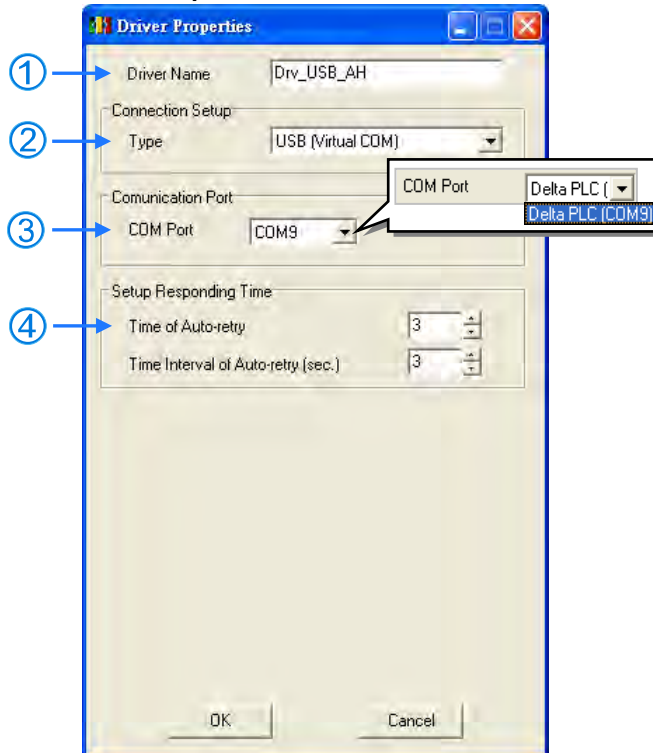

- ① Type a driver name in the **Driver Name** box.
 - ② Select **USB (Virtual COM)** in the **Type** drop-down list box in the **Connection Setup** section.
 - ③ Select a communication port in the **COM Port** drop-down list box. If the first two steps are complete, the PLC which is connected and its communication port will be displayed in the **COM Port** drop-down list box.
 - ④ Users can select the number of times the sending of a command is retried if a connection error occurs in the **Time of Auto-retry** box, and select an interval of retrying the sending of a command in the **Time Interval of Auto-retry** box.
- (6) Click the driver created in the **COMMGR** window, and then click **Start**. Start ISPSOft, and then click **Communication Settings...** on the **Tools** menu. In the **Communication Setting** window, select the driver which has been created in the **Driver** drop-down list box, appear, and select 0 in the **Station Address** drop-down list box, and click **OK**. The information about the driver will be displayed in the status bar in ISPSOft.

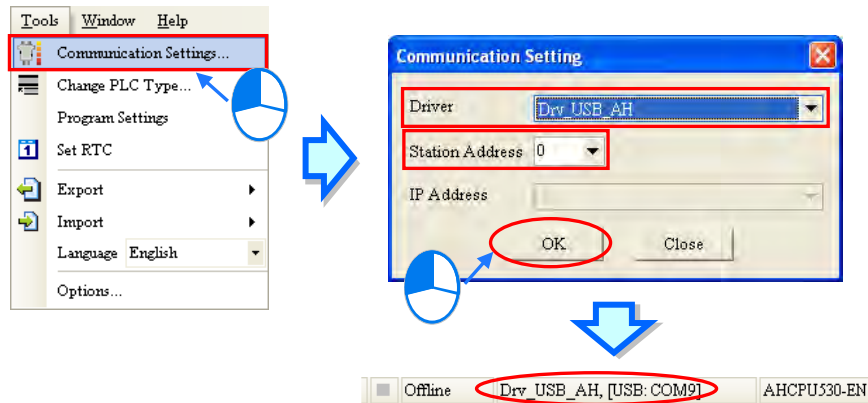

- (7) Click **System Information** on the **PLC** menu. ISPSOft will retrieve related information from the PLC. If the computer communicates with the CPU module normally, the related information retrieved from the PLC will be displayed in the **System Information** window.

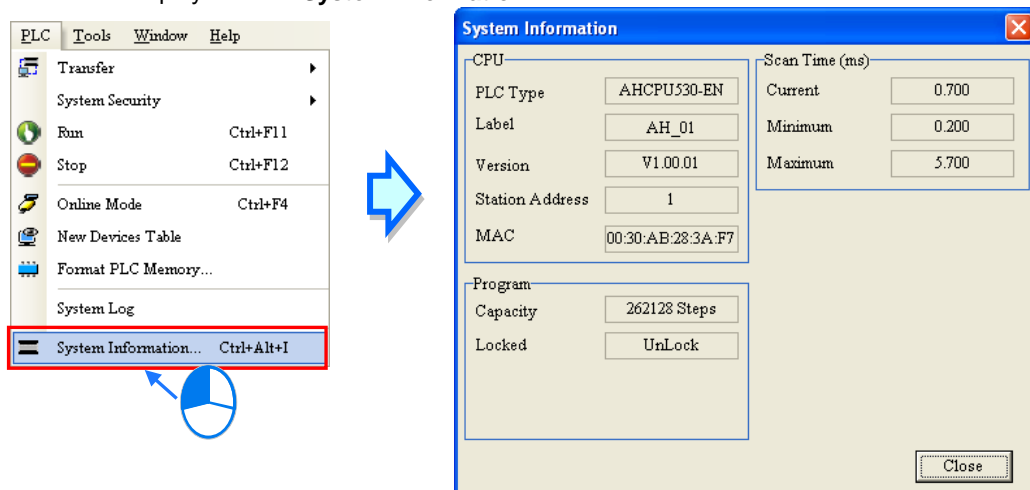

6.6.2 Downloading a Program and Parameters

If ISPSOft is connected to a PLC normally, the parameters and the program in the project can be downloaded to the PLC. First, start ISPSOft and open the project created in the previous sections. In this example, two types of parameters are downloaded to the CPU module. They are the hardware configuration and the program.

- **Downloading the hardware configuration**

- (1) Double-click **HWCONFIG** in the project management area to open the **HWCONFIG** window.

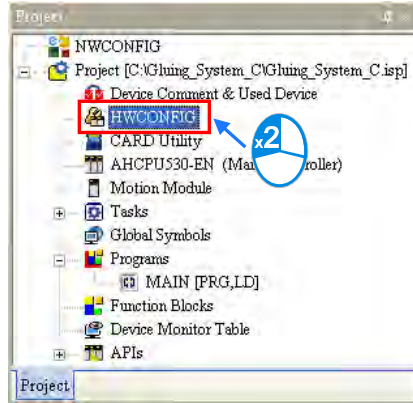

- (2) The hardware configuration is displayed in the window. Before the hardware configuration is downloaded to the CPU module, users have to make sure that the actual hardware configuration is the same as the hardware configuration in the window.

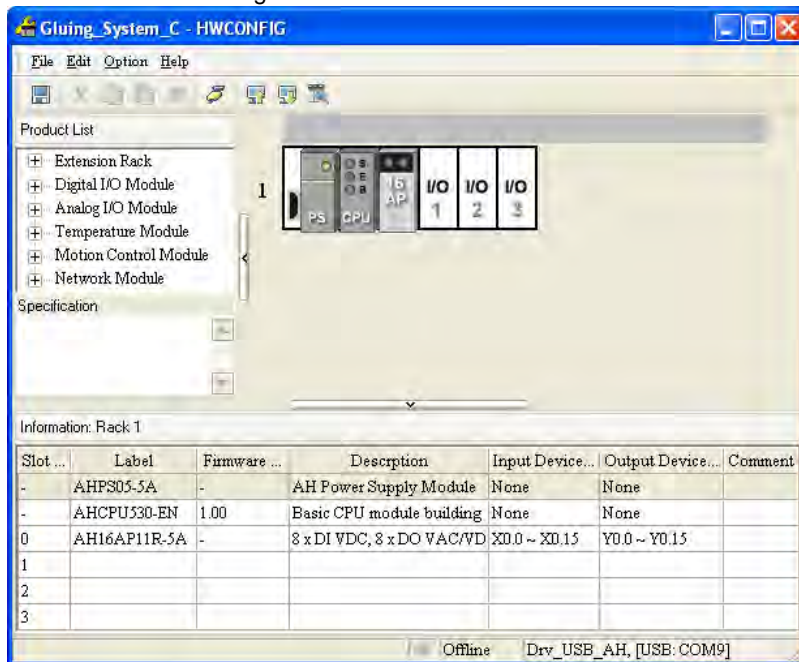

6

- (3) After the users click **Download** on the **Option** menu, or  on the toolbar, the **Transfer Items** window will appear. The hardware configuration will be downloaded to the CPU module after **OK** is clicked.

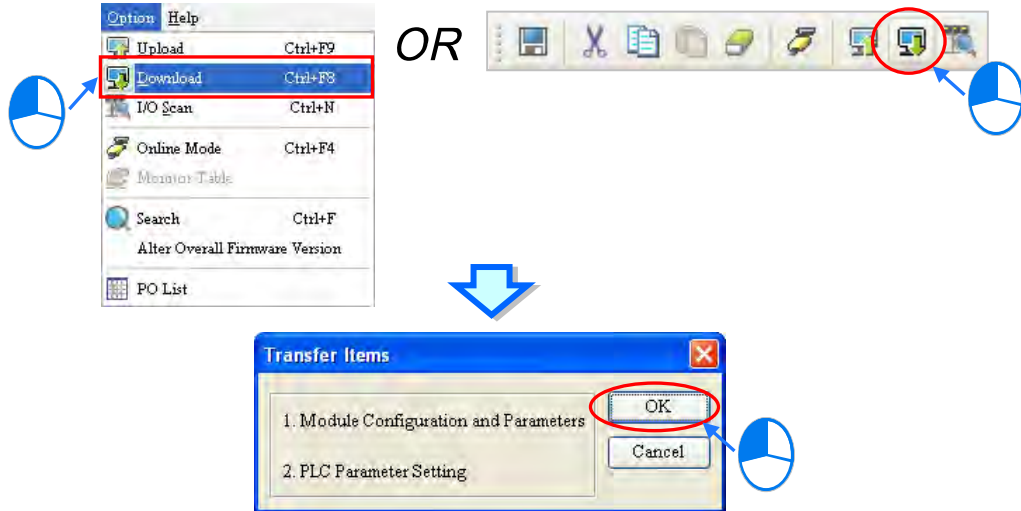

- (4) After the hardware configuration is downloaded to the CPU module successfully, the BUS FAULT LED indicator on the CPU module will be OFF. The users can close the **HWCONFIG** window. If the BUS FAULT LED indicator on the CPU module is still ON or blinking, the CPU module is in an abnormal state. Please make sure that the actual hardware configuration is the same as the hardware configuration in the **HWCONFIG** window again, or refer to the operation manual for more information about eliminating the error. Please refer to chapter 8 for more information about HWCONFIG.

● **Downloading the program**

After the program is compiled successfully, the users can click the **PLC** menu, point to **Transfer**, and click **Download**. The users can also click  on the toolbar after the program is compiled successfully. Select the **Program** checkbox and the **Comments** checkbox in the **Transfer Setup** window so that the program in the CPU module can be uploaded later, and then click **OK**.

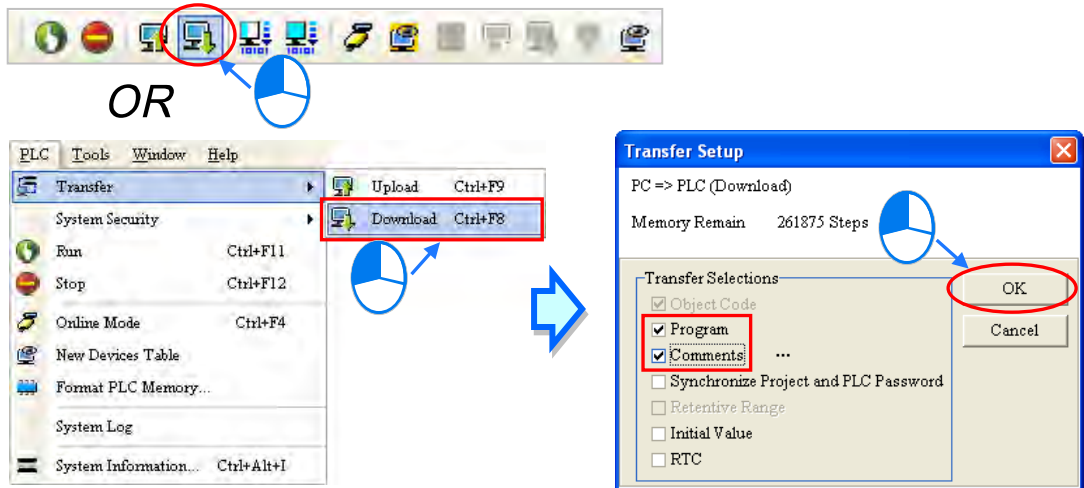

6

6.6.3 Connection Test

After a program is downloaded to a PLC, users can monitor the execution status of the PLC through ISPSOft. There are two monitoring modes that ISPSOft provide. One is the device monitoring mode, and the other is the program monitoring mode.

Monitoring mode	Description
 Device monitoring mode	Users can monitor the statuses of the devices in the PLC through the monitoring table. In this mode, ISPSOft only needs to update the statuses of the devices. The present program in ISPSOft does not need to be the same as the program in the PLC.

Monitoring mode	Description
 Program monitoring mode	In this mode, the operating status of the program is displayed in the program editing window. As a result, the present program in ISPSOft must be the same as the program in the PLC.

*. The device monitoring function can be enabled independently. However, if the program monitoring function is enabled, the device monitoring function is also enabled.

After users click **Online Mode** on the **PLC** menu, or  on the toolbar, the online monitoring function will be enabled. The system will also enable the device monitoring mode and the program monitoring mode.

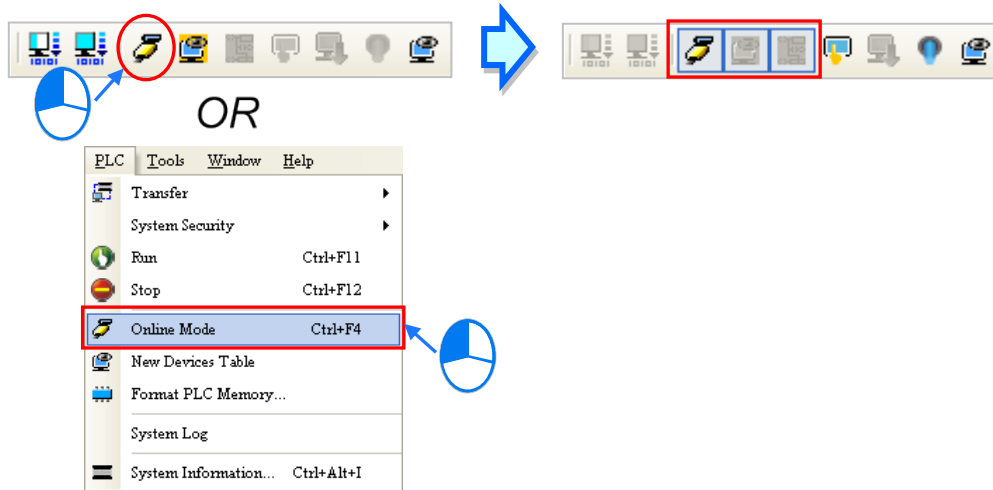



In the online monitoring mode, users can view the present scan time, the communication status, and the status of the PLC in the status bar in ISPSOft.

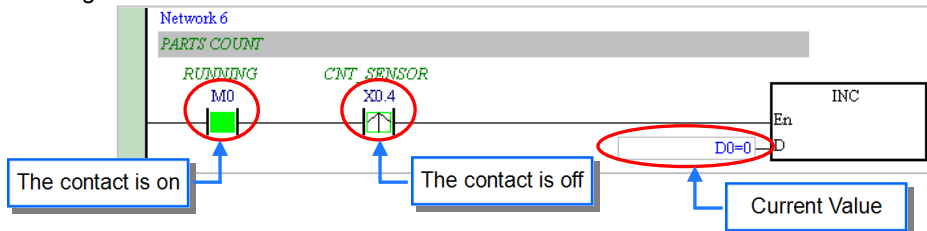

6

Besides, the present statuses of the devices will be displayed in the original program editing window after the program monitoring function is enabled.



Users can change the operating status of a PLC by the RUN/STOP switch on the PLC. They can also change the operating status of the PLC through the functions provided by ISPSOft. After users click **Run** on the **PLC** menu or  on the toolbar, the PLC will begin to run. The PLC will stop running after **Stop** on the **PLC** menu or  on the toolbar is clicked.

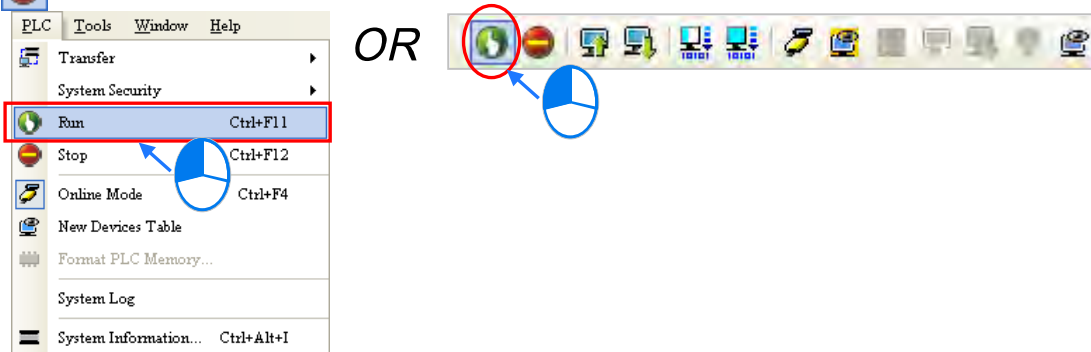

In the online monitoring mode, users can select a device, right-click the device, and click an item on the context

menu. During a test, users can change the status of a device or the value in a device by clicking an item on the context menu.

⚠ Before the status of a device is changed, users have to make sure that the operation does not cause damage to the system or staff.

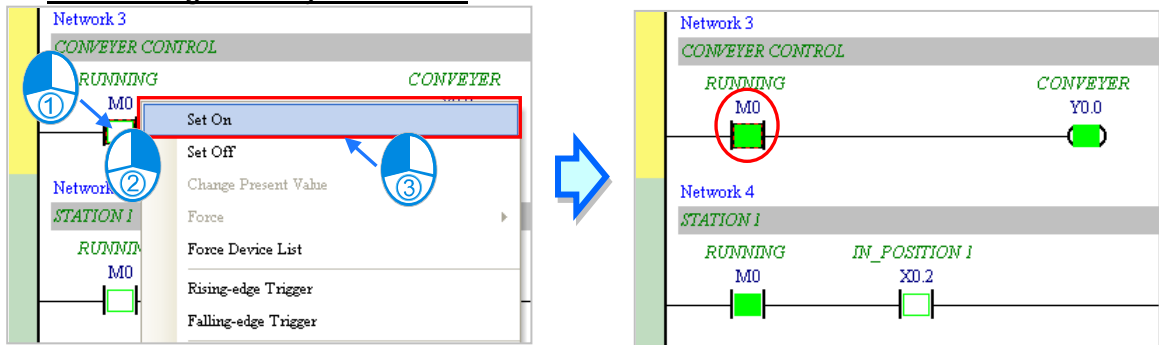

The items on the context menu are described below. **Force** on the context menu only applies to input contacts and output contacts.

Item	Description
Set On	Setting the contact selected to ON
Set Off	Setting the contact selected to OFF
Rising-edge Trigger	No matter what the state of the contact selected is, the system set the contact to OFF, and then set it to ON.
Falling-edge Trigger	No matter what the state of the contact selected is, the system set the contact to ON, and then set it to OFF.
Force	Forcing an input contact or output contact ON or OFF
Force Device List	Forcing several input contacts or output contacts in the tables ON or OFF

If users want to change the value in a device, they can click the device, right-click the device, click **Change Present Value** on the context menu, and set a present value in the **Enter Present Value** window.

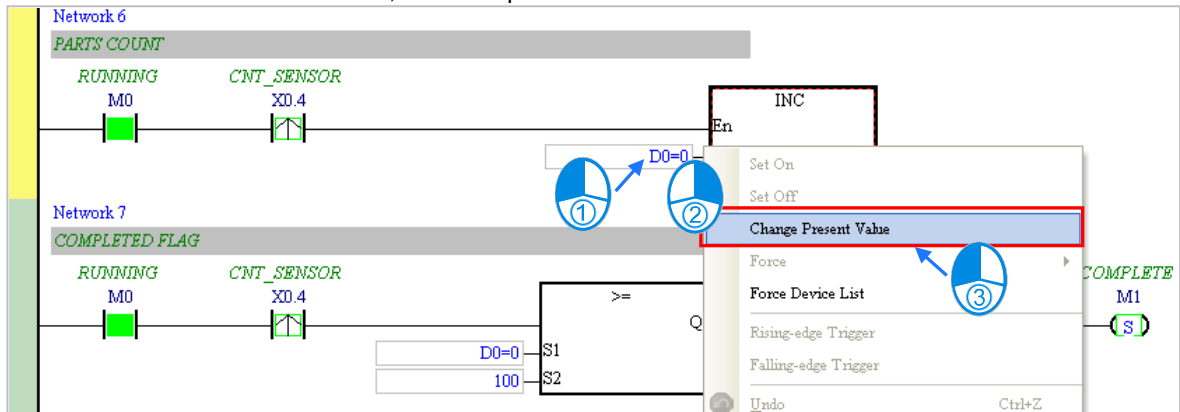

6

The **Enter Present Value** window is described below.

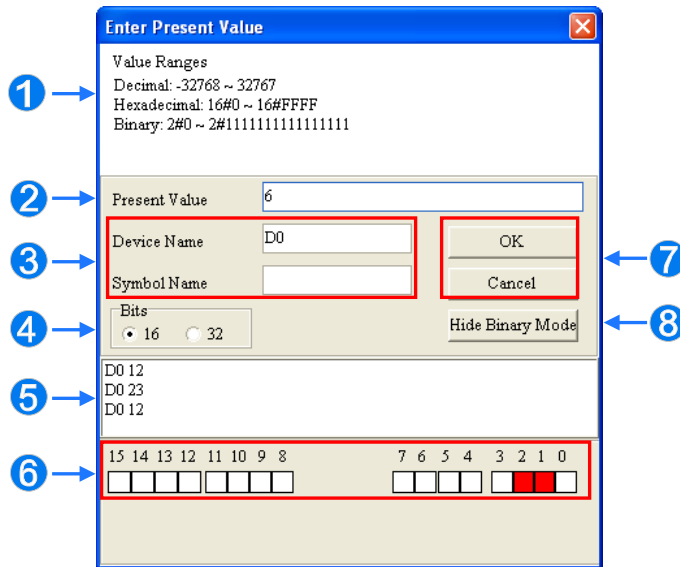

- ❶ Message
- ❷ Users can type a value in the **Present Value** box.
- ❸ Name of a device or a symbol whose present value will be changed
- ❹ Users can type a 16-bit value or a 32-bit value.
- ❺ Value change history (Format: Device name Value)
- ❻ In the binary mode, users can set the states of the bits through the mouse.
- ❼ The setting values will be applied after **OK** is clicked. The window will be closed after **Cancel** is clicked.
- ❽ Users can display or hide the binary mode.

In this example, X0.0~X0.15 and Y0.0~Y0.15 are input devices and output devices assigned to the digital I/O module AH16AP11R-5A. After the parameters in the hardware are downloaded to the CPU module, the states of X0.0~X0.15 will be the same as the states of the inputs on the actual module. Even if users set X0.0~X0.15 to ON or OFF in the program editing window, the states of X0.0~X0.15 will be updated by the actual input signals.

6



However, an input contact can be forced ON or OFF during a test. Users can click an input contact or output contact which will be set, right-click the contact, point to **Force** on the context menu, and select **On (X/Y)**, **Off (X/Y)**, **Release (X/Y)**, or **Release All**. If an input contact or output contact is forced ON or OFF, a lock symbol will appear at the left side of the contact.

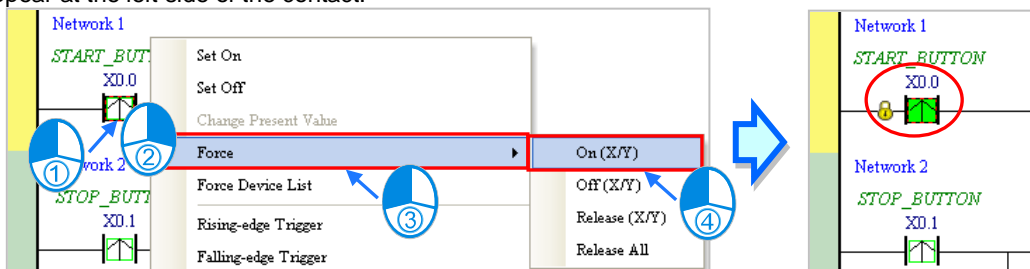

Force	Description
On (X/Y)	Forcing the input contact or output contact selected ON

Force	Description
Off (X/Y)	Forcing the input contact or output contact selected OFF
Release (X/Y)	Releasing the contact from the locked state
Release All	Releasing all the contacts from the locked states

If an output contact in the program is forced ON or OFF, the output state of this contact will not be affected by the program execution result.



*. If the online monitoring function is disabled, the contacts will not be automatically released from the locked states. As a result, users have to check whether the contacts need to be released from the locked states after the test is complete.

There are two ways to create a monitoring table. Users can create a monitoring table online or offline.

● **Method 1**

Click **New Devices Table** on the **PLC** menu, or  on the toolbar.

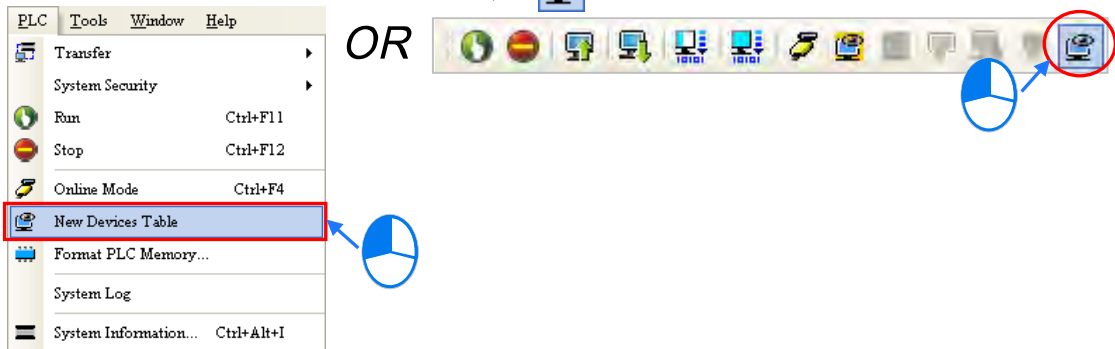

● **Method 2**

Right-click **Device Monitoring Table** in the project management area, point to **Device Monitor** on the context menu, and click **Add**.

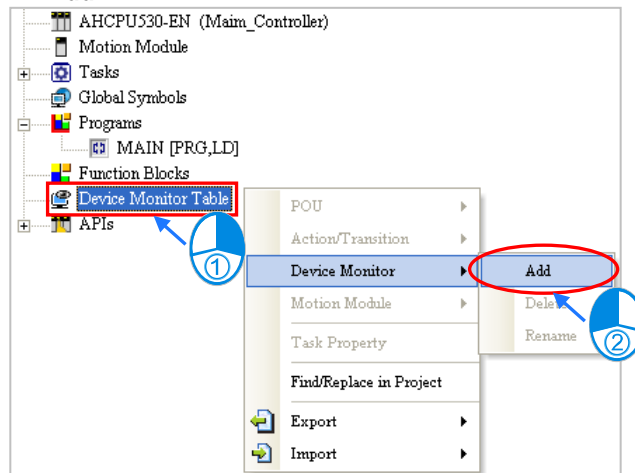

Type a table name in the **Add Monitor Table** window, and then click **OK**. An item will be under **Device Monitor Table** in the project management area. If users want to open the monitoring table, they can double-click the item. Besides, the users can create several monitoring tables in the project, and the monitoring tables created will be saved with the project.

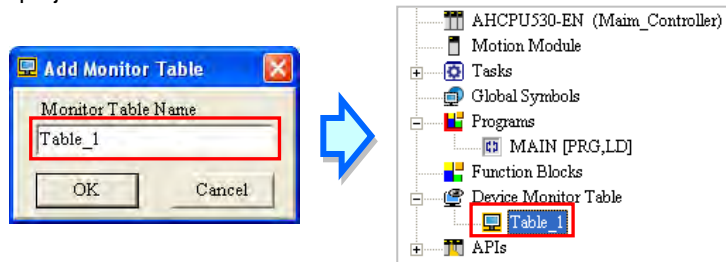

After the item is double-clicked, a window will appear. The users can add items which will be monitored to the window. If the users want to add an item to the window, they have to double-click the blank in the monitoring table, or type a device name directly, and type a start address and the number of devices which will be monitored in the **Device Monitor Input** window. Please notice that 100 items at most can be added to a monitoring table.

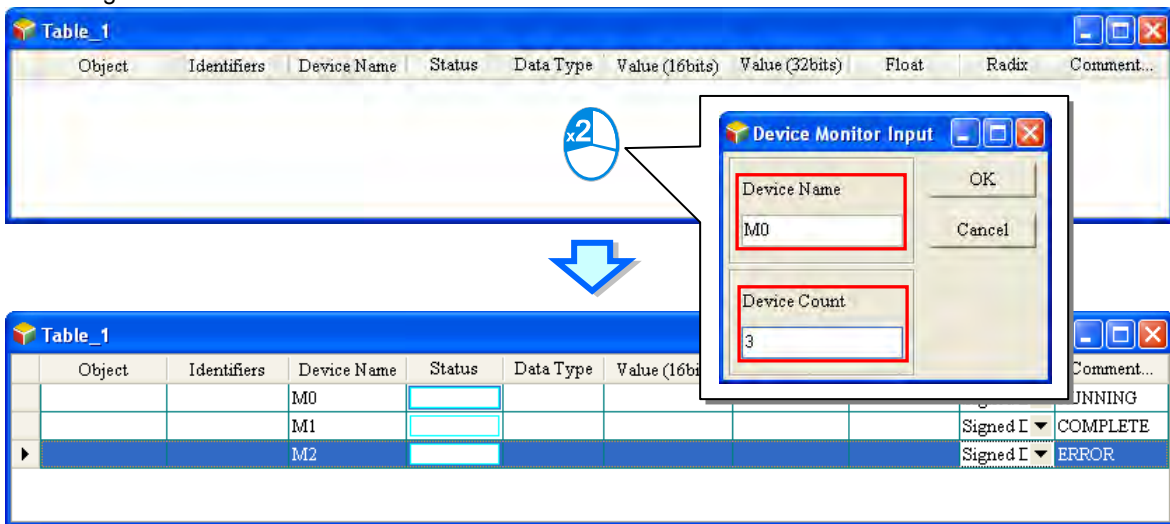

6

The users can press Insert on the keyboard to switch between inserting an item in the monitoring table and replacing an item in the monitoring table. The mode which is selected is displayed in the status bar in ISPSOft. If the insertion mode is selected, the item added will be above the item selected in the monitoring table. If the replacement mode is selected, the item added will overwrite the item selected in the monitoring table.



If the users want to hide certain columns in the monitoring table, they can right-click the monitoring table, point to **Set the Fields**, and unselect certain items. After an item is unselected, the corresponding column will disappear.

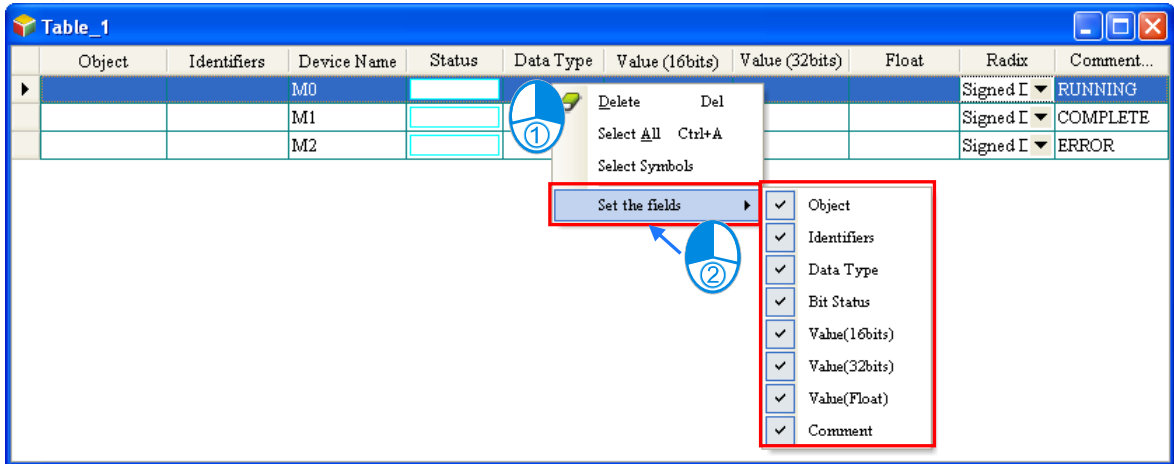

The description of the columns in the monitoring table is as follows.

Column	Description
Source	The source of a symbol
Identifier	The identifier of a symbol
Device name	The name of a device monitored
Status	If a bit device or a contact is monitored, the state will be ON or OFF.
Data type	If a symbol is monitored, the data type of the symbol will be displayed.
Value (16 bits)	In the online mode, a 16-bit value is displayed.
Value (32 bits)	In the online mode, a 32-bit value is displayed.
Float	In the online mode, a 32-bit floating-point number is displayed.
Radix	Users can select a format in which a value is represented.
Comment	The comments on a device or the comment on a symbol is displayed.

After the monitoring table is created, the users can monitor the items in the monitoring table in the online mode. Besides, after the users right-click an item in the monitoring table in the online mode, a context menu which is the same as the context menu which will appear after a device in the program editing window is clicked will appear. The users can change the state of the item or the value in the item by clicking an item on this context menu.

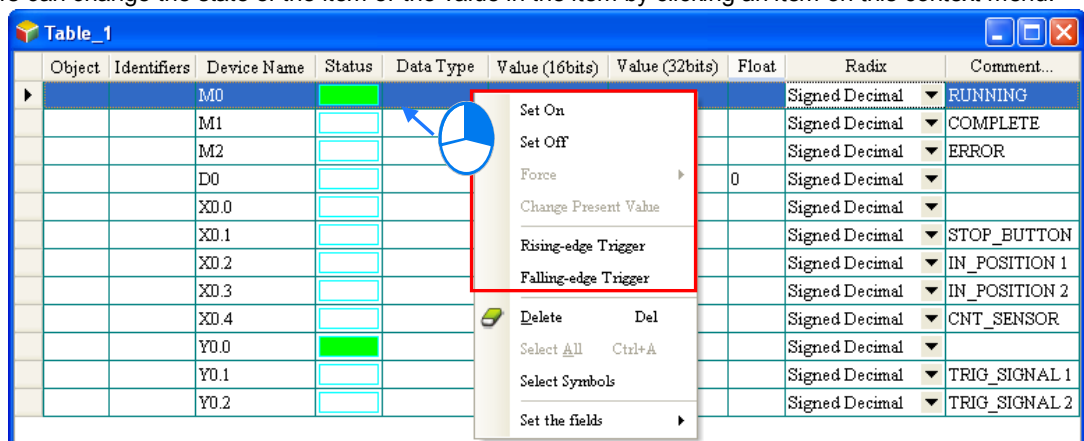

The program created in this chapter can be tested and debugged through the monitoring table created in this section. Please refer to chapter 14 in ISPSOFT User Manual for more information about testing and debugging a program.

6.7 Setting a Real-time Clock

After an AH500 series CPU module is connected to a computer, users can set the real-time clock in the CPU module through ISPSOft.

- (1) Click **Set RTC** on the **Tools** menu.

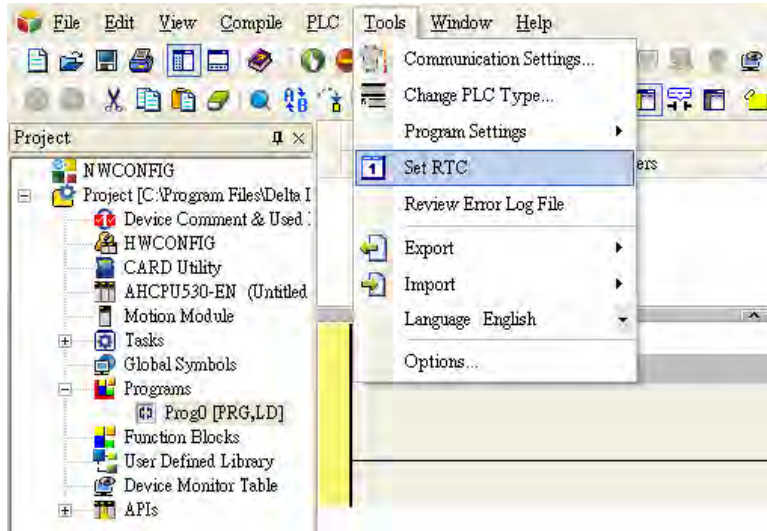

- (2) Select **Computer**, and then click **Synchronize**.

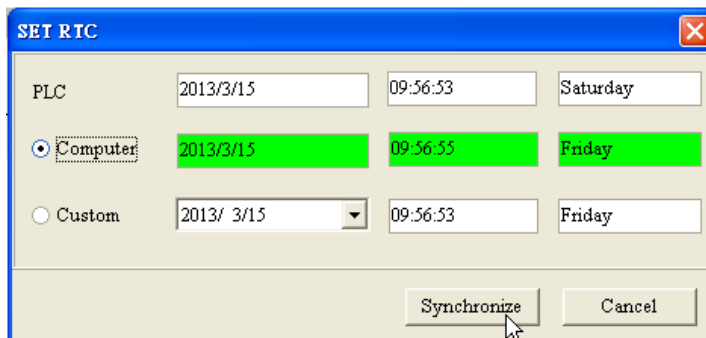

- (3) The setting of the real-time clock is complete.





Chapter 7 Memory Card

Table of Contents

7.1	Overview of Memory Cards	7-2
7.1.1	Appearances of Memory Cards.....	7-2
7.1.2	Specifications for SD Cards	7-2
7.2	Using a Memory Card.....	7-3
7.2.1	Formatting a Memory Card	7-3
7.2.2	Write Protect Function of a Memory Card	7-4
7.3	Installing and Removing a Memory Card	7-5
7.3.1	SD Slot in a CPU Module.....	7-5
7.3.2	Installing a Memory Card	7-6
7.3.3	Removing a Memory Card	7-6
7.4	Contents of a Memory Card.....	7-6
7.4.1	Initializing a Memory Card.....	7-6
7.4.2	Folder Structure in a Memory Card	7-7
7.5	Reading/Writing a Memory Card.....	7-7
7.5.1	Backing up the System	7-7
7.5.2	Restoring the System.....	7-8
7.6	Introduction of CARD Utility	7-9
7.7	Backup	7-11
7.8	Restoration	7-14

7.1 Overview of Memory Cards

The AH500 series CPU modules support standard SD cards. Users can purchase products which meet specifications. The specifications for the SD cards supported by the AH500 series CPU modules, and the usage of the SD cards are described in this chapter.

7.1.1 Appearances of Memory Cards

SD cards are classified into three types according to size. They are SD cards, miniSD cards, and microSD cards. The AH500 series CPU modules support standard-sized SD cards.

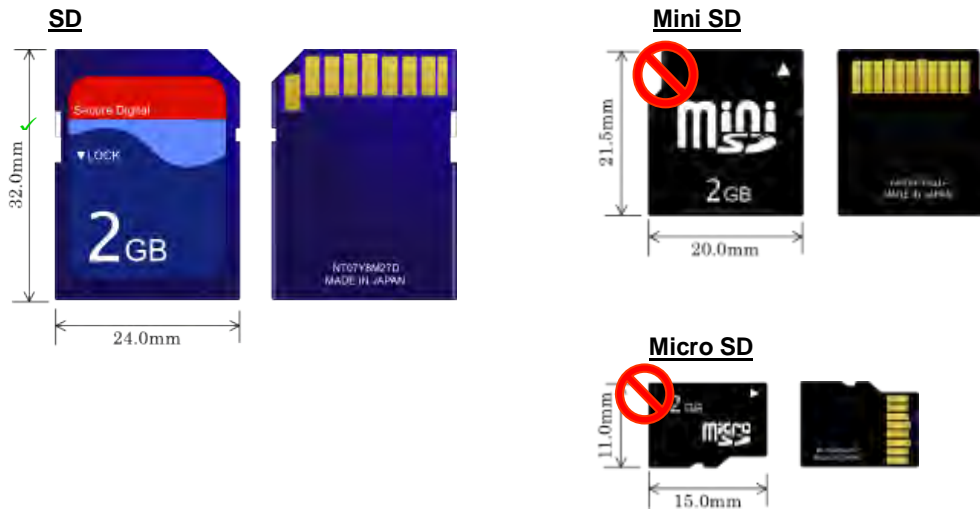

7.1.2 Specifications for SD Cards

There are several specifications for SD cards on the market. SD cards not only can be classified according to size, but also can be classified into three types according to capacity. These types are SD cards, SDHC cards, and SDXC cards. The AH500 basic series CPU modules presently support SD cards up to 2GB and the AH500 advanced series CPU modules presently support SDHC cards up to 32GB. The following is the table of SD card families. The SD column indicates the specifications supported by the AH500 basic series CPU modules and the SDHC column indicates the specifications supported by the AH500 advanced series CPU modules. Be sure to purchase products which meet the specifications.

- The SD card families

Type	SD	SDHC			SDXC	
Capacity	2GB Max.	4GB ~ 32GB			32GB ~ 2TB	
File system	FAT/FAT32	FAT32			exFAT	
Size	SD	SDHC	MiniSDHC	MicroSDHC	SDXC	MicroSDXC
Speed class rating	N/A	Class 2 (Min. 2 MB/sec.) Class 4 (Min. 4 MB/sec.) Class 6 (Min. 6 MB/sec.) Class 10 (Min. 10 MB/sec.)			Class 2 (Min. 2 MB/sec.) Class 4 (Min. 4 MB/sec.) Class 6 (Min. 6 MB/sec.) Class 10 (Min. 10 MB/sec.)	

* MMC cards are similar to SD cards in appearance. Users have to make sure that they purchase products which meet the specifications.

7

7.2 Using a Memory Card

7.2.1 Formatting a Memory Card

A memory card that users use for the first time may not be formatted. A memory card which is not formatted can not be used in an AH500 series CPU module. Therefore, users need to format the memory card. The file system with which the memory card is formatted is FAT.

The following example introduces the most common way to format an SD card, that is, formatting an SD card through a card reader. However, users still need to read the documents provided by the SD card manufacturer carefully.

⚠ If a memory card is formatted, all the data in the memory card will be deleted. Users have to check whether the data in a memory card needs to be backed up before they format the memory card.

- (1) Slide the write protect tab on the left side of the memory card upward, and then insert it into a card reader. The operating system detects a new storage device.

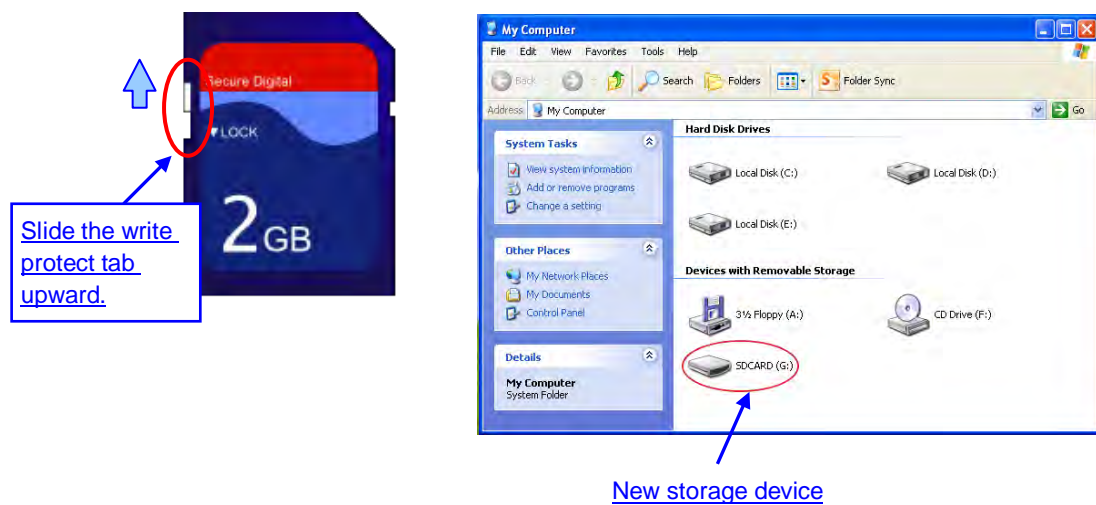

- (2) Right-click the new storage device, and then click **Format**.

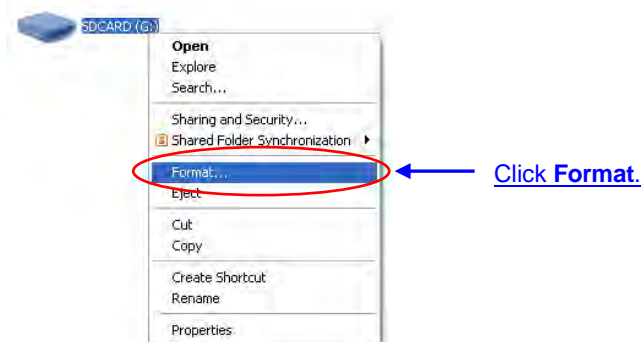

- (3) The file system with which the memory card is formatted must be FAT. The other default setting is retained. Click **Quick Format**, and then click **Start**.

7

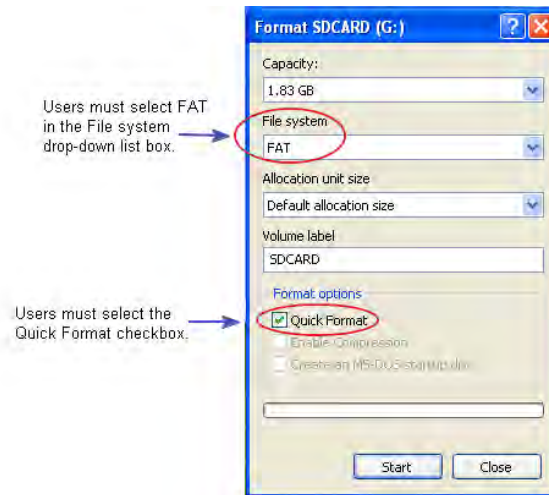

(4) After **OK** in the warning window is clicked, the SD card is formatted.

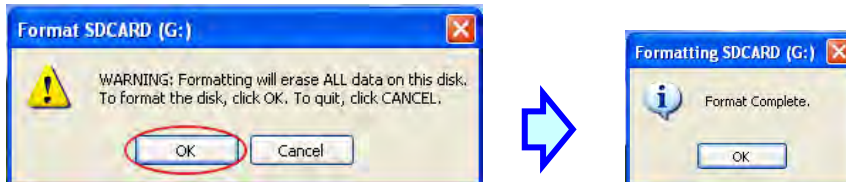

7.2.2 Write Protect Function of a Memory Card

There is usually a write protect tab on the left side of a memory card. If the tab is slid downward, data can not be written into the memory card. As a result, users have to make sure that the tab is slid upward before they use the memory card.



7

7.3 Installing and Removing a Memory Card

7.3.1 SD Slot in a CPU Module

As shown below, the SD slot is in the lower right corner of the front of a CPU module.

AHCPU500/510/511/520/530-RS

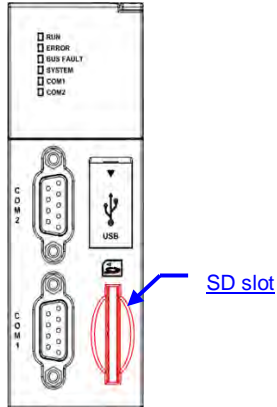

AHCPU500/510/511/520/521/530/531-EN

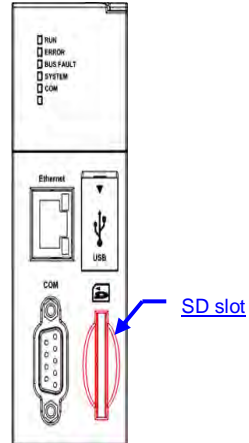

AHCPU530-RS2

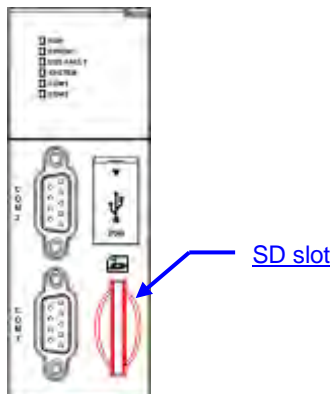

AHCPU530-EN

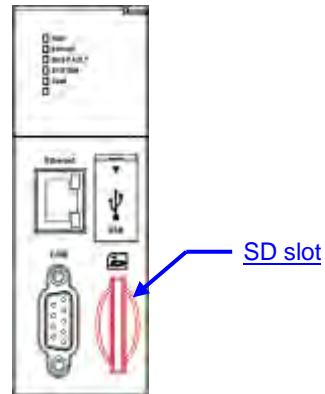

7.3.2 Installing a Memory Card

Insert a memory card into the SD slot in a CPU module, and push it downward until it clicks. After the memory card is installed, it is fixed firmly in the slot. If the memory card is loose, it is not installed correctly. Besides, the memory card has anti-misinsertion design. If it is inserted in the wrong direction, it can not be pushed downward. To prevent the CPU module from being damaged, users can not force the memory card in. The correct way to insert the memory card is shown below.

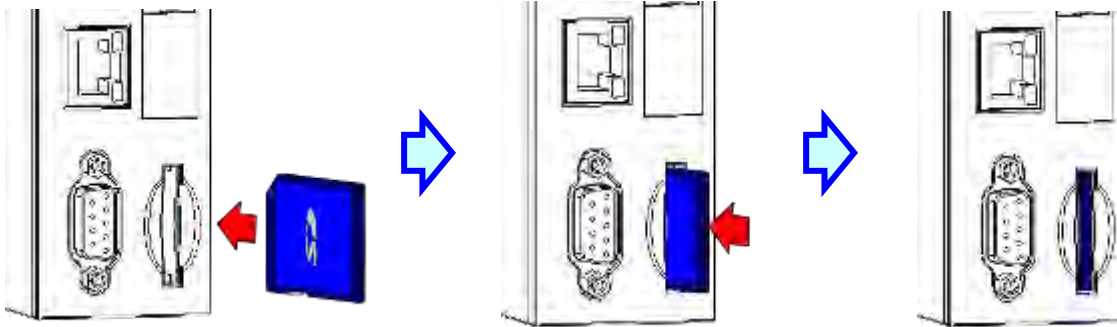

7.3.3 Removing a Memory Card

After a memory card is pushed downward, it springs from the slot, and users can take it out.

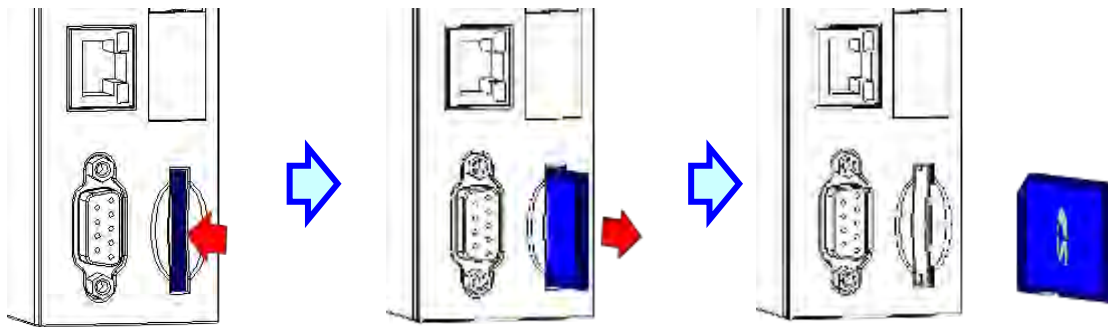

7.4 Contents of a Memory Card

7.4.1 Initializing a Memory Card

7

Whenever an SD card is inserted into a CPU module which is supplied with power, or power is supplied to a CPU module into which an SD card has been inserted, the system initializes the SD card, and a default folder created in the SD card is named according to the model of the CPU module.

During the initialization of a SD card, if a folder is missing from the default folder group, the system automatically adds the lost folder. However, if the initialization of a SD card fails, the SD card can not be initialized again until it is formatted again.

When a memory card is initialized, the SYSTEM LED indicator blinks.

7.4.2 Folder Structure in a Memory Card

The default folder group created by an AH system is shown below. The folder name is AH500. Several subfolders are contained inside the AH500 folder. Related files created by users and the AH system are stored in the subfolders.

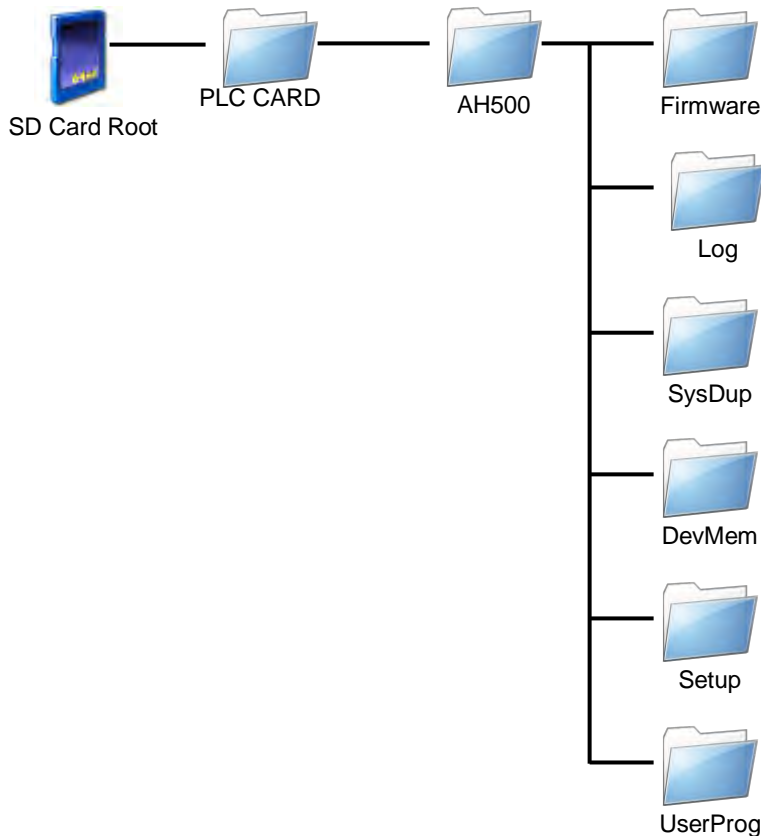

Folder	Description
Firmware	Used for storing firmware files (.mot), (.bin)
Log	Used for storing Log files (.log)
SysDup	Used for storing backup files (.dup)
UserProg	Used for storing device memory files (.txt, .dmd, .csv)
DevMem, Setup	Reserved for the system

7

7.5 Reading/Writing a Memory Card

Users can read/write data into/from a memory card to back up and update a system by means of the DIP switch on a CPU module.

7.5.1 Backing up the System

When a system backup is executed, the user program, the parameter setting, the hardware configuration, the network configuration, and the values on the device memories in a CPU module are backed up and saved as a file called AUTOEXEC.dup, which is stored in a folder named SysDup in a memory card. If a default path denotes an existing backup file, the previous data in the old backup file is overwritten when a system is backed up.

A system backup can be executed, whether a CPU module runs or stops. However, users have to make sure that the write protect tab on the left side of a SD card is slid upward before a system backup is executed. The system backup procedure is as follows.

- (1) Turn DIP switch 3 ON, and turn the other switches OFF. If users do not want to back up the values on the device memories, they need to turn DIP switch 4 ON.

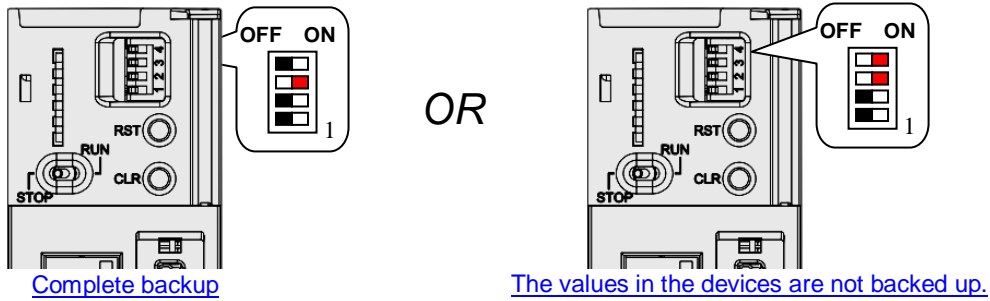

- (2) Press the CLR button on the CPU module for five seconds. When the system backup is executed, the SYSTEM LED indicator blinks. After the system backup is complete, the SYSTEM LED indicator is OFF.

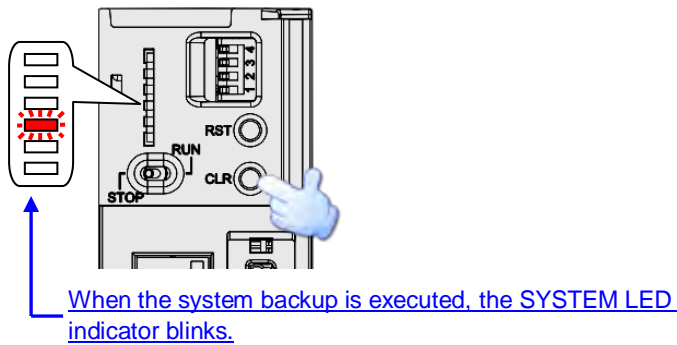

7.5.2 Restoring the System

7

Before a system restoration is executed, users have to make sure that the backup file AUTOEXEC.dup is stored in a folder named SysDup in a memory card. After the system restoration is executed, the user program, the parameter setting, the hardware configuration, and the network configuration in the memory card are restored to a CPU module. In addition, if the data in the backup file includes the values on the device memories, the data restored to the CPU module will include the values on the device memories.

Before a system restoration is executed, users have to disconnect a CPU module. The system backup procedure is as follows.

- (1) Make sure that the CPU module is disconnected, turn DIP switch 2 ON, and turn the other switches OFF.

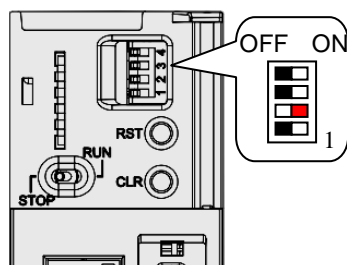

- (2) Restore the power supply. After the system detects that DIP switch 2 is ON, the system restoration is executed. When the system restoration is executed, the SYSTEM LED indicator blinks. After the system restoration is complete, the SYSTEM LED indicator is OFF.

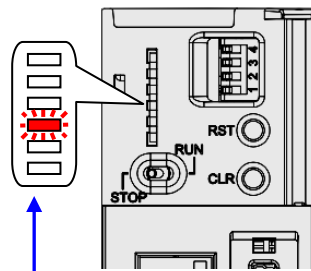

When the system restoration is executed, the SYSTEM LED indicator blinks.

- * Whenever power is supplied to a CPU module, the system checks the state of DIP switch 2. If DIP switch 2 is turned ON, a system restoration is executed automatically. As a result, users must turn DIP switch 2 OFF after a system restoration is complete. In addition, the hardware configuration and the backplanes which are involved in a system restoration must be the same as those previously involved in the system backup in order to prevent an error from occurring.

7.6 Introduction of CARD Utility

There are SD slots on AH500 series CPU modules. Users can back up/restore data in an AH500 series CPU module through the use of a memory card. Besides, ISPSOft provides CARD Utility for AH500 series CPU modules. The users can back up/restore data in an AH500 series CPU module or an ISPSOft project through a wizard. The program code, the parameter setting, the hardware configuration, and the network configuration in an AH500 series CPU module or an ISPSOft project can be backed up. The values in the devices in an AH500 series CPU module can also be backed up. Please refer to operation manuals or technical documents for more information about the specifications of the SD cards which can be inserted into AH500 series CPU modules, and the usage of the SD cards.

The hardware configuration stored in an AH500 series CPU module is data which is only related to the AH500 series CPU module itself. If users want to back up a hardware configuration, only the part of the network configuration which is related to the AH500 series CPU module selected will be backed up. The part of the network configuration backed up consists of a routing table and an Ether Link. Likewise, if the users want to restore data backed up to an ISPSOft project, there will be no network configuration in the ISPSOft project. Please refer to chapter 9 for more information about a network configuration.

The functions supported by CARD Utility are described below. The diagram below is a flowchart.

- If users export data in an AH500 series CPU module as a backup file (*.dup), the data exported can be saved in the memory card inserted in the AH500 series CPU module, or a folder in the computer. The users can decide whether to back up the values in the devices in the AH500 series CPU module.
- If users export an ISPSOft project for an AH500 series CPU module as a backup file (*.dup), the ISPSOft project exported can only be saved in a folder in the computer, and the values in the devices in the AH500 series CPU module are not backed up.
- Users can put the backup file saved in the memory card inserted in an AH500 series CPU module into the AH500 series CPU module.
- Users can put a backup file (*.dup) saved in a computer into the AH500 series CPU module connected to the computer, or restore the backup file to an ISPSOft project. If the users choose to restore the backup file to an ISPSOft project, the system will automatically skip the values in the devices and the hardware configuration in the backup file.

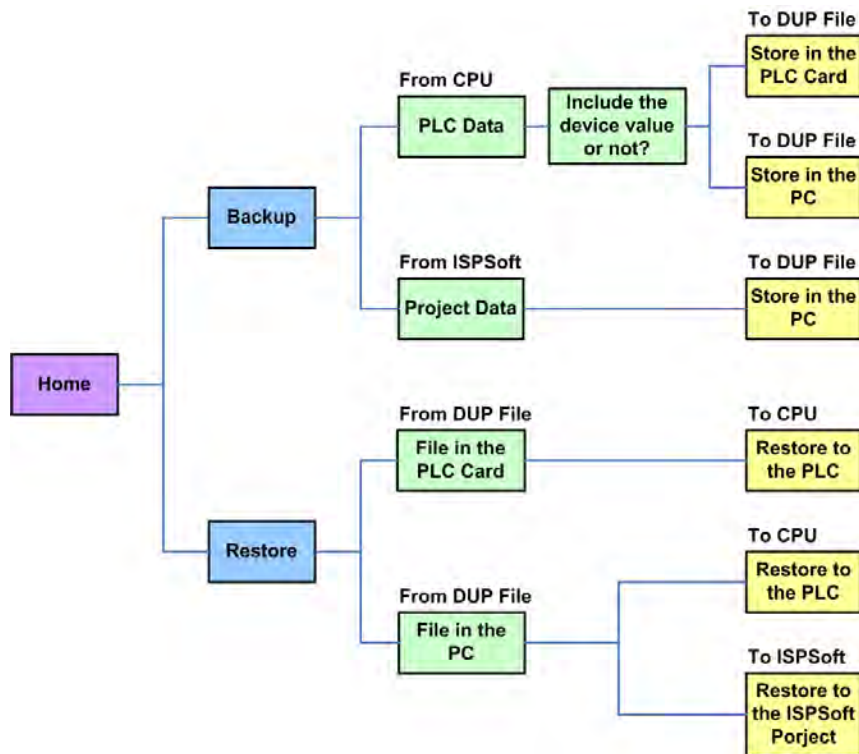

After users double-click **CARD Utility** in the project management area, the system will open the **CARD Utility** window.

7

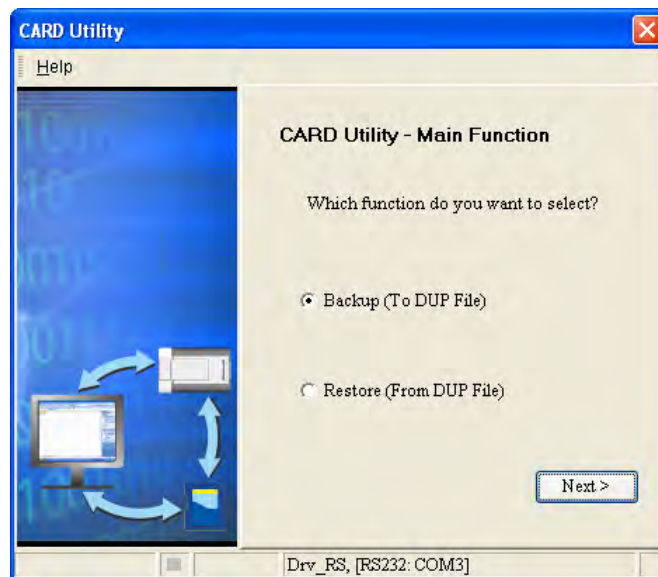
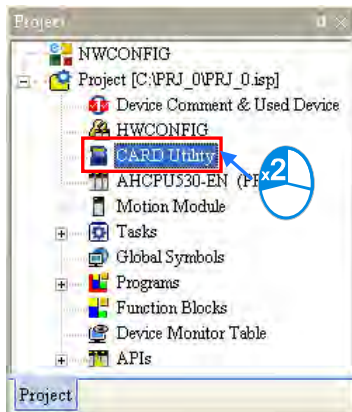

7.7 Backup

If the backup source/backup destination is an AH500 series CPU module or the memory card inserted in an AH500 series CPU module, users have to make sure that ISPSOft is connected to the AH500 series CPU module normally. Please refer to section 2.4 in ISPSOft User Manual for more information.

- (1) Select the **Backup (To DUP File)** option button in the **CARD Utility** window, and then click **Next**.

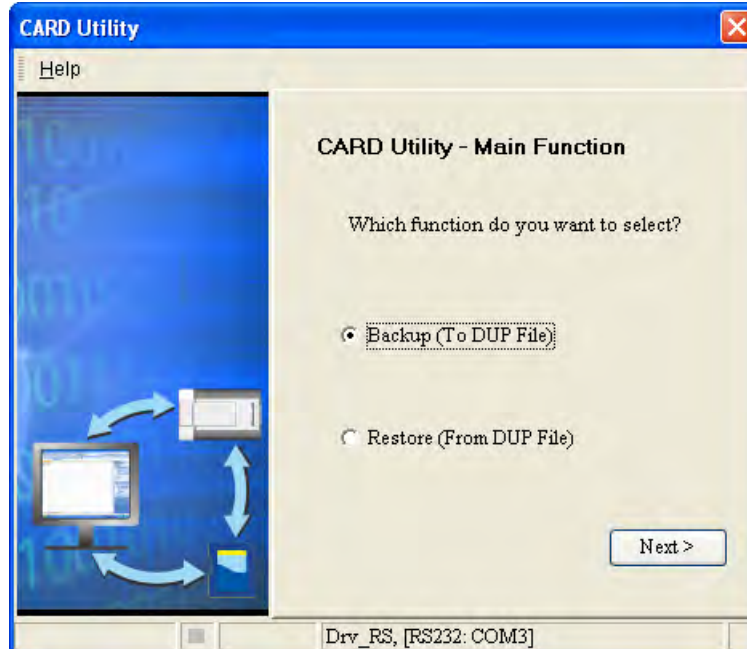

- (2) Select a backup source, and then click **Next**.

After the users select the **ISP Project (Compiled and saved)** option button, they have to click **...**, and select an isp file in the **Open** window. If the program in the isp file selected is not compiled, a message appears when the isp file is backed up. Open the isp file with ISPSOft, compile the program in the isp file, and save the isp file. After the program in the isp file is compiled, the users can back up the isp file.

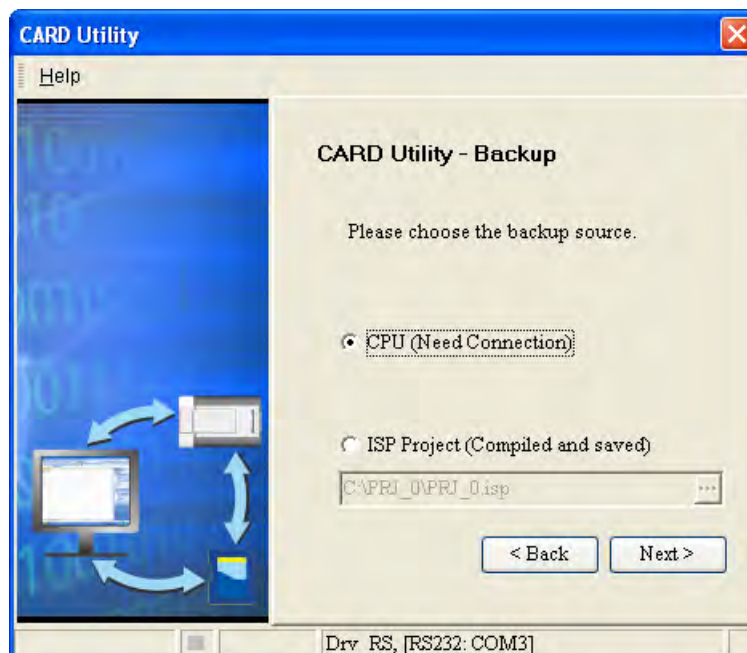

7

- (3) After the users select the **CPU (Need Connection)** option button, they have to decide whether to back up the values in the devices in the AH500 series CPU module which is connected to ISPSOft.

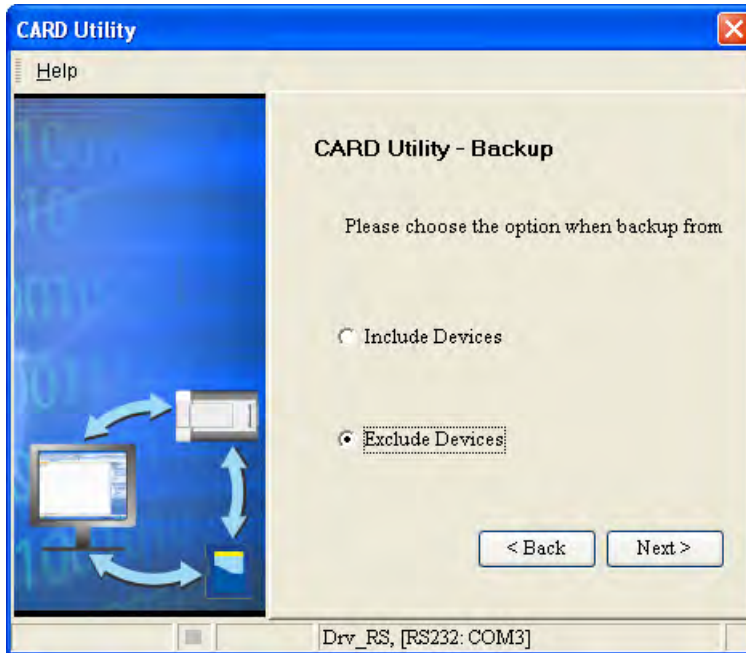

- (4) Select a backup destination. If the backup source is an ISPSOft project, the backup destination must be a computer.
- If the **Memory Card (PLC Side)** option button is selected, the filename of the backup file which will be produced will be **AUTOEXEC.dup**, and the path which points to the backup file will be **Root directory of the memory card\AH500\SysDup\AUTOEXEC.dup**.
 - If the **PC (DUP File)** option button is selected, the users have to click **...**, select a folder in the **Save in** drop-down list box in the **Save As** window, and type a filename in the **File name** box.

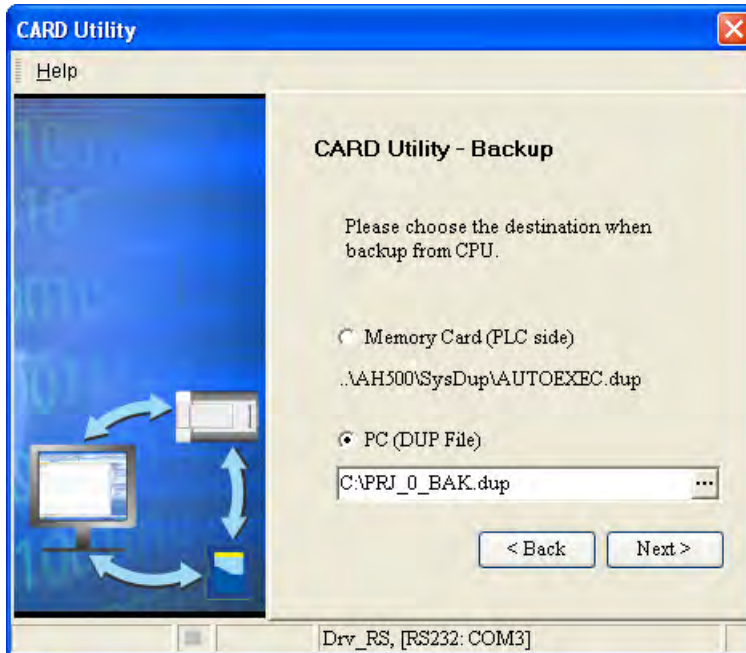

7

- (5) After the users make sure that the summary in the **CARD Utility** window is consistent with the data backup which will be performed, they can click **Execute**.

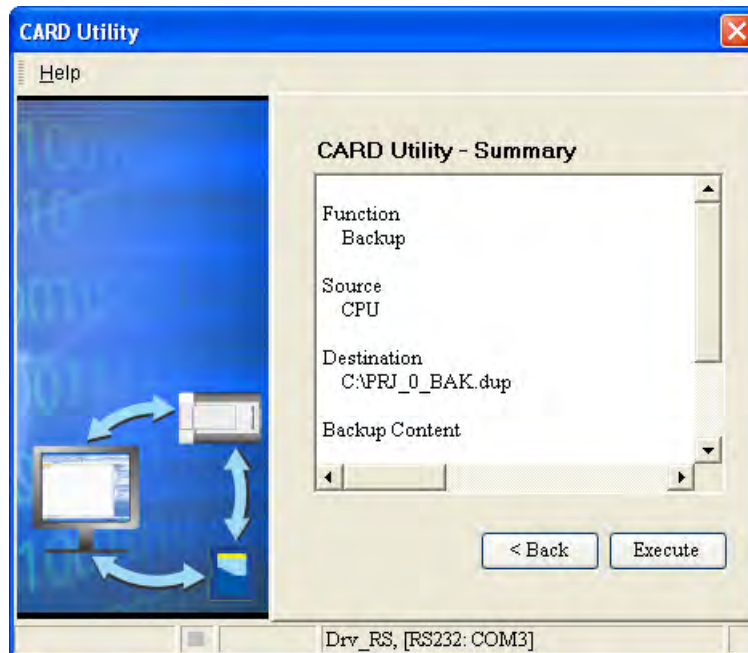

Even if the users click **Cancel** to stop ISPSOft from performing the data backup in the process of backing up data in the AH500 series CPU module onto the memory card inserted in the AH500 series CPU module, the AH500 series CPU module will still perform the data backup. The users can turn off the AH500 series CPU module to stop the data backup from being performed. However, the backup file produced is not a complete backup file. As a result, the users have to delete the backup file from the memory card. If the **Memory Card (PLC Side)** option button is selected, the filename of the backup file which will be produced will be **AUTOEXEC.dup**, and the path which points to the backup file will be **Root directory of the memory card\AH500\SysDup\AUTOEXEC.dup**. If there is an old backup file in the memory card inserted in the AH500 series CPU module which is connected to ISPSOft, the **Warning** window will appear. The users have to click **Replace**, **Archive**, or **Cancel** in the Warning window according to the message in the window.

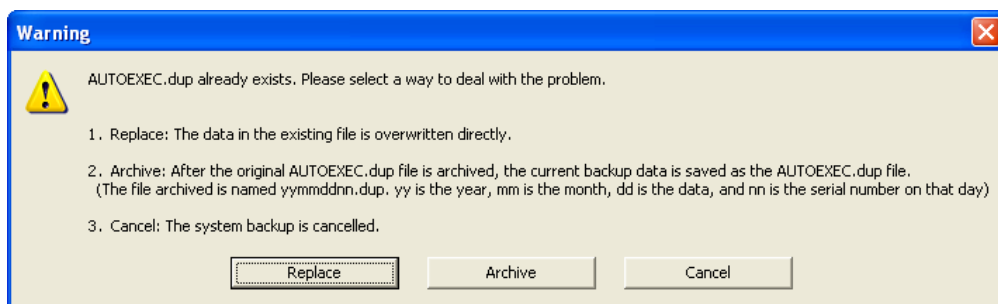

If the data backed up is protected by passwords, these passwords will also be backed up.

Data backup	Description
CPU module→Memory card	The data backed up includes the PLC ID and the PLC password set in the CPU module.
CPU module→Computer	The system asks users to type a PLC ID and a PLC password. If the PLC ID and the PLC password typed are correct, the data backup will be performed. The data backed up includes the PLC ID and the PLC password.
ISPSOft project→Computer	The data backed up includes the program ID and the project password set in the ISPSOft project.

(6) After the data backup is performed, the users can click **Home** or **Close** in the **CARD Utility** window.

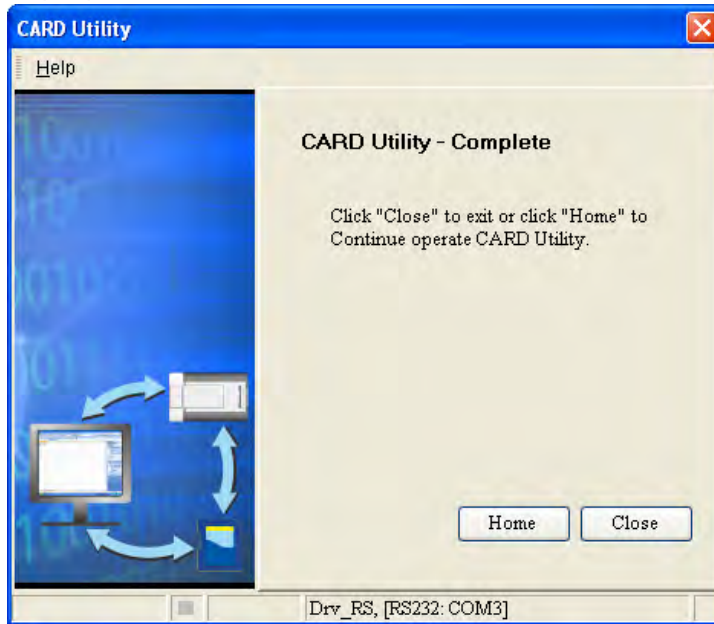

7.8 Restoration

If the restoration source/restoration destination is an AH500 series CPU module or the memory card inserted in an AH500 series CPU module, users have to make sure that ISPSOft is connected to the AH500 series CPU module normally. Please refer to section 2.4 in ISPSOft User Manual for more information.

(1) Select the **Restore (From DUP File)** option button in the **CARD Utility** window, and then click **Next**.

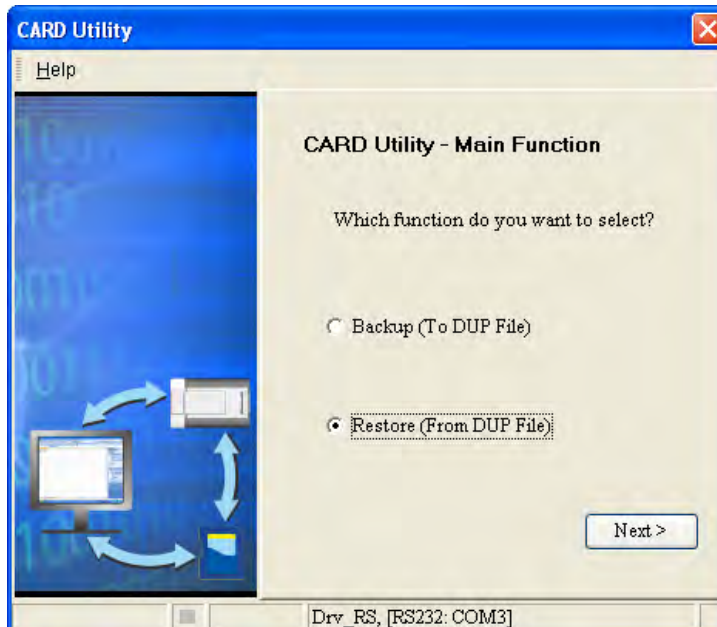

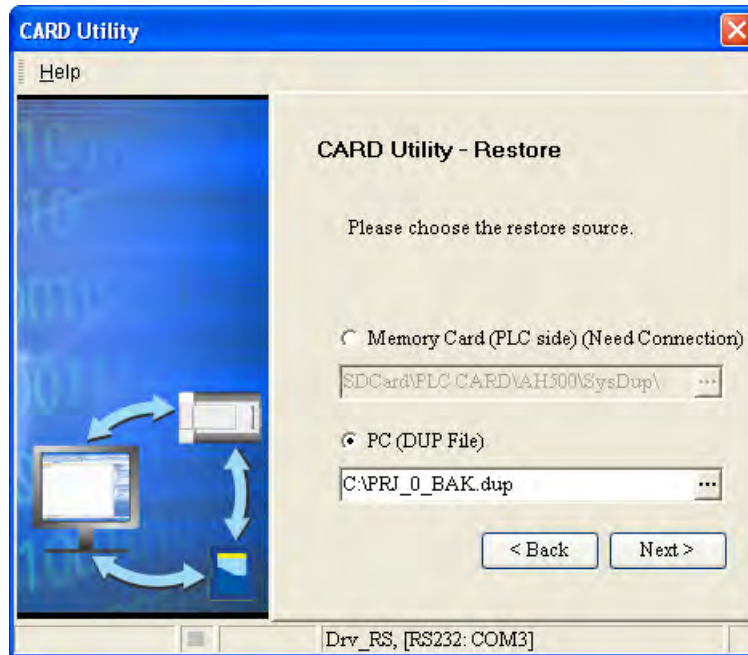

7

- (2) Select a restoration source, click , and select a backup file.

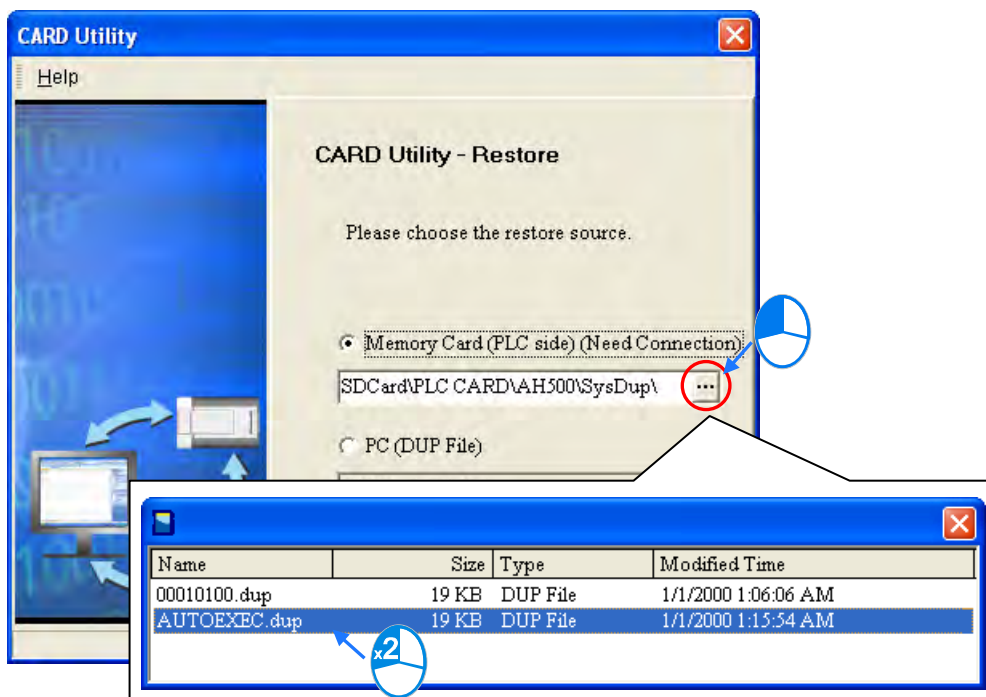

If the **Memory Card (PLC side) (Need Connection)** option button is selected, the backup files in the memory card inserted in the AH500 series connected to ISPSOft will be displayed in a window after  is clicked. The users have to double-click a backup file in the window.



- (3) Select a restoration destination, and then click **Next**.
- If the users want to put the backup file selected into the AH500 series CPU module which is connected to ISPSOft, they have to select the **CPU (Need Connection)** option button. If the restoration source is the memory card inserted in the AH500 series CPU module connected to ISPSOft, the restoration destination must be the AH500 series CPU module.
 - If the **ISP Project** option button is selected, the users have to click . After the users click , they have to specify a filename and a path. If the path specified point to a file which exists in the computer, the file will be overwritten after the data restoration is performed.

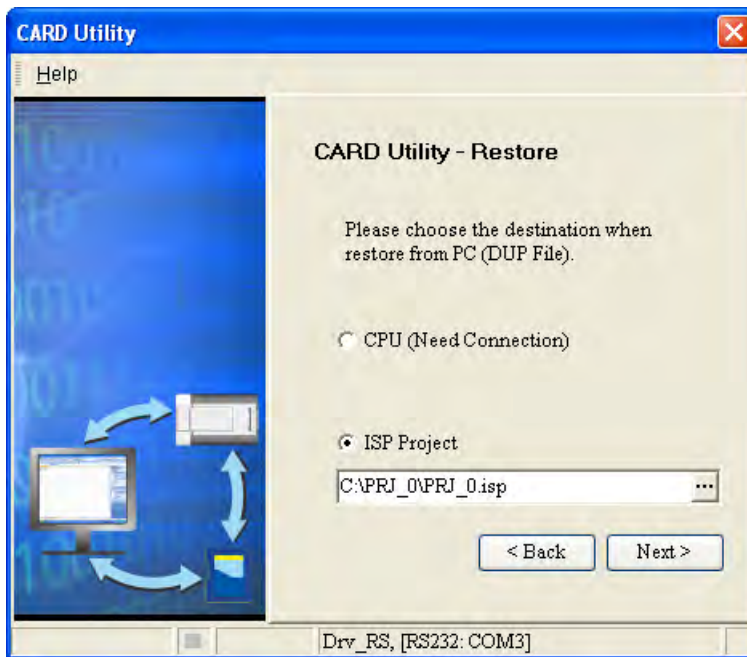

- (4) After the users make sure that the summary in the **CARD Utility** window is consistent with the data restoration which will be performed, they can click **Execute**.

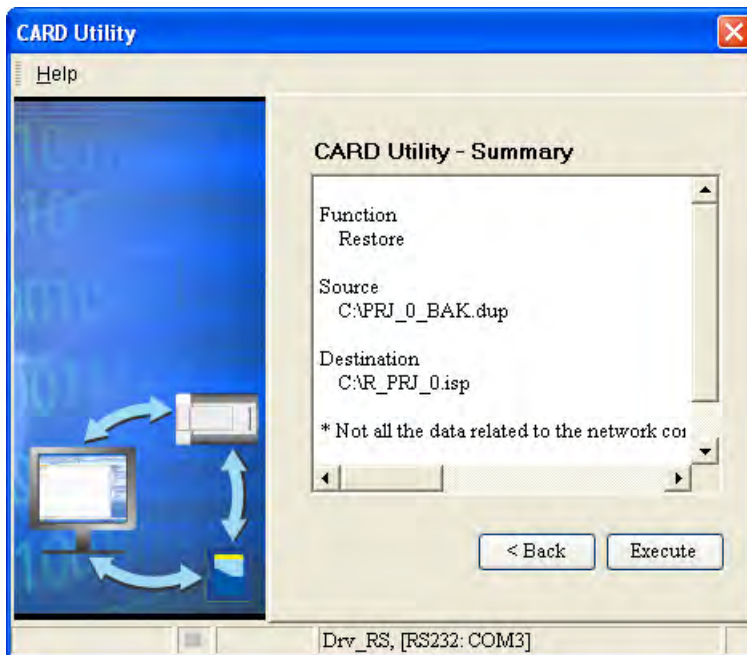

7

If the users click **Cancel** in the process of restoring data to the AH500 series CPU module, the data will not be completely restored. To prevent the AH500 series CPU module from operating incorrectly, the users have to restore the AH500 series CPU module to the factory setting if they do not perform the data restoration again. Besides, the AH500 series CPU module will still performs the data restoration even if the users click **Cancel** in the process of restoring a backup file in the memory card inserted in the AH500 series CPU module. The users can turn off the AH500 series CPU module to stop the data restoration from being performed.

If restoration source/restoration destination contains a password and an ID, the password and the ID will be processed.

Data restoration	Description
------------------	-------------

Memory card→CPU module	<p>a. The ID in the backup file must be the same as the ID in the CPU module, otherwise the data restoration will not be performed.</p> <p>b. If there is a PLC password in the CPU module, the password in the backup file must be the same as the PLC password in the CPU module. Otherwise the data restoration will not be performed.</p> <p>c. If there is no PLC password in the CPU module, and there is a password in the backup file, the system will perform the data restoration, and the password in the backup file will become the PLC password in the CPU.</p>
Computer→CPU module	<p>a. The ID in the backup file must be the same as the ID in the CPU module, otherwise the data restoration will not be performed.</p> <p>b. If there is a PLC password in the CPU module, the password in the backup file must be the same as the PLC password in the CPU module. Otherwise the data restoration will not be performed, and a message will appear.</p> <p>c. If there is no PLC password in the CPU module, and there is a password in the backup file, the system will perform the data restoration, and the password in the backup file will become the PLC password in the CPU.</p>
Computer→ISPSoft project	The ID and the password in the backup file will become the program ID and the project password in an ISPSoft project.

- (5) After the data restoration is performed, the users can click **Home** or **Close** in the **CARD Utility** window.

MEMO

7



Chapter 8 Hardware Configuration

Table of Contents

8.1	Hardware Configuration Tool for AH500 Series Modules—HWCONFIG	8-3
8.1.1	Introduction of the Environment of HWCONFIG	8-3
8.1.2	Configuring a Module	8-5
8.1.2.1	Adding a Module	8-5
8.1.2.2	Assigning Devices to a Module	8-8
8.1.2.3	Editing a Comment	8-12
8.1.2.4	Deleting a Module	8-13
8.1.2.5	Replacing a Module	8-13
8.1.2.6	Searching for/Replacing a Module	8-14
8.1.2.7	Copying/Pasting a Module	8-18
8.1.2.8	Cutting/Pasting a Module	8-20
8.1.2.9	Dragging a Module	8-21
8.1.2.10	Adding an Extension Rack	8-22
8.1.2.11	Deleting a Rack	8-23
8.1.2.12	Replacing a Rack	8-24
8.1.2.13	Cutting/Copying/Pasting an Extension Rack	8-25
8.1.2.14	Dragging an Extension Rack	8-28
8.1.2.15	Rearranging the Input/Output Devices	8-28
8.2	Setting the Parameters in an AH500 Series CPU Module	8-29
8.2.1	Opening the PLC Parameter Setting Window	8-29
8.2.2	Setting the Basic CPU Parameters	8-30
8.2.2.1	CPU: Name	8-30
8.2.2.2	CPU: System	8-31
8.2.2.3	CPU: Latched Device Range	8-34
8.2.3	COM Port	8-36
8.2.4	Ethernet—Basic	8-37
8.2.5	Ethernet—Advance	8-38
8.2.5.1	Ethernet—Advance: Filter	8-38
8.2.5.2	Ethernet—Advance: NTP	8-40
8.2.5.3	Ethernet—Advance: Email	8-41
8.2.5.4	Ethernet—Advance: Email Trigger	8-42
8.2.5.5	Ethernet—Advance: Email and Trigger Configuration	8-45
8.2.5.6	Ethernet—Advance: Socket	8-46
8.2.5.7	Ethernet—Advance: Web	8-48
8.2.6	Saving and Downloading/Uploading the PLC Parameters	8-49
8.3	Setting the Parameters in an AH500 Series Module	8-50
8.3.1	Managing the Version of a Module	8-50
8.3.2	Setting the Parameters in a Module	8-52
8.3.3	Exporting and Importing the Parameters in a Module	8-56
8.3.4	Setting the Parameters in an Intelligent Module	8-57
8.4	Management of the Parameters in AH500 Series Hardware and Online Diagnosis	8-58
8.4.1	Saving and Printing a Hardware Configuration	8-58
8.4.2	Purchase Order	8-59
8.4.3	Rack Information List	8-60
8.4.4	Downloading/Uploading the System Parameters	8-61
8.4.5	I/O Scan	8-62
8.4.6	Online Diagnosis	8-63
8.4.6.1	Online Mode	8-64

8.4.6.2	Module Information and Diagnosis	8-65
8.4.6.3	Changing the Status of a Module Online	8-66
8.4.6.4	Monitoring Table.....	8-68
8.5	Setting Interrupts	8-69
8.5.1	Program Architectures	8-69
8.5.2	Tasks Supported by AH500 Series CPU Modules	8-69
8.5.3	I/O Interrupts.....	8-70
8.5.4	Low Voltage Detection Interrupt.....	8-71
8.5.5	Communication Interrupts.....	8-71
8.5.6	External Interrupts	8-72
8.5.7	Timer Interrupts	8-73

8.1 Hardware Configuration Tool for AH500 Series Modules—HWCONFIG

HWCONFIG is a built-in hardware configuration tool in ISPSOft. Users can configure racks, set CPU parameters, set module parameters, download/upload parameters, detect a hardware configuration online, and make a diagnosis through HWCONFIG.

All parameters set in HWCONFIG must be downloaded to the CPU module so that they can take effect. (Please refer to section 8.4.4 for more information.)

8.1.1 Introduction of the Environment of HWCONFIG

After users double-click **HWCONFIG** in the project management area, the **HWCONFIG** window will appear.

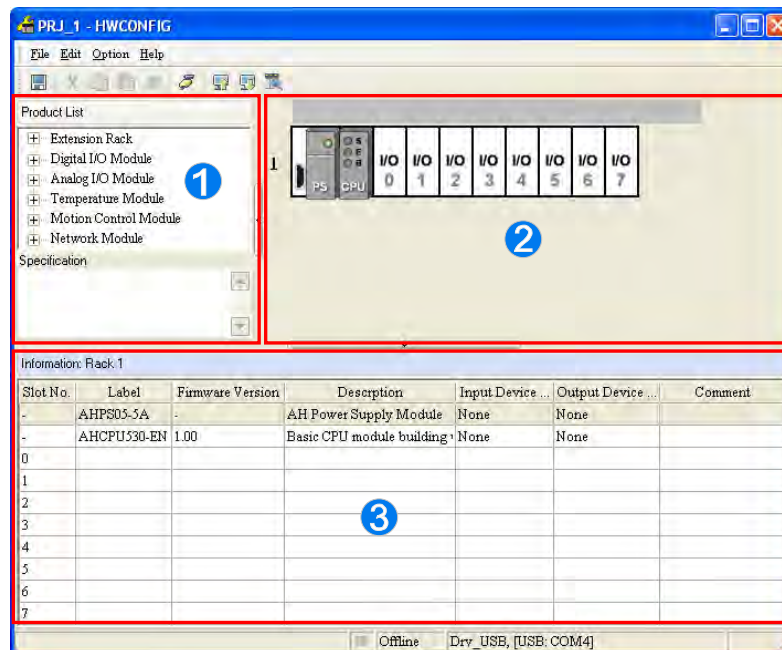
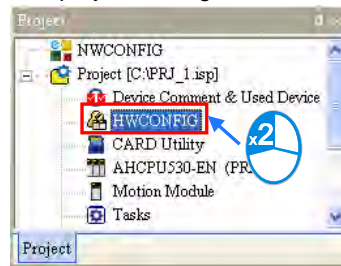

- 1 Product list:** Hardware available is listed in the catalogue.
- 2 System configuration area:** It is the main working area. Users can configure and set a whole system in this area.
- 3 Information list:** The information about the present system configuration is listed in the list.

The present system configuration is displayed in the system configuration area. The number at the left side of a rack is a rack number, and the number on a slot is a slot number. Users can select a module by clicking the module.



If users want to select a rack, they can move a mouse cursor to the extension port on the rack, and click the extension port.

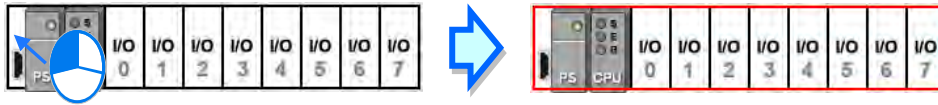

When a rack is selected, the information about the present configuration for the rack is listed in the information list. If a module is selected, the information about the module on the list will be selected. If the information about a module is selected, the module in the system configuration area will be selected. Besides, if the configuration in the system configuration area is modified, the information on the information list will be updated.

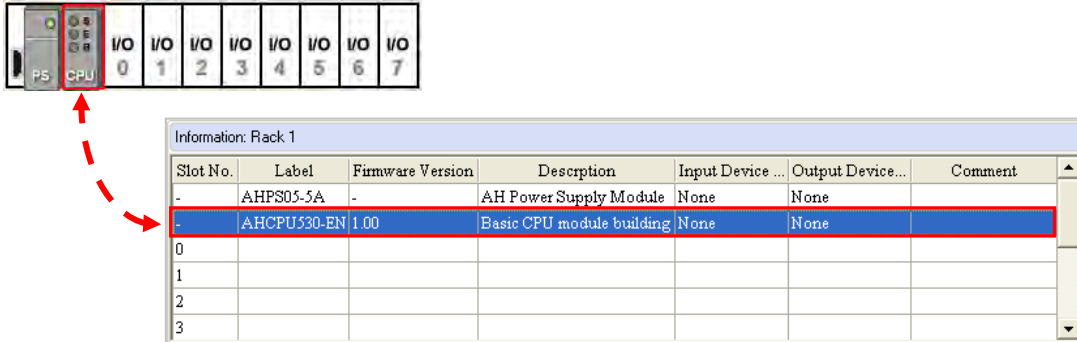

All hardware available is listed in the product list. After a section is unfolded, all devices belongs to the section are listed under the section. If users click a device, the specifications for the device will be under the product list.

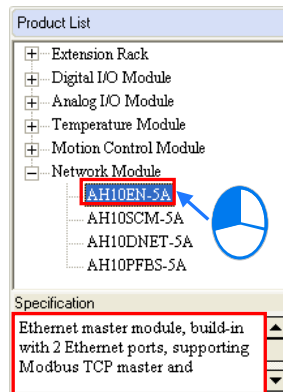

8.1.2 Configuring a Module

8.1.2.1 Adding a Module

- **Method 1**

After users select a module which will be added to the product list, they can drag it to a vacant slot.

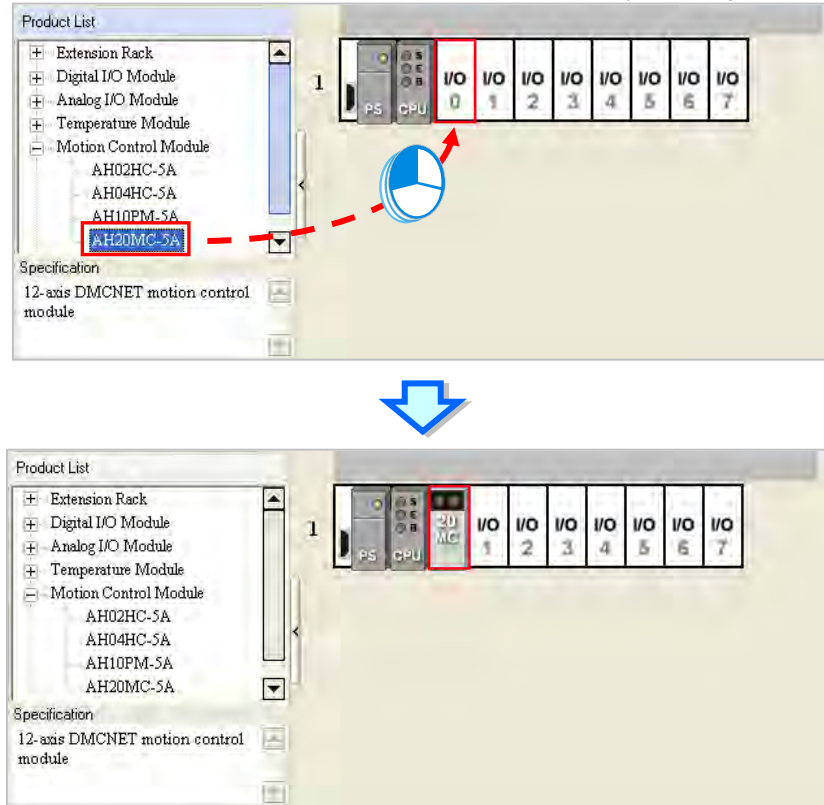

*. If users want to drag a module on the product list to the system configuration area, the module can only be put on a vacant slot. If the module is dragged to an occupied slot, the system will prohibit this operation.

- **Method 2**

(1) After users click a vacant slot, the **Module Selection** window will appear. The users can also right-click a vacant slot, and click **Add** on the context menu to open the **Module Selection** window.

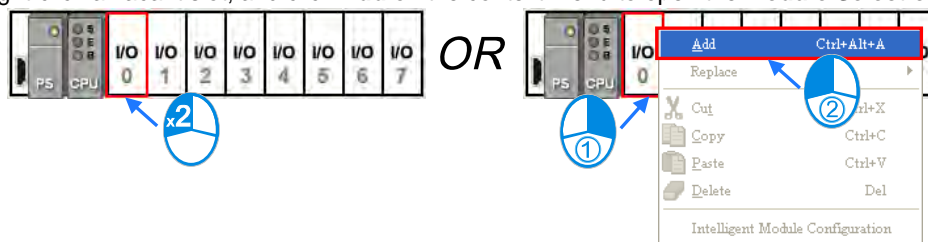

- (2) If the users click a module in the **Module Selection** window, the specifications for the module will appear in the **Specification** box. After the users double-click a module in the **Module Selection** window, the module will be added.

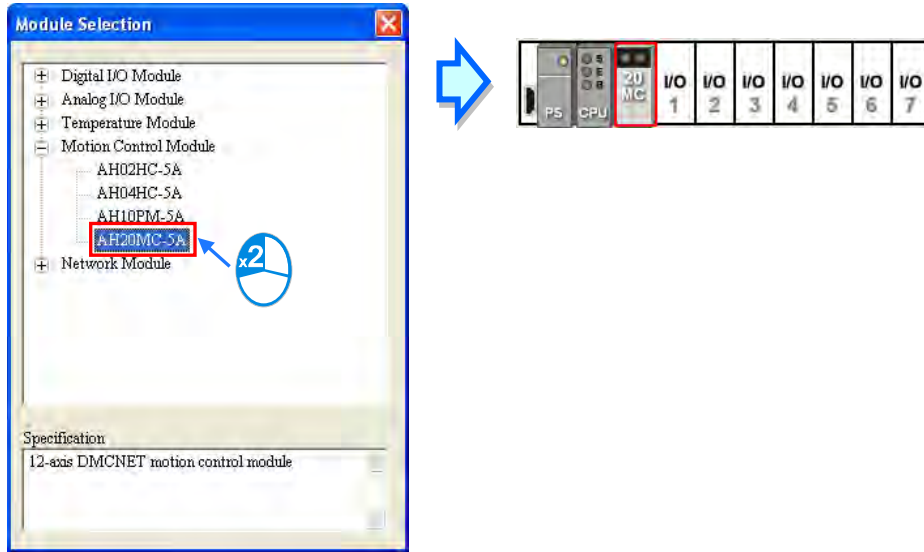

● **Method 3**

- (1) After users click a blank on the information list, the **Module Selection** window will appear. The users can also double-click a blank on the information list, and click **Add** on the context menu to open the **Module Selection** window.

Information: Rack 1

Slot No.	Label	Firmware ...	Description	Input Device ...	Output Device ...	Comment
-	AHPS05-5A	-	AH Power Supply Module	None	None	
-	AHCPU530-EN	1.00	Basic CPU module building	None	None	
0						
1						
2						
3						
4						
5						
6						
7						

OR

Information: Rack 1

Slot No.	Label	Firmware ...	Description	Input Device ...	Output Device ...	Comment
-	AHPS05-5A	-	AH Power Supply Module	None	None	
-	AHCPU530-EN	1.00	Basic CPU module building	None	None	
0						
1						
2						
3						
4						
5						
6						
7						

Add Ctrl+Alt+A

Replace

Cut Ctrl+C

Copy Ctrl+V

Paste Del

Delete

Intelligent Module Configuration

- (2) If the users click a module in the **Module Selection** window, the specifications for the module will appear in the **Specification** box. After the users double-click a module in the **Module Selection** window, the module will be added.

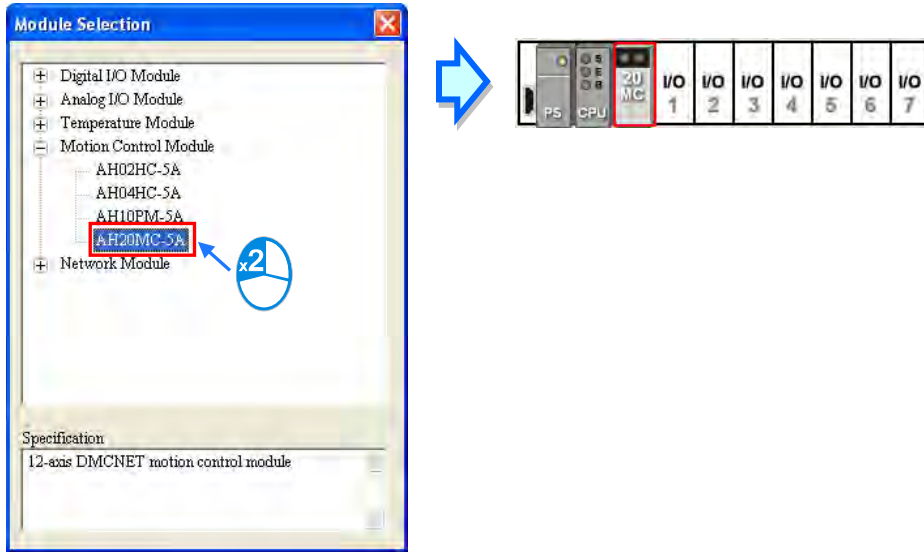

No matter which method is used to add a module, the configuration in the system configuration area and the information on the information list will be updated after a module is added.

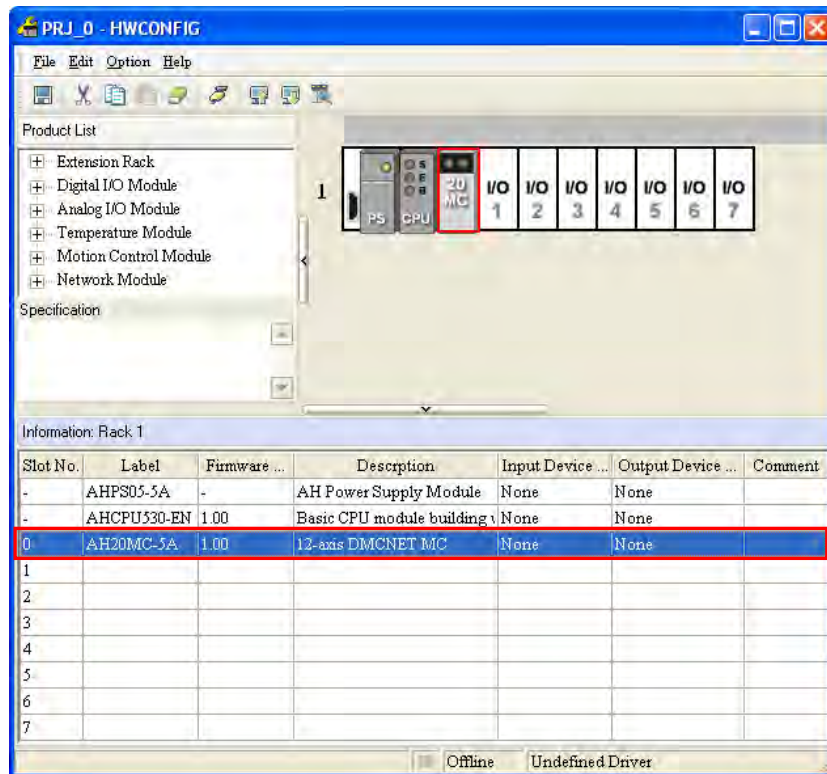

8.1.2.2 Assigning Devices to a Module

The data in a module needs to be updated constantly. For example, analog signals received by an analog input module are updated constantly, and converted to data which can be processed by a CPU module. As a result, the system automatically assigns devices to a module so that the data in the module can be stored. The devices assigned to a module are displayed in the **Input Device Range** cell and the **Output Device Range** cell on the information list. Please refer to the following example.

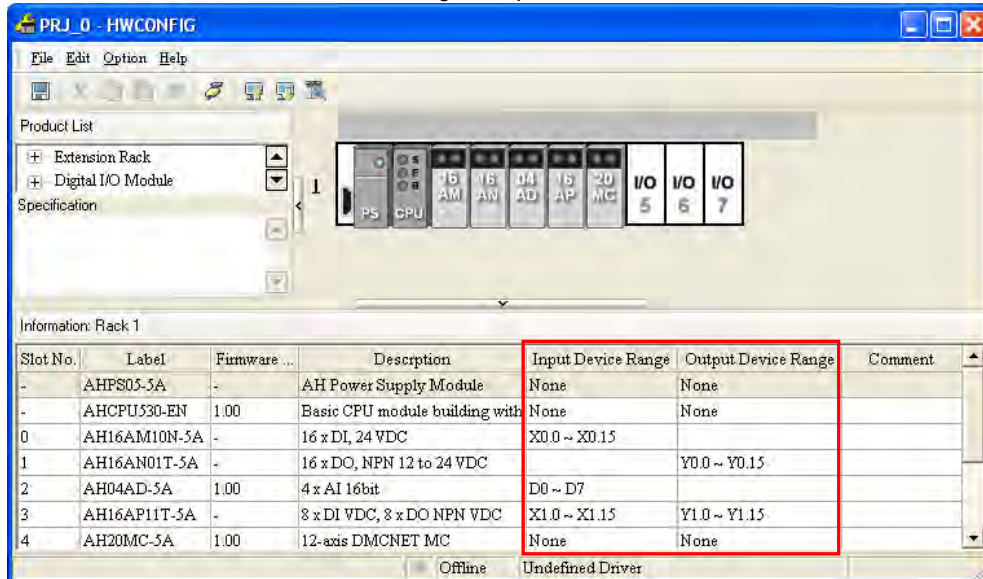

- **AH16AM10N-5A (slot 0)**
AH16AM10N-5A is a digital input module which has 16 inputs. The system assigns X0.0~X0.15 to AH16AM10N-5A so that data received by AH16AM10N-5A can be stored.
- **AH16AN01T-5A (slot 1)**
AH16AN01T-5A is a digital output module which has 16 outputs. The system assigns Y0.0~Y0.15 to AH16AN01T-5A so that data sent by AH16AM10N-5A can be stored.
- **AH04AD-5A (slot 2)**
AH04AD-5A is an analog input module which has four channels. The system assigns D0~D7 to AH04AD-5A. After analog signals received by AH04AD-5A are converted into digital data, the digital data will be stored in D0~D7.
- **AH16AP11T-5A (slot 3)**
AH16AP11T-5A is a digital input/output module which has 8 inputs and 8 outputs. The system assign X1.0~X1.15 to AH16AP11T-5A so that data received by AH16AP11T-5A can be stored. (X1.0~X1.7 are actually used.) The system also assigns Y1.0~Y1.15 to AH16AP11T-5A so that data sent by AH16AP11T-5A can be stored. (Y1.0~Y1.7 are actually used.)
- **AH20MC-5A (slot 4)**
AH20MC-5A is a motion control module. Owing to the fact that the data in AH20MC-5A does not need to be updated constantly, the system does not assign any device to AH20MC-5A.



If users want to know functions to which devices assigned correspond, they can double-click the module or the information about the module on the information list to open the **Parameter Setting** window.

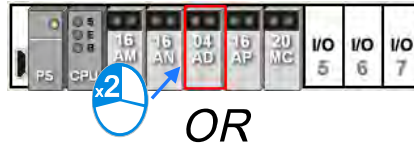

Slot No.	Label	Firmware ...	Description	Input Device Range	Output Device Range	Comment
-	AHPS05-5A	-	AH Power Supply Module	None	None	
-	AHCPU30-EN	1.00	Basic CPU module building with	None	None	
0	AH16AM10N-5A	-	16 x DI, 24 VDC	X0.0 ~ X0.15		
1	AH16AN01T-5A	-	16 x DO, NPN 12 to 24 VDC		Y0.0 ~ Y0.15	
2	AH04AD-5A	1.00	4 x AI 16bit	D0 ~ D7		
3	AH16AP11T-5A	-	8 x DI VDC, 8 x DO NPN VDC	X1.0 ~ X1.15	Y1.0 ~ Y1.15	
4	AH20MC-5A	-	12-axis DMCNET MC	None	None	
5						
6						
7						

*. To avoid the cells which can be edited, if users want to double-click the information about a module on the information list, they can double-click Slot No. cell, the Label cell, or the Description cell.

After users click the **Normal Exchange Area** tab in the **Parameter Setting** window, they can see functions to which devices correspond.

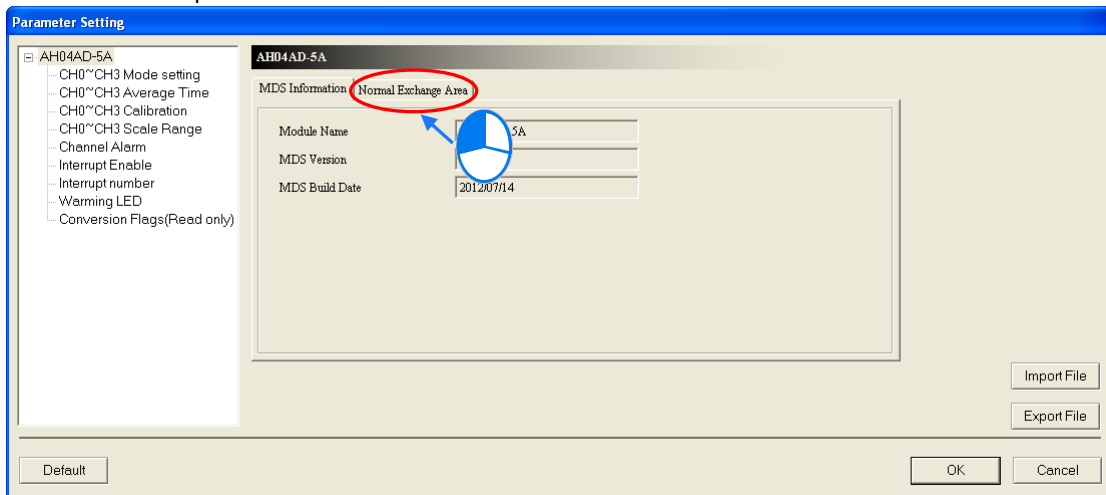

MDS Information		Normal Exchange Area	
	Description		Address
▶	CH0 Input value		D0 - D1
	CH1 Input value		D2 - D3
	CH2 Input value		D4 - D5
	CH3 Input value		D6 - D7

The system automatically assigns devices to a module so that the data in the module which needs to be updated constantly can be stored. The parameters in a module do not need to be updated constantly. Users assign data registers to a module so that the parameters in the module can be stored. When the system operates, the data registers in a CPU module are synchronized to the parameters in the module. As a result,

the users can access the module through the data registers. Accessing a module through the data registers is more efficient than accessing the module through the instruction FROM/TO.

As the example below shows, D3000 corresponds to the parameter **CH0 Average Time** in the **Parameter Setting** window for AH04AD-5A. After the parameters in HWCONFIG are downloaded to the CPU module, users can change the value of the parameter **CH0 Average Time** by changing the value in D3000 in the CPU module.

Besides, if users write a value which is not allowed by a parameter into a data register during the operation of the system, the system will restore the value in the data register and the value of the parameter to the original values.

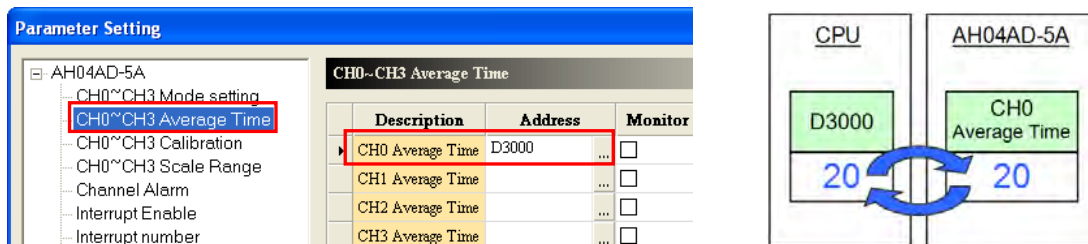

*. Please refer to section 8.3 for more information about the setting of parameters in a module. Please refer to programming manuals for more information about the instruction FROM/TO.

The **Input/Output Device Range** column on the information list can be defined not only by the system, but also by users. Users can click a cell on the information list, and then click **...**, or type a start address directly. After the **Manual Assignment** window appears, the users can type a start address, and click **OK**.

Slot No.	Label	Firmware ...	Description	Device Range	Output Device Range	Comment
-	AHPS05-5A	-	AH Power Supply Module		None	
-	AHCPU530-EN	1.00	Basic CPU module building with		None	
0	AH16AM10N-5A	-	16 x DI, 24 VDC	X0.0 ~ X0.15		
1	AH16AN01T-5A	-	16 x DO, NPN 12 to 24 VDC		Y0.0 ~ Y0.15	

The 'Manual Assignment' dialog box has an 'Input Device Range' section. It contains three fields: 'Device' with a dropdown menu showing 'X', 'Number' with a text input field containing '10', and 'Length' with a dropdown menu showing '1'. There are 'OK' and 'Cancel' buttons at the bottom right.

Slot No.	Label	Firmware ...	Description	Input Device Range	Output Device Range	Comment
-	AHPS05-5A	-	AH Power Supply Module	None	None	
-	AHCPU530-EN	1.00	Basic CPU module building with	None	None	
0	AH16AM10N-5A	-	16 x DI, 24 VDC	X10.0 ~ X10.15		
1	AH16AN01T-5A	-	16 x DO, NPN 12 to 24 VDC		Y0.0 ~ Y0.15	

8

Devices that users assign to a module so that the data in the module can be stored can not overlap data registers that the users assign to a module so that the parameters in the module can be stored. If a device address typed conflicts with another device address, the system will modify the device address which is typed, and provide a device address which can be used. For example, if users want to assign D3000 which has been assigned to a module to another module, the system will provide a device address which can be used.

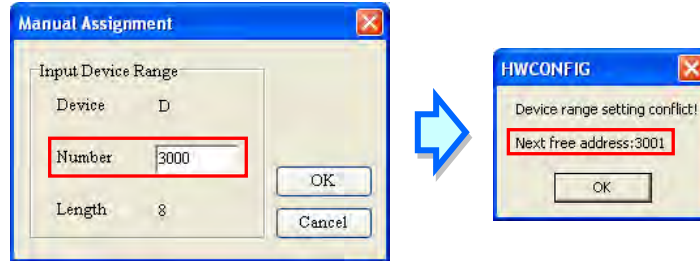

After the input/output device addresses assigned to a module are changed, the input/output device addresses assigned to a module added will follow the new input/output device addresses assigned to the preceding module, and the input/output device addresses which have been assigned will be skipped. Even if the new input/output device addresses assigned to the preceding module are not the largest addresses, the input/output device addresses assigned to the module added will follow the new input/output devices addresses.

Please refer to the following example. The input device addresses assigned to AH04AD-5A installed in slot 2 is changed to D50~D57.

Slot No.	Label	Firmware ...	Description	Input Device Range	Output Device Range	Comment
-	AHPS05-5A	-	AH Power Supply Module	None	None	
-	AHCPU530-EN	1.00	Basic CPU module building with	None	None	
0	AH04AD-5A	1.00	4 x AI 16bit	D0 ~ D7		
1	AH04AD-5A	1.00	4 x AI 16bit	D100 ~ D107		
2	AH04AD-5A	1.00	4 x AI 16bit	D200 ~ D207		
3						

Slot No.	Label	Firmware ...	Description	Input Device Range	Output Device Range	Comment
-	AHPS05-5A	-	AH Power Supply Module	None	None	
-	AHCPU530-EN	1.00	Basic CPU module building with	None	None	
0	AH04AD-5A	1.00	4 x AI 16bit	D0 ~ D7		
1	AH04AD-5A	1.00	4 x AI 16bit	D100 ~ D107		
2	AH04AD-5A	1.00	4 x AI 16bit	D50 ~ D57		
3						

The image shows two screenshots of a 'Manual Assignment' dialog box overlaid on a table. The first screenshot shows the dialog box with 'Number' set to 50, and the table row for slot 2 with 'Input Device Range' set to 'D200 ~ D207'. The second screenshot shows the dialog box with 'Number' set to 50, and the table row for slot 2 with 'Input Device Range' set to 'D50 ~ D57'. A blue arrow points from the first screenshot to the second.

The input device addresses assigned to a module added follow D50~D57 rather than D100~D107. As a result, D58~D65 are assigned to AH04AD-5A which is installed in slot 3.

Slot No.	Label	Firmware ...	Description	Input Device Range	Output Device Range	Comment
-	AHPS05-5A	-	AH Power Supply Module	None	None	
-	AHCPU530-EN	1.00	Basic CPU module building with	None	None	
0	AH04AD-5A	1.00	4 x AI 16bit	D0 ~ D7		
1	AH04AD-5A	1.00	4 x AI 16bit	D100 ~ D107		
2	AH04AD-5A	1.00	4 x AI 16bit	D50 ~ D57		
3	AH04AD-5A	1.00	4 x AI 16bit	D58 ~ D65		
4						

8.1.2.3 Editing a Comment

After users click the gray area at the top of the system configuration area, they can type a comment about the hardware configuration in the drop-down box that appears. If users want to start a new line of text at a specific point, they can press Shift+Enter on the keyboard. After the comment is typed, users can press Enter on the keyboard.

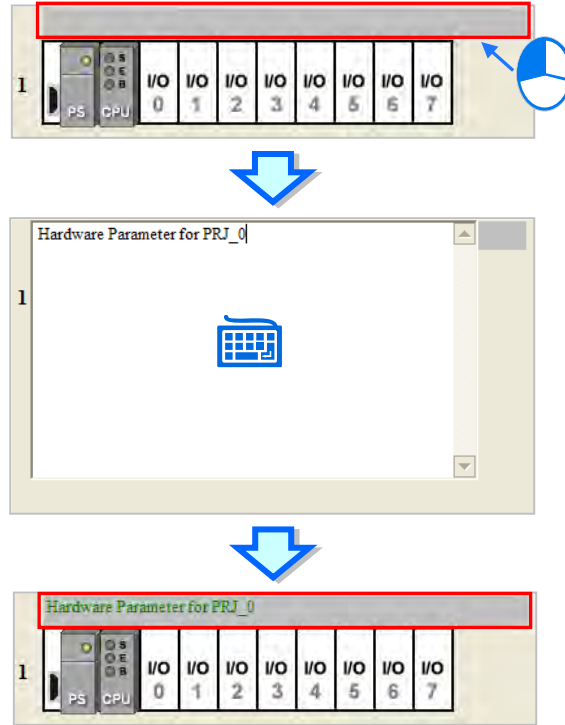

After users click the **Comment** cell for a module on the information list, they can press a key on the keyboard, or click **...** to open the **Comment** window. The users can type a comment about the module in the **Comment** window.

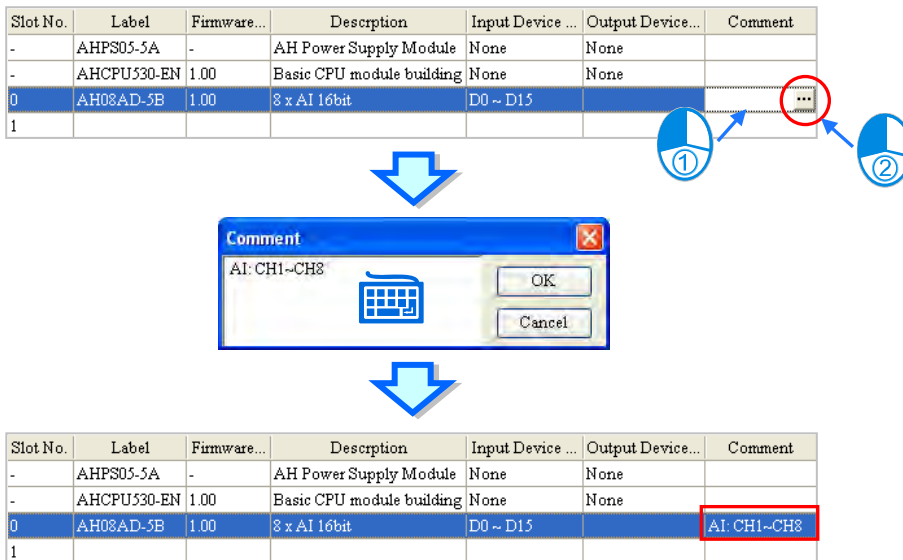

8

8.1.2.4 Deleting a Module

There are two ways to delete a module which has been configured. (The CPU module and the power supply module can not be deleted.)

● **Method 1**

- (1) Select a module which will be deleted from the system configuration area or information list.

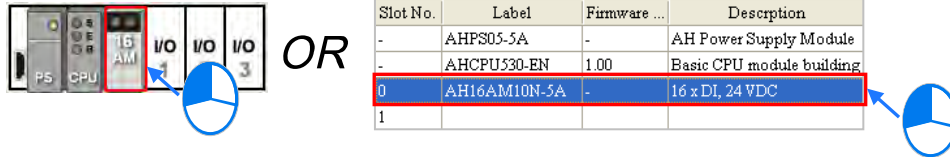

- (2) Click **Delete** on the **Edit** menu, click on the toolbar, or press Delete on the keyboard.

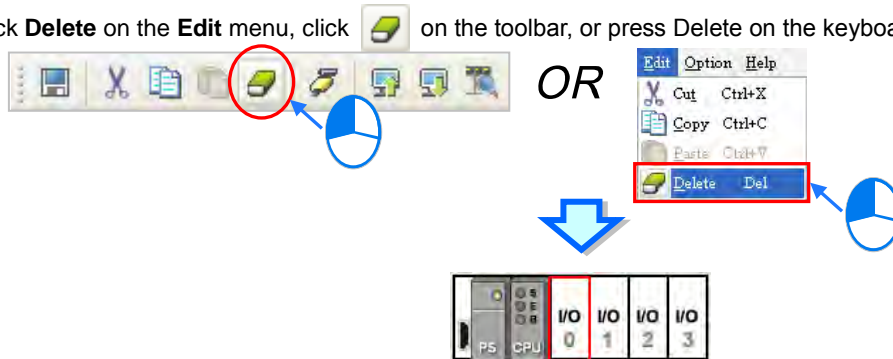

● **Method 2**

- (1) Right-click a module which will be deleted from the system configuration area or information list.

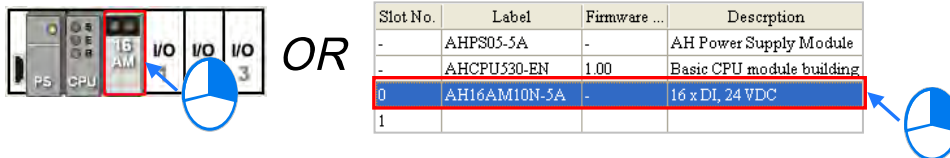

- (2) Click **Delete** on the context menu.

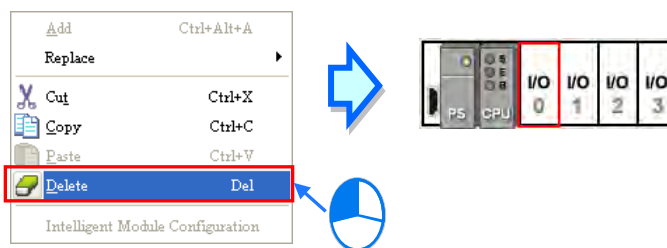

8.1.2.5 Replacing a Module

- (1) Right-click a module which will be replaced in the system configuration area or on the information list. (The CPU module and the power supply module can not be replaced.)

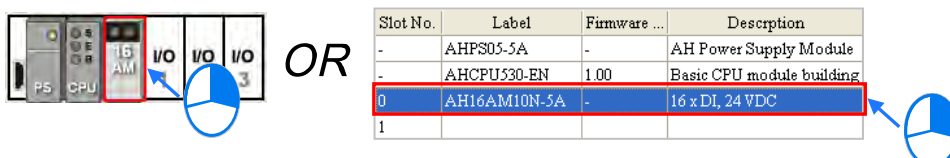

- (2) Point to **Replace** on the context menu, and then click **Sam Type** or **All**.

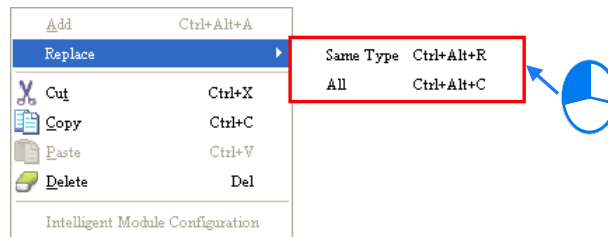

➤ **Same Type**

A module selected is replaced by a same type of module. After the module is replaced, the input/output devices assigned to the new module are the same as the input/output devices assigned to the module replaced. Besides, if the parameters in the new module are not the same as the parameters in the module replaced, the setting of the parameters in the new module will be restored to the default values.

➤ **All**

A module selected can be replaced by any type of module. After the module is replaced, the different input/output devices will be assigned to the new module, and the setting of the parameters in the new module will be restored to the default values.

- (3) After users click **Same Type** or **All**, the **Module Selection** window will appear. Items which can be selected will be displayed in the window. After the users decide on a module, they can double-click the module in the window.

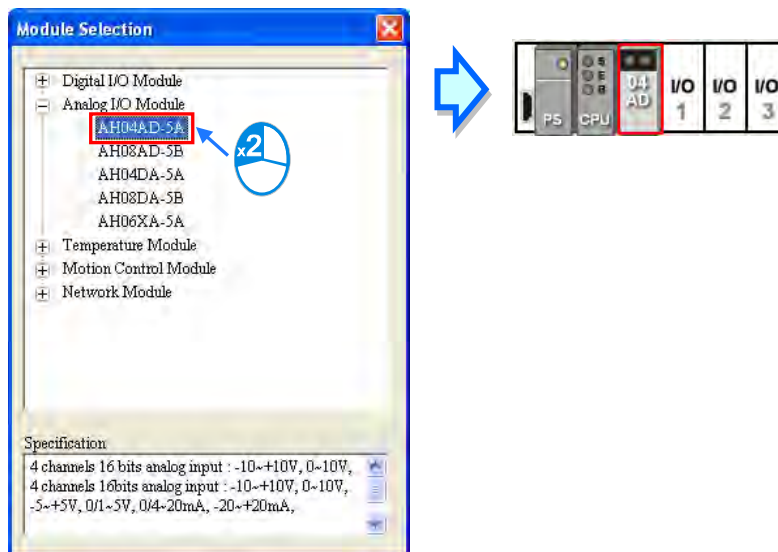

8

8.1.2.6 Searching for/Replacing a Module

- (1) After users click **Search** on the **Option** menu, the **Find and Replace** window will appear.

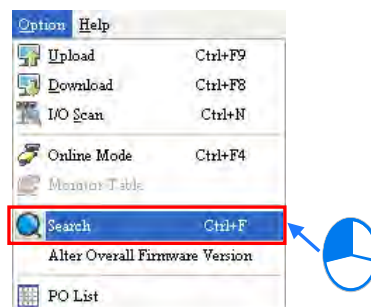

- (2) Click **...** in the **Find what** box, select a module in the **Module Selection** window, and double-click the module. The users can also type part of a module model in the **Find what** box. Finally, click **Find**.

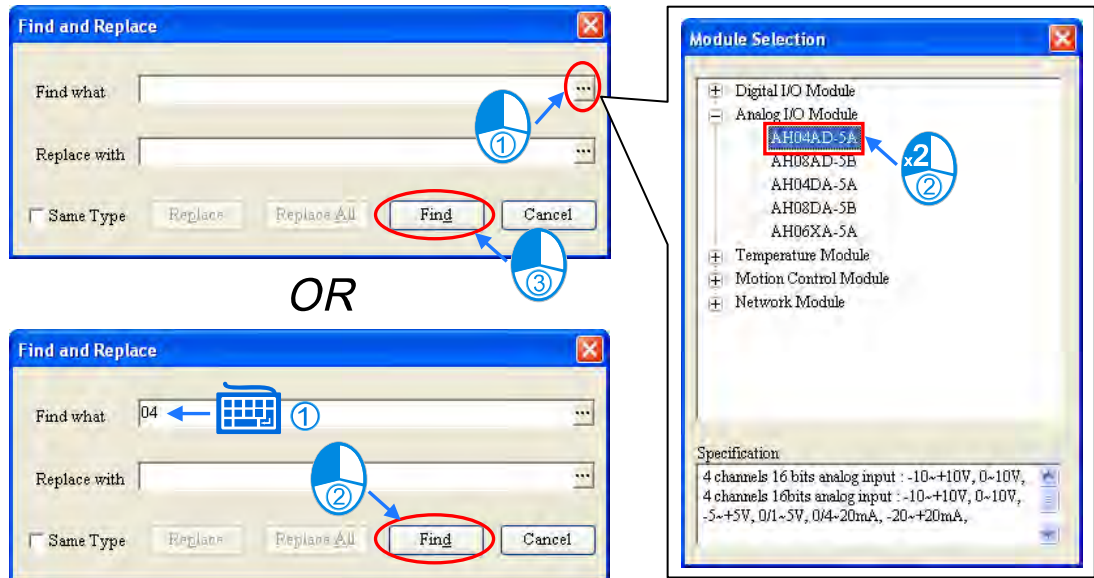

- (3) After the search is complete, modules meet the search condition will be listed in the list. After the users double-click an item on the list, the module corresponding to the item in the system configuration area will be selected.

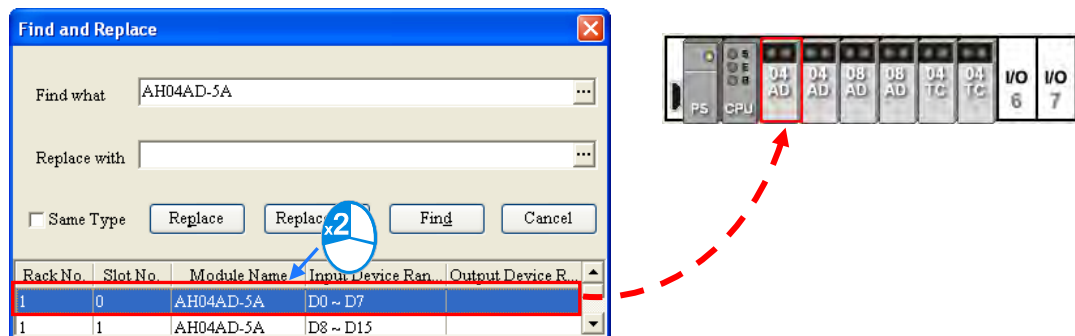

- (4) If the users want to replace a module, they can click a module which will be replaced on the search list. If the users want to replace the module with a same type of module, they can select the **Same Type** checkbox.

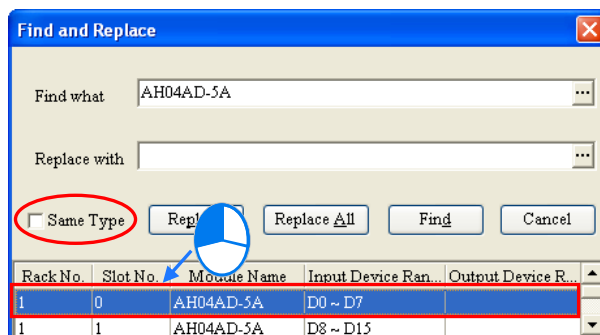

- The **Same Type** checkbox is selected. A module selected is replaced by a same type of module. After the module is replaced, the input/output devices assigned to the new module are the same as the input/output devices assigned to the module replaced. Besides, if the parameters in the new module are not the same as the

parameters in the module replaced, the setting of the parameters in the new module will be restored to the default values.

- The **Same Type** checkbox is not selected.

A module selected can be replaced by any type of module. After the module is replaced, the different input/output devices will be assigned to the new module, and the setting of the parameters in the new module will be restored to the default values.

- (5) Click **...** in the **Replace with** box, select a module in the **Module Selection** window, and double-click the module. Owing to the fact that a module must be replaced by a specific module, typing a module model or part of a module model in the **Replace with** box is not allowed.

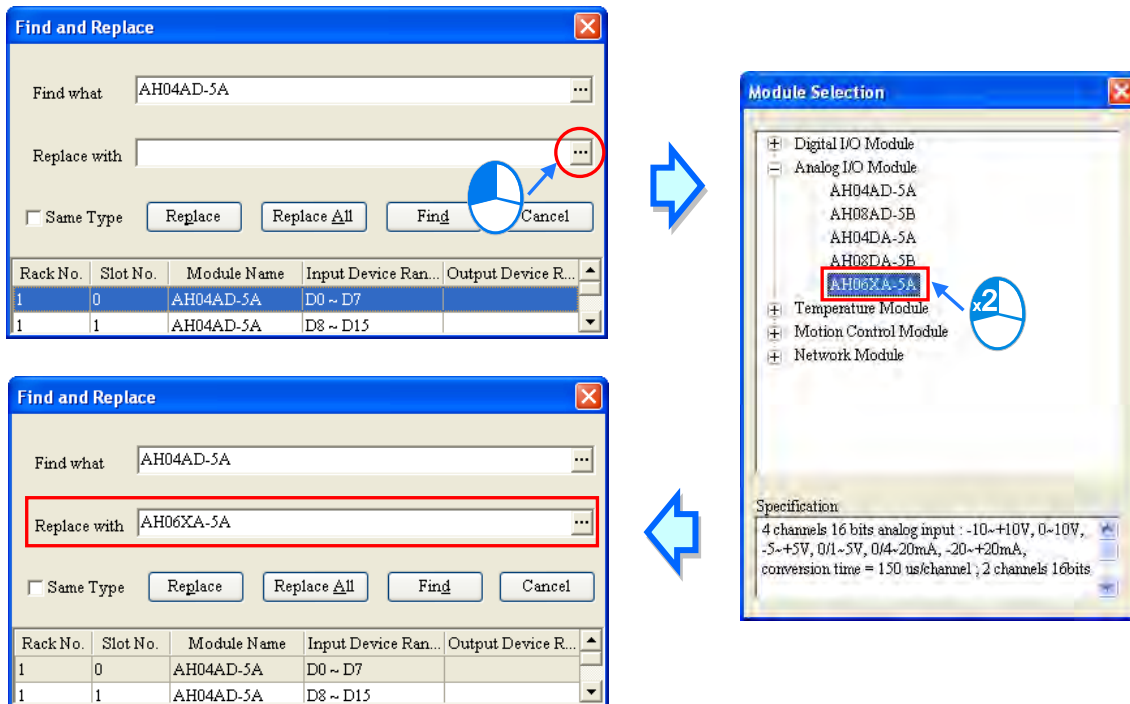

*. If the Replace with box is blank, a module selected will be deleted after Replace is clicked.

- (6) After the setting of the replacement condition is complete, the users can click **Replace** to replace the module selected with the new module. After the replacement is complete, the search list will be updated, and the next module will be selected automatically.

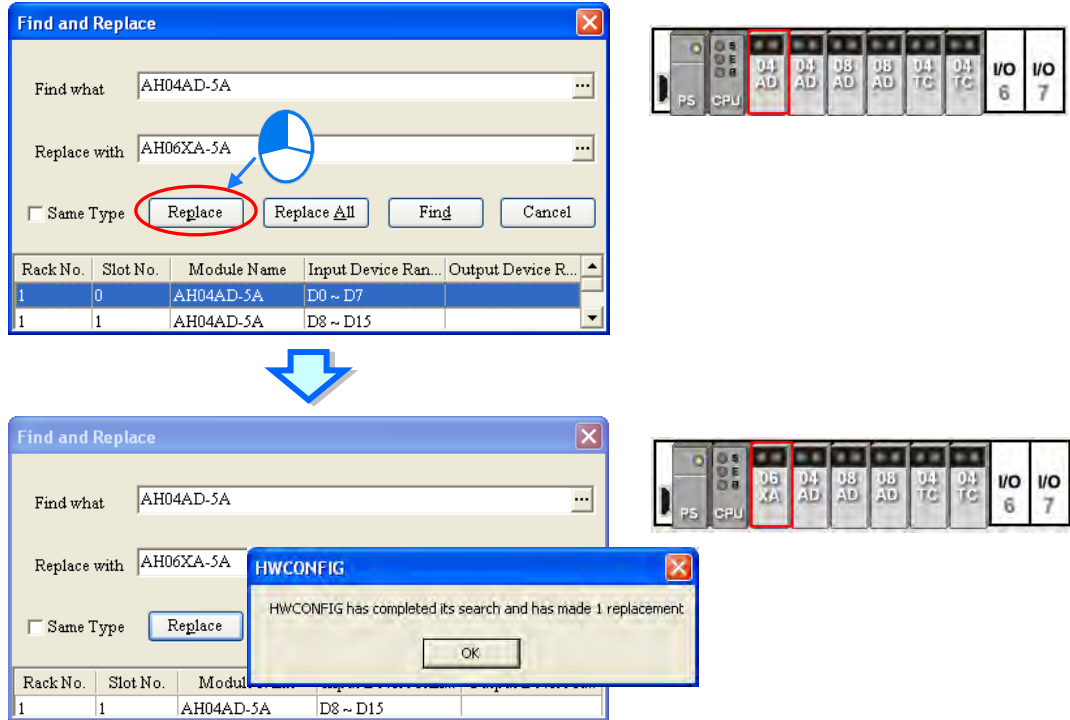

- (7) If the users want to replace all the modules on the list, they can click **Replace All** after the setting of the replacement condition is complete. All the modules on the list will be replaced by the new module.

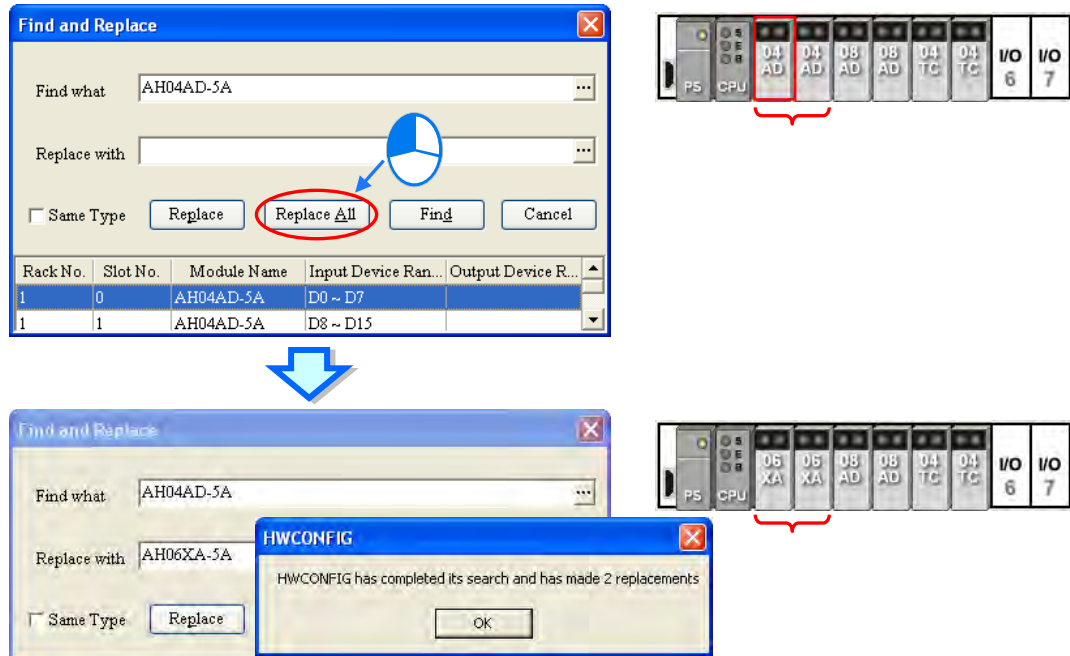

8.1.2.7 Copying/Pasting a Module

There are two ways to copy a module. (The CPU module and the power supply module can not be copied/pasted.)

- **Method 1**

Right-click a module which will be copied in the system configuration area or on the information list, and then click **Copy** on the context menu.

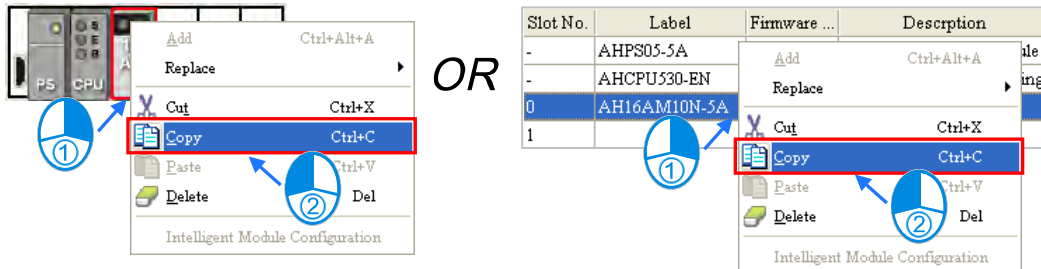

- **Method 2**

(1) Click a module which will be copied in the system configuration area or on the information list.

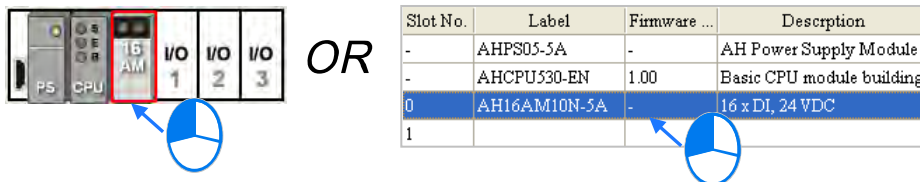

(2) Click **Copy** on the **Edit** menu, or  on the toolbar.

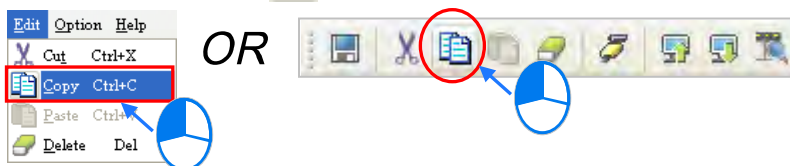

There are two ways to paste a module.

- **Method 1**

Right-click a slot on which a module will be pasted in the system configuration area or on the information list, and then click **Paste** on the context menu.

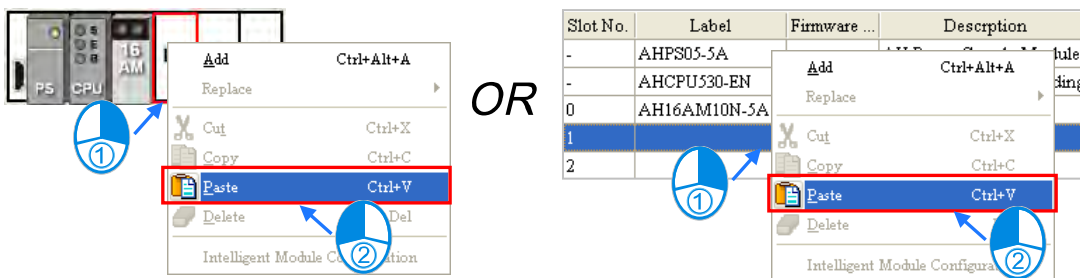

● **Method 2**

(1) Click a slot on which a module will be pasted in the system configuration area or on the information list.

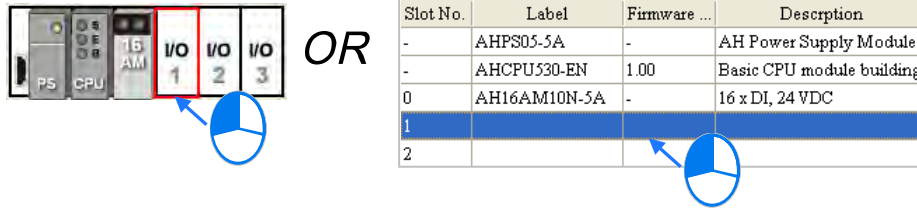

(2) Click **Paste** on the **Edit** menu, or  on the toolbar.



Additional remark

When a module is copied/pasted, the parameters in the module are processed as follows.

- **Input/Output device range:** The input/output devices assigned to the module cut are automatically assigned to the module pasted.
- **Comment about the module:** The comment about the module copied is copied into the module pasted.
- **Parameters in the module:** The parameters in the module cut are copied into the module pasted.
- **Data registers:** The data registers assigned to the module copied are automatically assigned to the module pasted.
- **Parameters in the intelligent module:** The setting of the parameters in the intelligent module is not copied, and is restored to the default values. The users have to set the parameters again.

As the example below illustrates, the module on slot 0 is the module which is copied, and the module on slot 1 is the module which is pasted.

Description	Address	Monitor	Initial
CH0 Average Time	D3000	<input checked="" type="checkbox"/>	30
CH1 Average Time		<input type="checkbox"/>	10

Description	Address	Monitor	Initial
CH0 Average Time	D3001	<input checked="" type="checkbox"/>	30
CH1 Average Time		<input type="checkbox"/>	10

Slot No.	Label	Firmware ...	Description	Input Device ...	Output Device ...	Comment
-	AHPS05-5A	-	AH Power Supply Module	None	None	
-	AHCPU530-EN	1.00	Basic CPU module building	None	None	
0	AH04AD-5A	1.00	4 x AI 16bit	D0 ~ D7		AI
1	AH04AD-5A	1.00	4 x AI 16bit	D8 ~ D15		AI
2						

*. Some intelligent modules can be set by means of exclusive configuration tools. Please refer to section 8.3.4 for more information.

8.1.2.8 Cutting/Pasting a Module

There are two ways to cut a module. (The CPU module and the power supply module can not be cut/pasted.)

● **Method 1**

Right-click a module which will be cut in the system configuration area or on the information list, and then click **Cut** on the context menu.

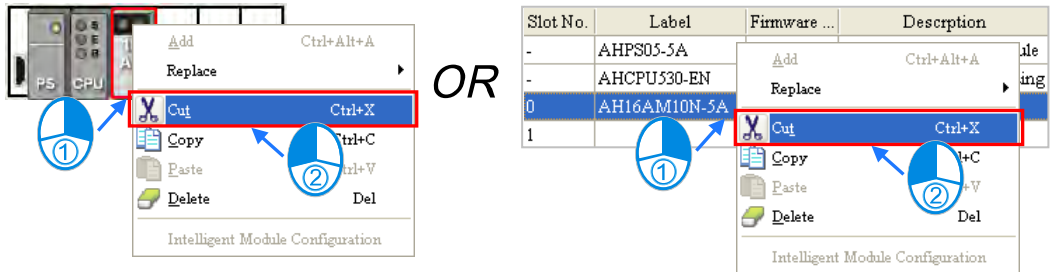

● **Method 2**

(1) Click a module which will be cut in the system configuration area or on the information list.

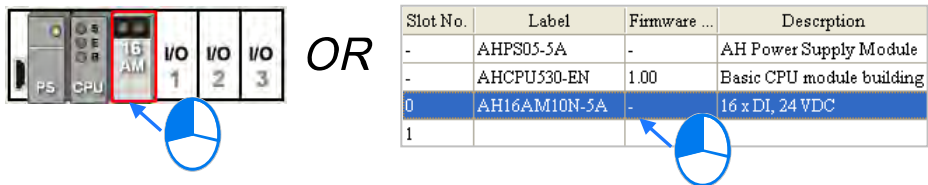

(2) Click **Cut** on the **Edit** menu, or  on the toolbar.

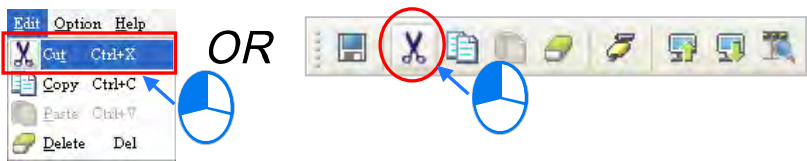

There are two ways to paste a module.

● **Method 1**

Right-click a slot on which a module will be pasted in the system configuration area or on the information list, and then click **Paste** on the context menu.

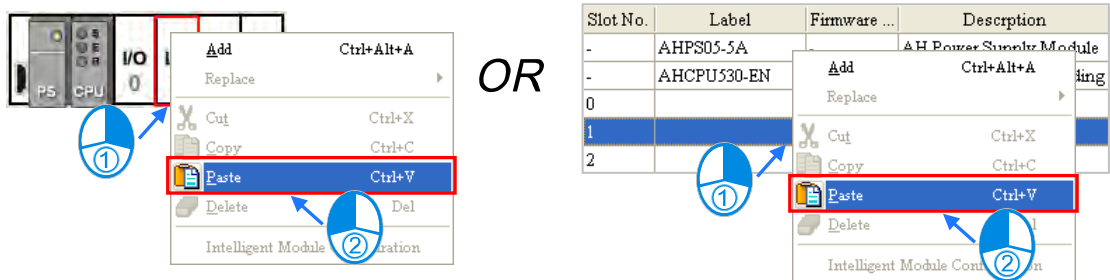

8

● **Method 2**

- (1) Click a slot on which a module will be pasted in the system configuration area or on the information list.

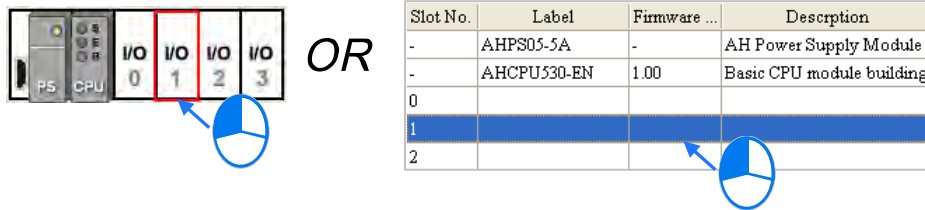

- (2) Click **Paste** on the **Edit** menu, or  on the toolbar.

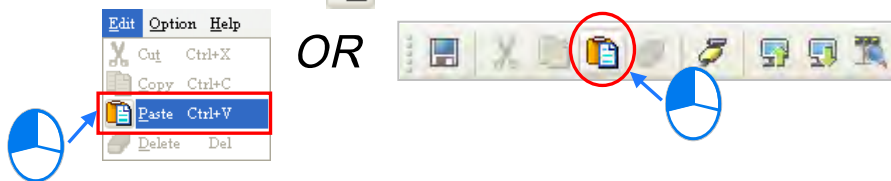

Additional remark

A module which is cut can only be pasted once. When a module is cut/pasted, the parameters in the module are processed as follows.

- **Input/Output device range:** The input/output devices assigned to the module cut are automatically assigned to the module pasted.
 - **Comment about the module:** The comment about the module cut is copied into the module pasted.
 - **Parameters in the module:** The parameters in the module cut are copied into the module pasted.
 - **Data registers:** The data registers assigned to the module cut are automatically assigned to the module pasted.
 - **Parameters in the intelligent module:** The setting of the parameters in the intelligent module is copied.
- *. Some intelligent modules can be set by means of exclusive configuration tools. Please refer to section 8.3.4 for more information.

8.1.2.9 Dragging a Module

All modules in the system configuration area can be dragged by the mouse except the CPU module and the power supply module.

● **Condition 1**

Drag a module to a vacant slot when the left mouse button is held. The module will be moved to a new position.



● **Condition 2**

Drag a module to an occupied slot when the left mouse button is held. The two modules will be interchanged.

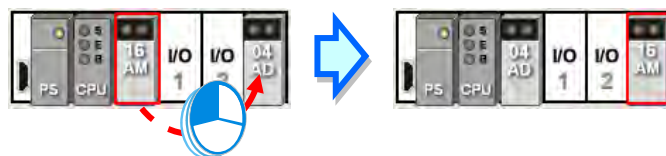

* When a module is dragged, the input/output devices assigned to the module, the comment about the module, the

parameters in the module, the data registers assigned to the module, and the parameters in the intelligent module are also dragged.

8.1.2.10 Adding an Extension Rack

There are two ways to add an extension module.

- **Method 1**

Drag an extension rack which will be added to the product list to the system configuration area. After the extension rack is dragged to the blank in the system configuration area, it will be under the present rack.

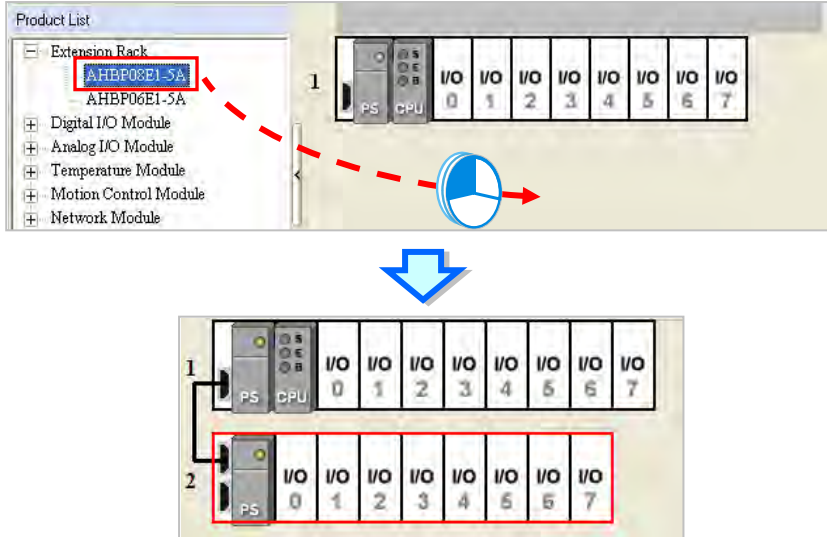

If an extension rack is dragged to a present rack, it will be put above the present rack.

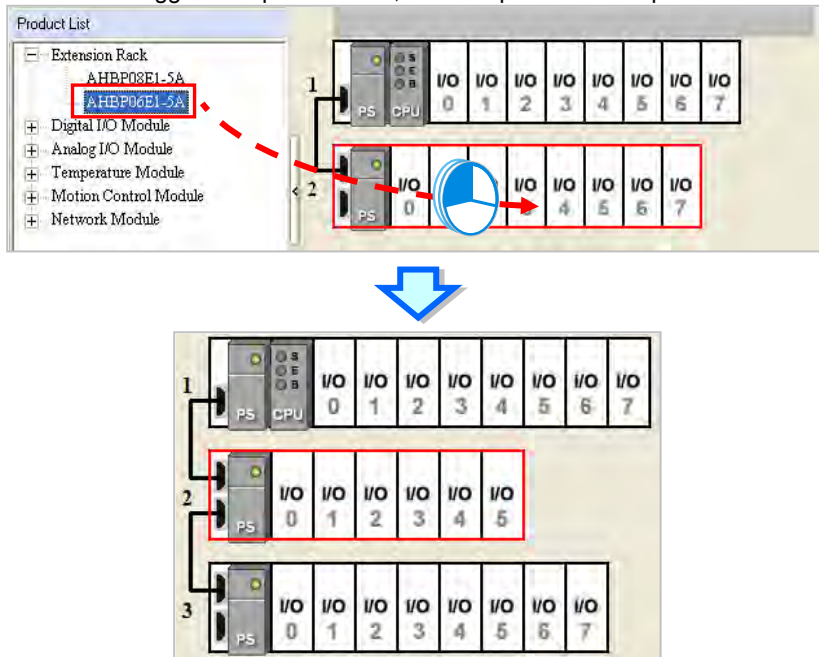

*. An extension rack can not be put above the main rack.

● **Method 2**

Right-click the blank in the system configuration area, click **Add** on the context menu, and double-click an extension rack which will be added in the **Rack Selection** window. The extension rack will be under the present rack.

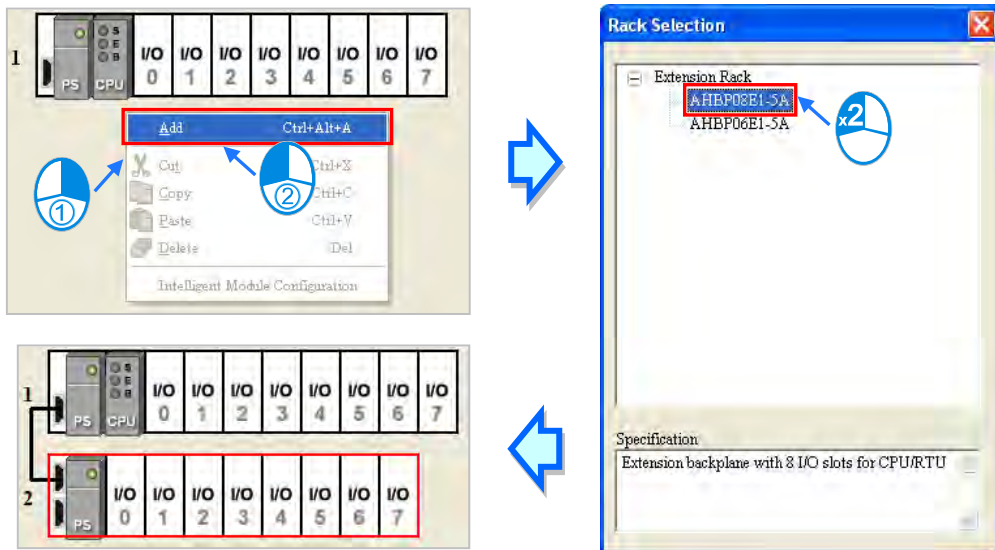

Right-click the left side of a rack, click **Add** on the context menu, and double-click an extension rack which will be added in the **Rack Selection** window. The extension rack will be under the rack.

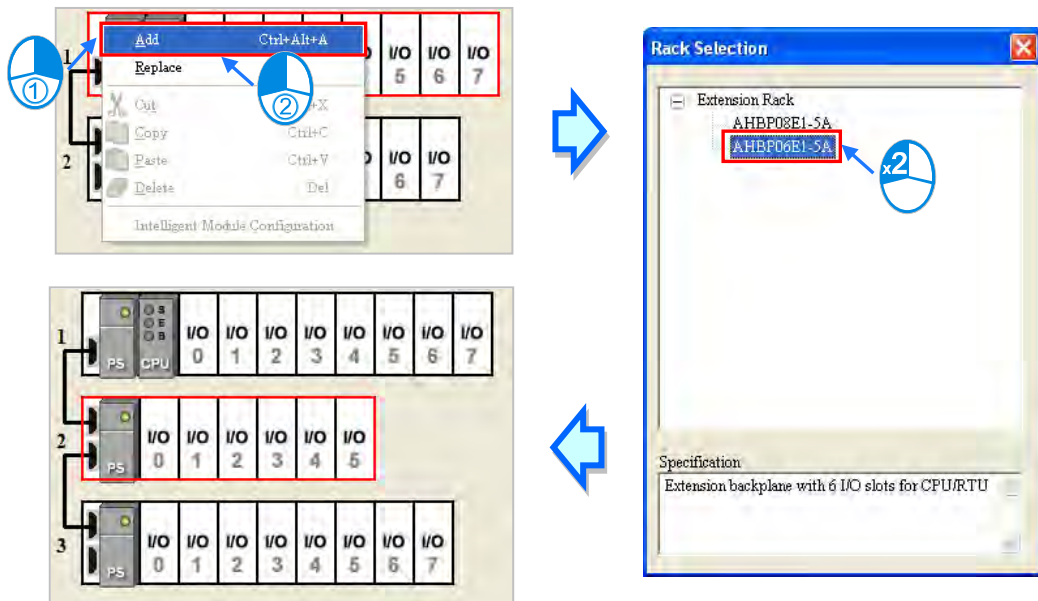

8.1.2.11 Deleting a Rack

There are two ways to delete a rack. (The main extension rack can not be deleted.)

● **Method 1**

(1) Click the left side of a rack which will be deleted.

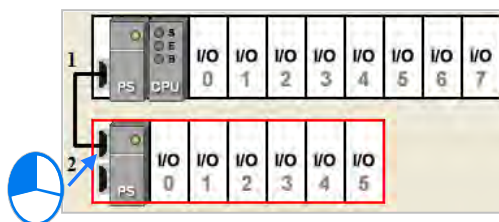

(2) Click **Delete** on the **Edit** menu, click  on the toolbar, or press Delete on the keyboard.

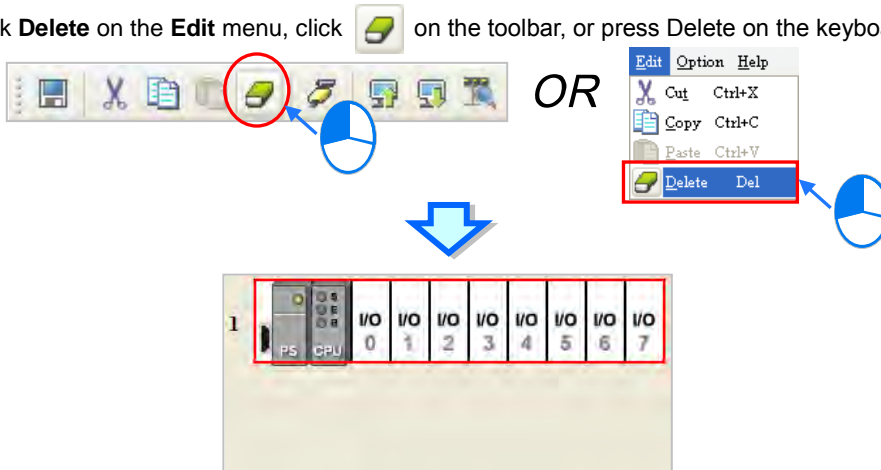

● **Method 2**

Right-click the left side of a rack which will be deleted, and then click **Delete** on the context menu.

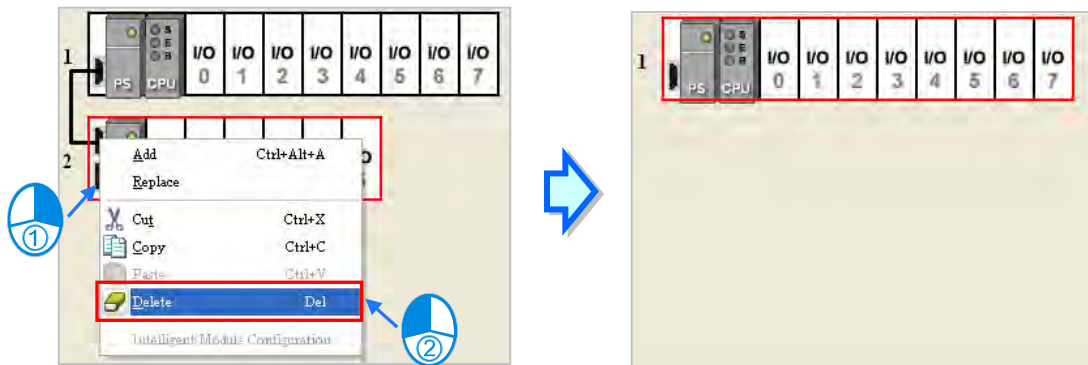

8.1.2.12 Replacing a Rack

(1) Right-click the left side of a rack which will be replaced, and then click **Replace** on the context menu.

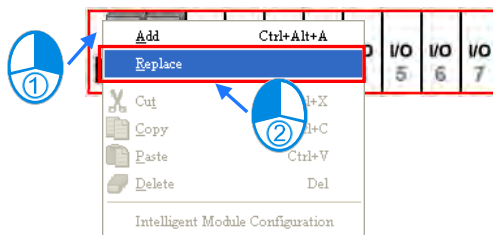

(2) Double-click a rack in the **Rack Selection** window.

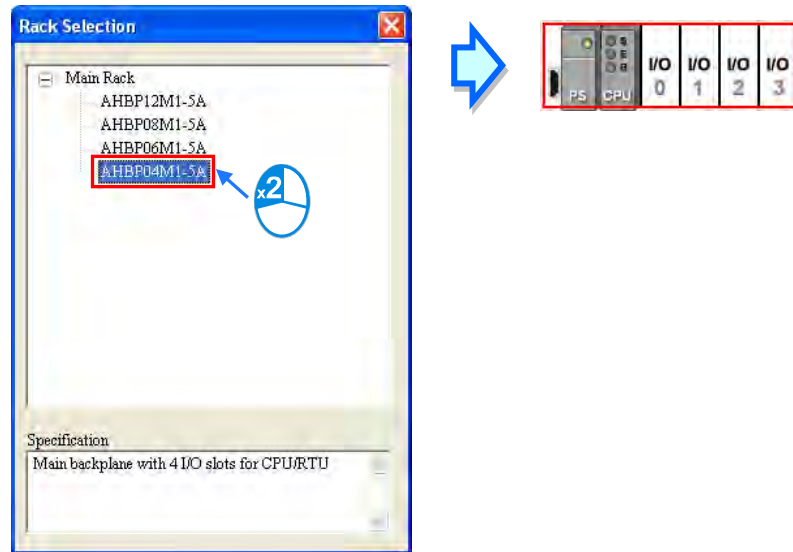

Additional remark

If the number of slots on the new rack is less than the number of slots on the original rack, the modules on the original rack which can not be installed on the new rack will be deleted automatically. As a result, users have to make sure of the number of slots on the new rack before they replace a rack.

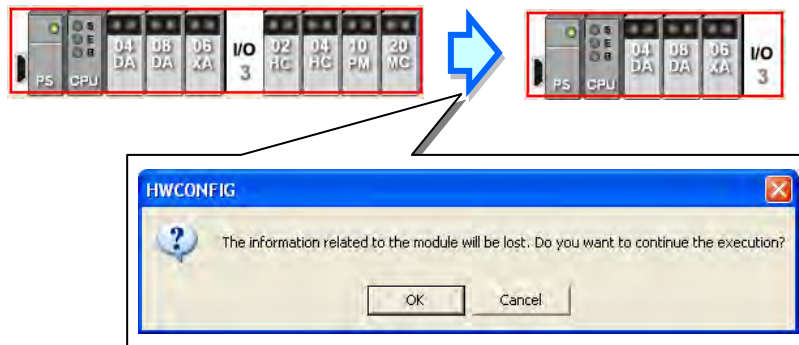

8.1.2.13 Cutting/Copying/Pasting an Extension Rack

There are two ways to copy or cut an extension rack. (The main rack can not be copied/cut/pasted.)

● **Method 1**

Right-click the left side of a rack which will be copied or cut, and then click **Copy** or **Cut** on the context menu.

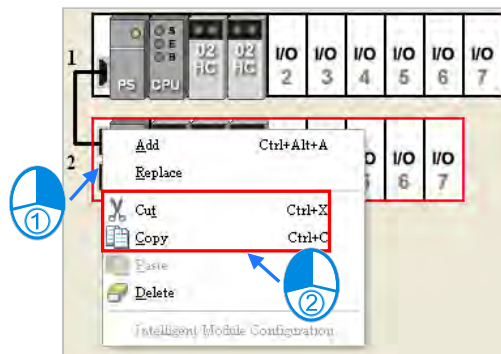

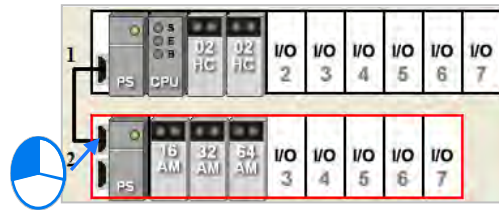

● **Method 2**

Click the left side of a rack which will be copied or cut.

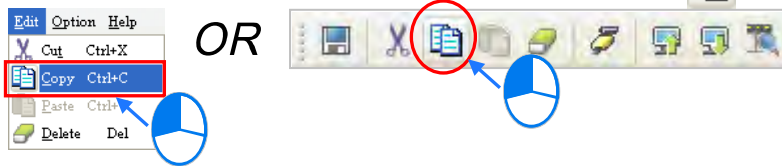

If users want to copy the rack, they can click **Copy** on the **Edit** menu, or click  on the toolbar.



If users want to cut the rack, they can click **Cut** on the **Edit** menu, or click  on the toolbar.

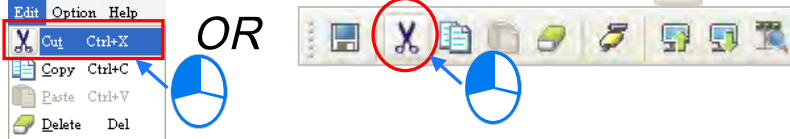

There are two ways to paste an extension rack. If an extension rack is pasted on the blank in the system configuration area, it will be under the present racks. If an extension rack is pasted on a present extension rack, it will be put above the present extension rack.

● **Method 1**

Right-click the blank or a present rack in the system configuration area, and then click **Paste** on the context menu.

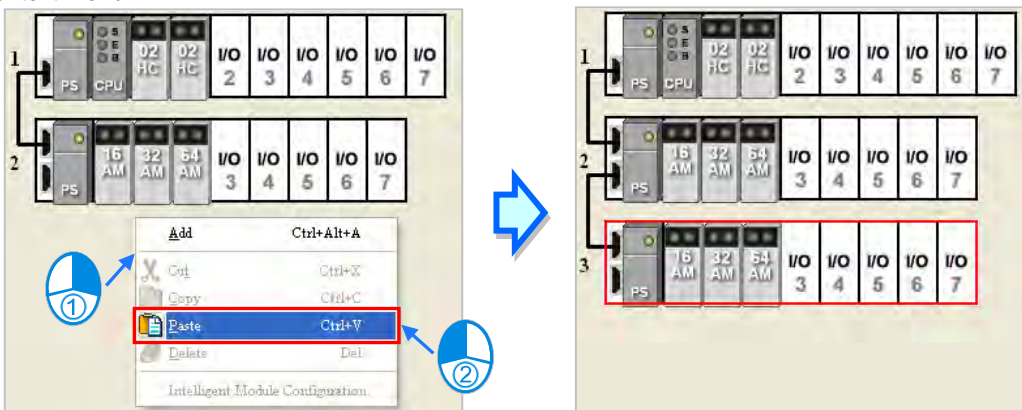

● **Method 2**

Click the blank or a present rack in the system configuration area, and then click **Paste** on the **Edit** menu, or  on the toolbar.

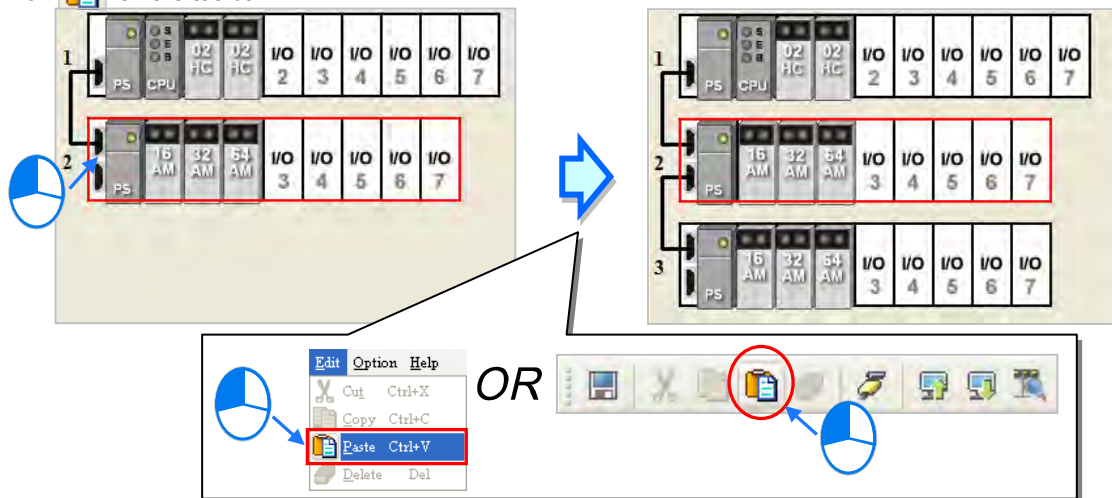

Additional remark

When an extension rack is cut/pasted, the parameters in the modules on the extension rack are processed as follows.

- **Input/Output device range:** The input/output devices assigned to the modules on the extension rack cut are automatically assigned to the modules on the extension rack pasted.
 - **Comments about the modules:** The comments about the modules on the extension rack cut are copied into the modules on the extension rack pasted.
 - **Parameters in the modules:** The parameters in the modules on the extension rack cut are copied into the modules on the extension rack pasted.
 - **Data registers:** The data registers assigned to the modules on the extension rack cut are automatically assigned to the modules on the extension rack pasted.
 - **Parameters in the intelligent modules:** The setting of the parameters in the intelligent modules is copied.
- When an extension rack is copied/pasted, the parameters in the modules on the extension rack are processed as follows.
- **Input/Output device range:** The input/output device addresses assigned to the modules on the extension rack pasted follow the input/output device addresses assigned to the modules on the extension rack copied.
 - **Comments about the modules:** The comments about the modules on the extension rack copied are copied into the modules on the extension rack pasted.
 - **Parameters in the modules:** The parameters in the modules on the extension rack cut are copied into the modules on the extension rack pasted.
 - **Data registers:** The data register addresses assigned to the modules on the extension rack pasted follows the data registers addresses assigned to the modules on the extension rack copied.
 - **Parameters in the intelligent modules:** The setting of the parameters in the intelligent modules is not copied, and is restored to the default values.

*. Some intelligent modules can be set by means of exclusive configuration tools. Please refer to section 8.3.4 for more information.

8.1.2.14 Dragging an Extension Rack

Drag an extension rack to another extension rack when the left mouse button is held. The two extension racks will be interchanged. When the extension rack is dragged, the input/output devices assigned to the modules on the extension rack, the comments about the modules on the extension rack, the parameters in the modules on the extension rack, the data registers assigned to the modules on the extension rack, and the parameters in the intelligent modules are also dragged. However, the main rack is always at the top of the system configuration area.

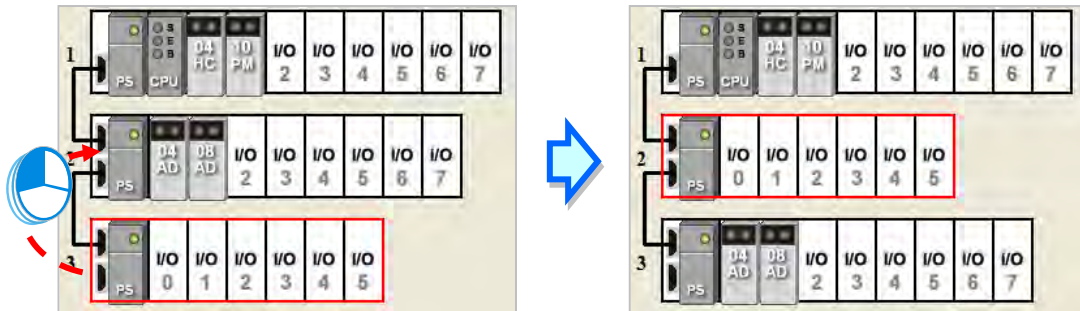

8.1.2.15 Rearranging the Input/Output Devices

During a module configuration, modules may be dragged or copied/cut/pasted several times. The input/output devices may be automatically assigned to the modules by the system, and may not be arranged in order. After users click **Input/Output Device Rearrange** on the **File** menu, the input/output devices assigned to all modules will be rearranged according to the slot numbers and the rack numbers.

The rearrangement of the input/output devices does not change the data registers assigned to the modules. During the rearrangement, if the input/output devices assigned to the modules conflicts with the data registers assigned to the modules, the system will skip the data registers assigned to the module, and provide the devices which can be used.

Slot No.	Label	Firmware ...	Description	Input Device ...	Output Device ...	Comment
-	AHPS05-5A	-	AH Power Supply Module	None	None	
-	AHCPU530-EN	1.00	Basic CPU module building	None	None	
0	AH04AD-5A	1.00	4 x AI 16bit	D64 ~ D71		
1	AH04AD-5A	1.00	4 x AI 16bit	D16 ~ D23		
2	AH04DA-5A	1.00	4 x AO 16bit		D32 ~ D39	
3	AH04DA-5A	1.00	4 x AO 16bit		D88 ~ D95	

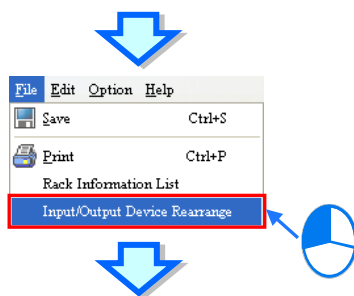

Slot No.	Label	Firmware ...	Description	Input Device ...	Output Device ...	Comment
-	AHPS05-5A	-	AH Power Supply Module	None	None	
-	AHCPU530-EN	1.00	Basic CPU module building	None	None	
0	AH04AD-5A	1.00	4 x AI 16bit	D0 ~ D7		
1	AH04AD-5A	1.00	4 x AI 16bit	D8 ~ D15		
2	AH04DA-5A	1.00	4 x AO 16bit		D16 ~ D23	
3	AH04DA-5A	1.00	4 x AO 16bit		D24 ~ D31	

8.2 Setting the Parameters in an AH500 Series CPU Module

The following software snapshots are from AH500 basic series CPU modules (AHCPU500/510/520/530).

8.2.1 Opening the PLC Parameter Setting Window

After users double-click the CPU module in the system configuration area, the **PLC Parameter Setting** window will appear. The parameters which can be set vary with the models of the CPU modules.

⚠ Before the parameters in a CPU module are set, users have to refer to the operation manual for the CPU module. To prevent damage to the system or staff, the users have to make sure of the effect that the parameters which are set have on the CPU module and the whole system.

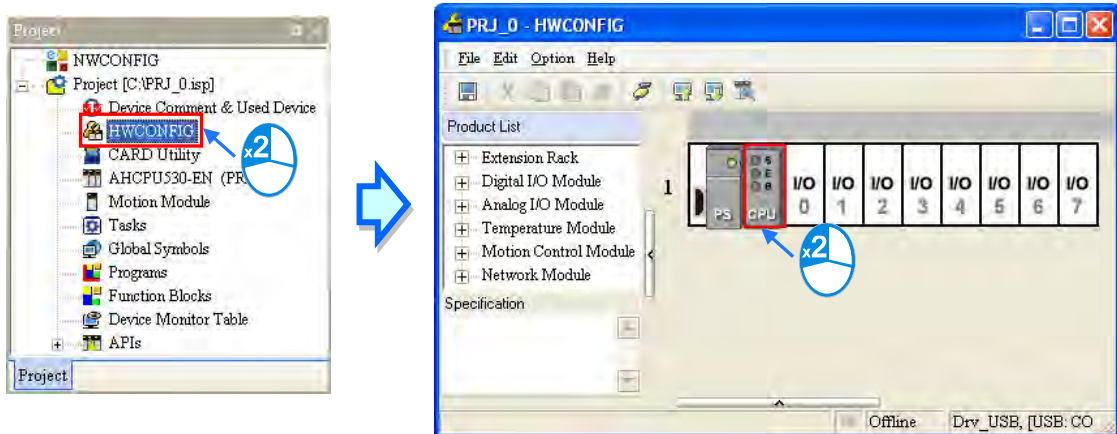

The parameters are classified into several types. The users can click the primary tabs at the top of the window, and the secondary tables at the bottom of the window to set the parameters.

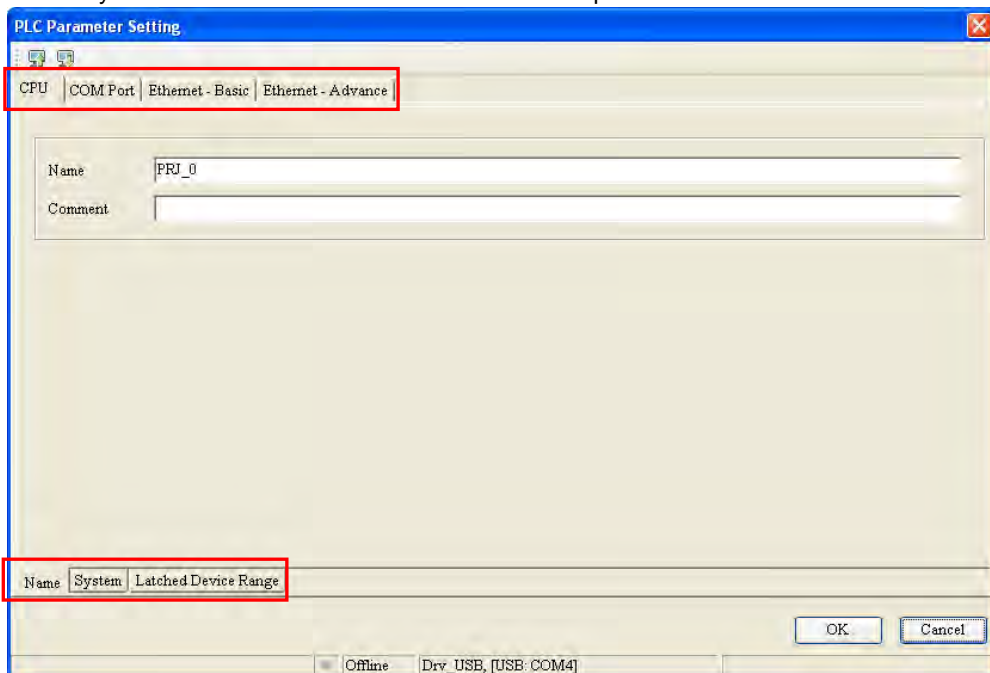

8.2.2 Setting the Basic CPU Parameters

8.2.2.1 CPU: Name

After users click the **CPU** tab at the top of the window, and the **Name** tab at the bottom of the window, they can type 32 characters at most in the **Name** box, and 60 characters at most in the **Comment** box. There is no restriction on characters which can be typed in the boxes. Characters typed in the boxes can include special marks and spaces. However, the users have to notice that a Chinese character occupies two characters.

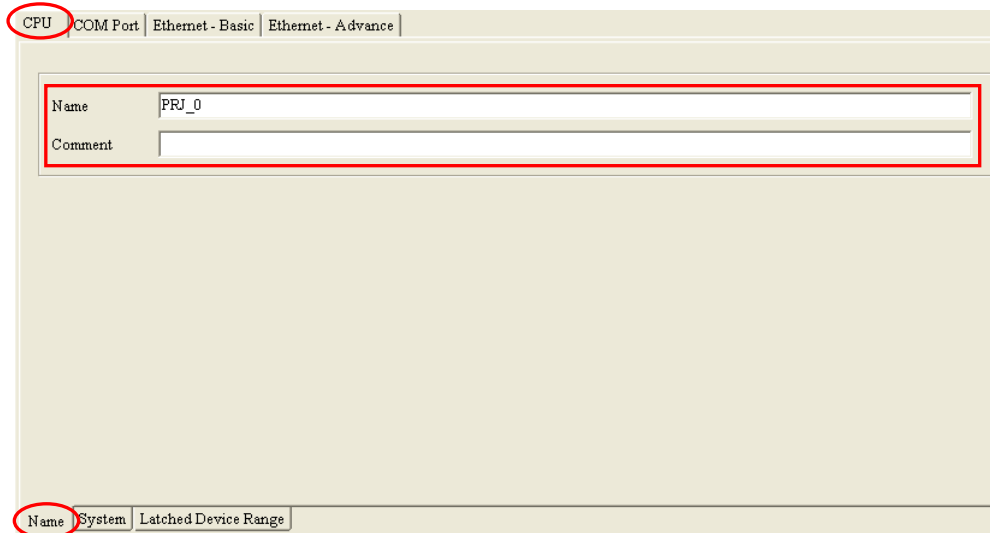

After an ISPSOFT project is created, the project name will be taken as the default name of the CPU module, and the default name of the CPU module will be attached to the model in the project management area. Users can change the default name of the CPU module in the **Name** box later.

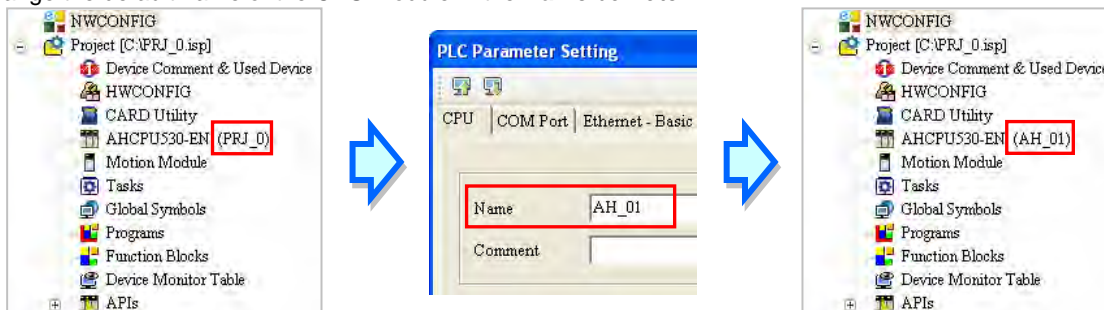

Users can identify a device by means of the name of the device. When several devices are connected on a network, users can check whether a device connected to the computer is the device they expect by means of the name of the device. To prevent unexpected effect on other CPU modules, if users want to download/upload the program, but the name of the CPU module is different from the name attached to the model in the project management area, the system will remind the users to check the name of the CPU module and the name attached to the model in the project management area.

***. The parameters set in HWCONFIG must be downloaded to the CPU module so that they can take effect. (Please refer to section 8.2.6 or section 8.4.4 for more information.)**

8.2.2.2 CPU: System

After users click the **CPU** tab at the top of the window, and the **System** tab at the bottom of the window, they can set the parameters in the CPU module.

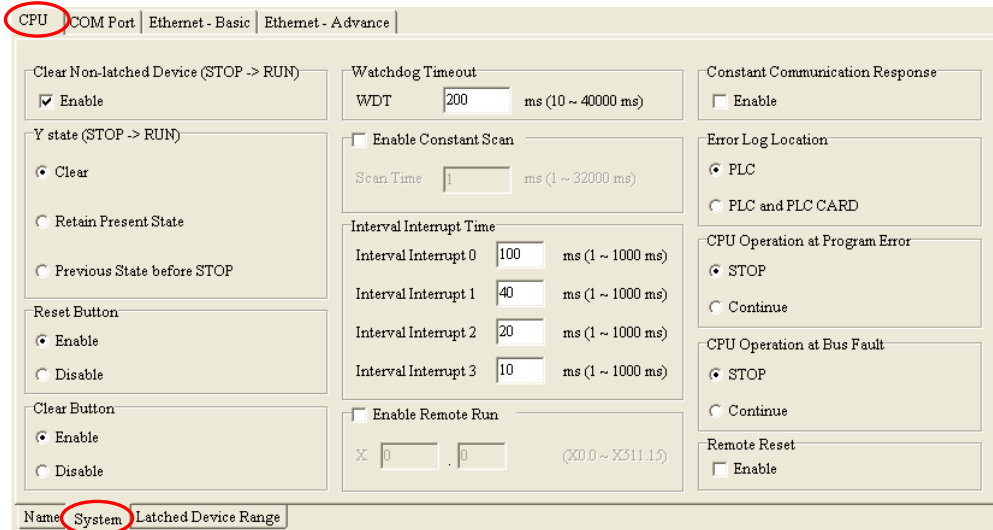

- **Clear Non-latched Device (STOP→RUN)**

If the **Enable** checkbox is selected, the states of the non-latched devices, and the values in the non-latched devices are cleared when the CPU module begins to run.

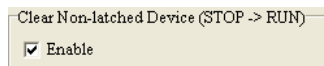

- **Y state (STOP→RUN)**

When the CPU module begins to run, the states of the Y devices are OFF, retained, or restored to the states before the CPU module's stopping running.

- **Clear:** All Y devices are set to OFF.
- **Retain Present State:** The **states** of the Y devices are retained.
- **Previous State before STOP:** The states of the Y **devices** are restored to the states before the CPU module's stopping running.

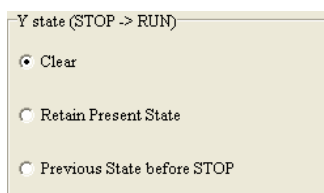

- **Reset Button & Clear Button**

Whether the RST button and CLR button on the CPU module is enabled or disabled depends on the setting of these parameters. Please refer to an operation manual for more information about the functions of the buttons.

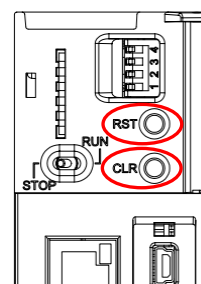
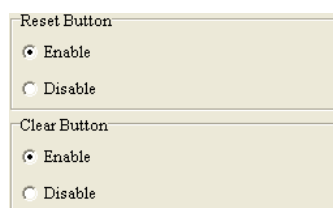

● **Watchdog Timeout**

Users can set a timeout during which the program is scanned. Generally speaking, the watchdog timeout is reset whenever the scan of the program is complete. If the scan procedure can not be completed within the time set for some reason, the watchdog timeout occurs, and the CPU module will be in an erroneous condition. Please refer to operation manuals for more information about troubleshooting.



● **Enable Constant Scan**

Users can select the **Enable Constant Scan** checkbox, and set a scan time. If the actual scan time is less than setting value, the CPU module will not carry out the next scan until the setting value is reached. If the actual scan time is larger than the setting value, the CPU module will ignore the setting value, and operate according to the actual scan time. Besides, if the scan time set is larger than the watchdog timeout set, a watchdog timeout occurs when the CPU module operates.

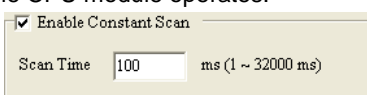

● **Interval Interrupt Time**

An AH500 series CPU module provides four interrupts. Users can set intervals of triggering the interrupts. In ISPSOft, a timed interrupt is created through a task and a POU. Please refer to chapter 5 in ISPSOft User Manual for more information.

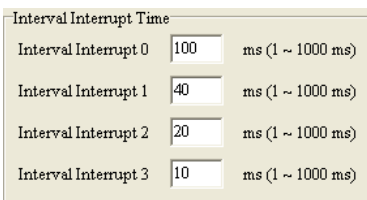
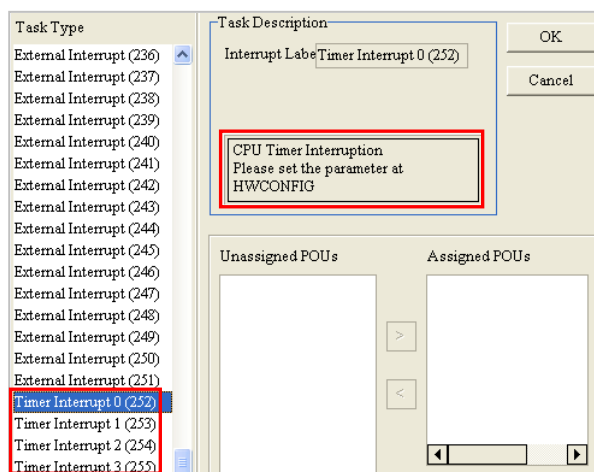
● **Enable Remote Run**

If the **Enable Remote Run** checkbox is selected, users can specify an X device which controls the status of the CPU module. For example, the CPU module runs when the state of X0.0 is ON, and the CPU module stops running when X0.0 is OFF.

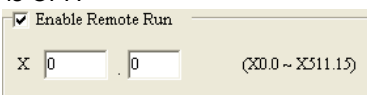

- **Constant Communication Response**

If the **Enable** checkbox is not selected, commands received through the communication ports will not be processed until the scan cycle is complete. If the **Enable** checkbox is selected, commands received through the communication ports will be processed every specific period of time. However, the scan procedure is interrupted when the system processes commands received through the communication ports. As a result, the scan time will be prolonged if the **Enable** checkbox is not selected. Please make sure that the operation of the system is not affected when the function is used.

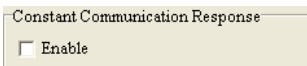

- **Error Log Location**

If the **PLC** option button is selected, error logs will be stored in the special data registers in the CPU modules. If the **PLC and PLC CARD** option button is selected, error logs will be stored not only in the CPU module, but also in the memory card.

Twenty error logs at most can be stored in an AH500 series CPU module. If there are more than twenty error logs, the oldest error log will be overwritten by the latest error log. However, if the **PLC and PLC CARD** option button is selected, and there are more than twenty error logs, the oldest error log will be backed up in the memory card before the oldest error log is overwritten.

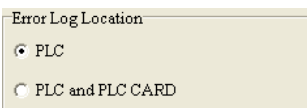

- **CPU Operation at Program Error & CPU Operation at Bus Fault**

If an error occurs, the status of the CPU may change. The status of the CPU depends on an error code generated. Users can define the status of the CPU module for some errors. They can select the **Stop** option button or the **Continue** option button in the **CPU Operation at Program Error** section, select the **Stop** option button or the **Continue** option button in the **CPU Operation at Bus Fault** section, and download the parameters to the CPU module. Please refer to operation manuals or related technical documents for more information.

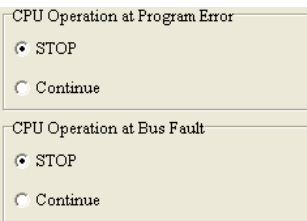

- **Remote Reset**

If the **Enable** checkbox is selected, the CPU module can be reset through a remote system. After users select the **Enable** checkbox, and download the parameter to the CPU module, they can click **Format PLC Memory...** on the **PLC** menu, and select the **Reset PLC Memory (Factory Setting)** option button in the **Format PLC Memory** window.

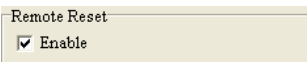

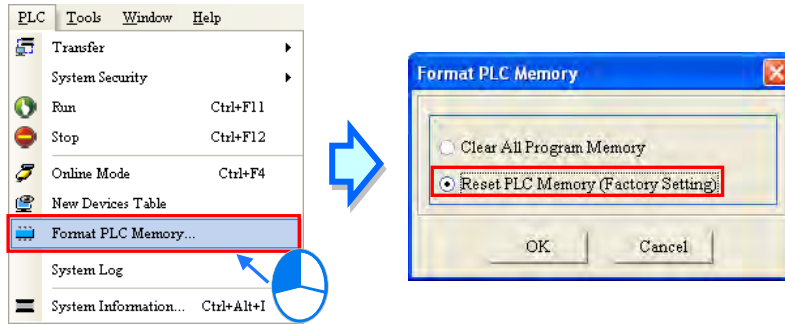

*. The parameters set in HWCONFIG must be downloaded to the CPU module so that they can take effect. (Please refer to section 8.2.6 or section 8.4.4 for more information.)

8.2.2.3 CPU: Latched Device Range

After users click the **CPU** tab at the top of the window, and the **Latched Device Range** tab at the bottom of the window, they can set a range of latched devices.

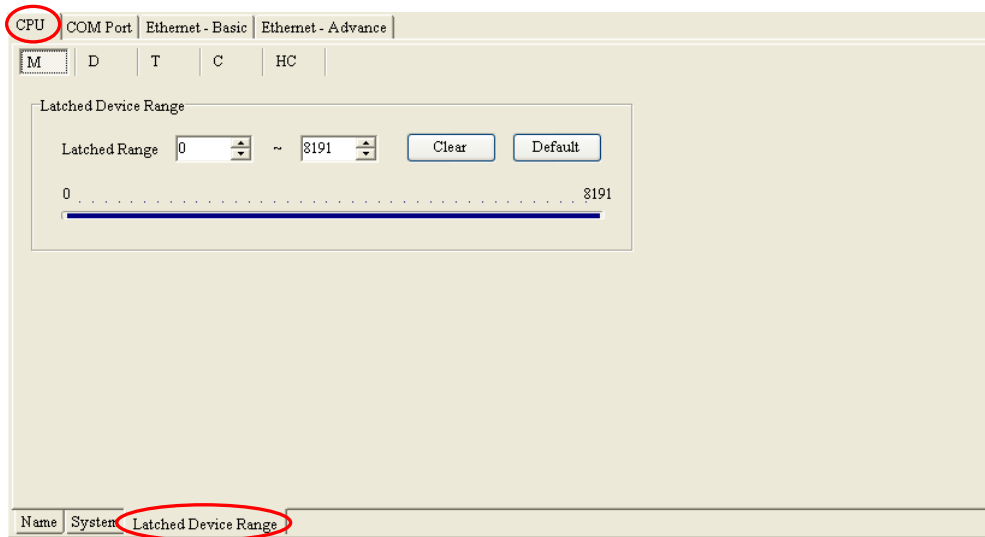

- (1) After users click a device type, they can be set a range of latched devices. There is a rectangular bar in the setting area. The values at the two ends of the bar represent a maximal value and a minimal value. The blue part represents a range of latched devices.

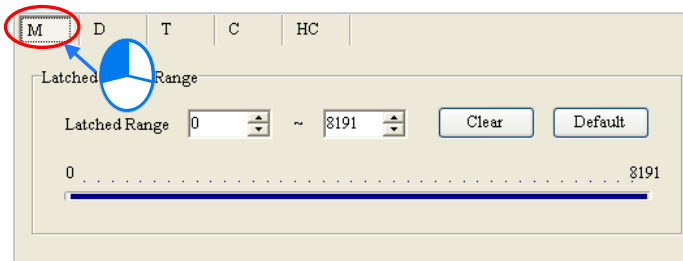

8

- (2) Please select values in the boxes. The value in the left box is a start address, and the value in the right box is an end address. The value in the left box must be less than the value in the right box. Besides, the value in the left box can not be less than the minimal value at the left end of the rectangular bar, and the value in the right box can not be larger than the maximal value at the right end of the rectangular bar.

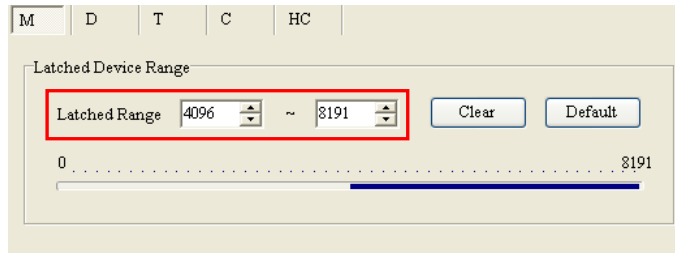

- (3) If all the devices in the block are not latched devices, the users can click **Clear**. After the users click **Clear**, the boxes become gray, and the range of latched devices will be -1~-1.

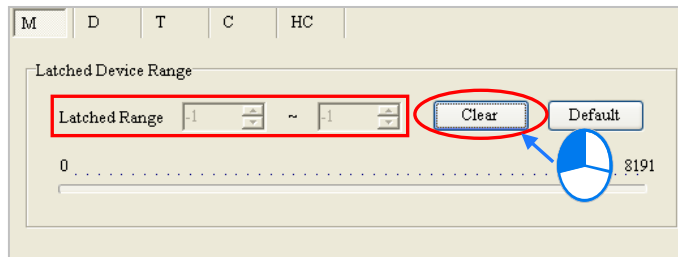

- (4) If the users want to restore the setting to the default values, they can click **Default**. After the users click **Default**, the setting will be restored to the default values.

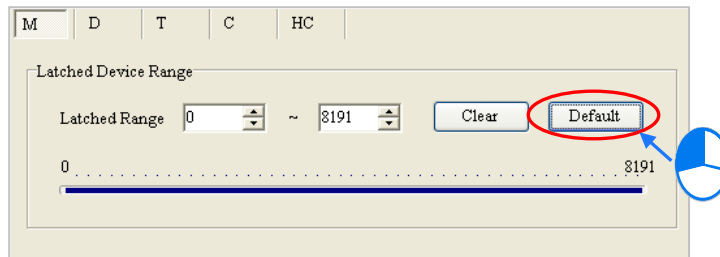

Additional remark

A range of latched devices of a certain type may not include all the devices of that type. If there is restriction on the maximum number of latched devices of a certain type, a related hint will be under the setting area. In the setting page for the data registers in AHCPU530-EN, the hint indicates that the maximum number of latched data registers is 32768. In other words, in the range of 0 to 65535, the number of latched data registers should be less than or equal to 32768, e.g. 0~32767 or 10000~42767.



In the setting page below, the range of latched data registers is D0~D32768. The number of latched data registers is 32769. When users leave this page, the **PLC Parameter Setting** dialog box appears.

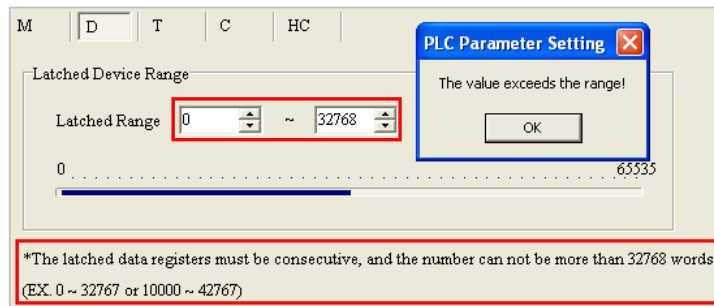

*. The parameters set in HWCONFIG must be downloaded to the CPU module so that they can take effect. (Please refer to section 8.2.6 or section 8.4.4 for more information.)

8.2.3 COM Port

After users click the **COM Port** tab at the top of the window, they can set the communication ports in the CPU module. If the CPU module is equipped with two communication ports, there are two setting areas for the two communication ports, and the two communication ports are set individually. (AHCPU5xx-RS2 is equipped with two communication ports.)

Please refer to section 2.4.7 in ISPSOft User Manual for more information about connecting to a CPU module through a communication port.

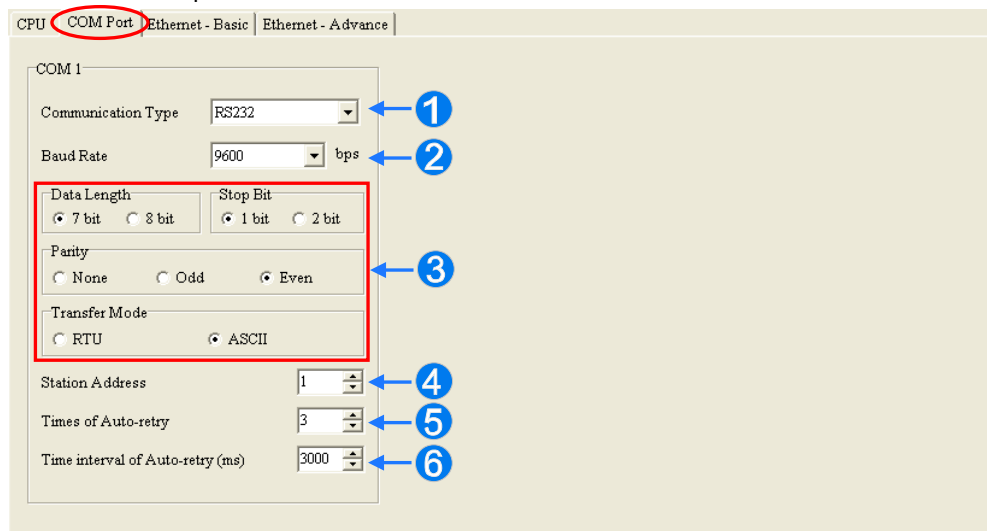

8

- ① Users can select **RS232**, **RS485**, or **RS422** in the **Communication Type** drop-down list box.
- ② Users can select a communication speed in the **Baud Rate** drop-down list box. If a RS-232 cable is used, the communication speed can be 9600 bps, 19200 bps, 38400 bps, 57600 bps, 115200 bps. If a RS-485 cable or a RS-422 cable is used, the communication speed can be 9600 bps, 19200 bps, 38400 bps, 57600 bps, 115200 bps, 230400 bps, 460800 bps, or 921600 bps.
- ③ Users can set the communication protocol parameters. If the **RTU** option button is selected in the **Transfer Mode** section, the **8 bit** option button in the **Data Length** section is automatically selected.
- ④ Users can set a station address. A device on a network can be identified by means of the station address of the device. The station address of a device on a network can not be the same as the station address of another device on the same network. The station address of a device must be in the range of 0 to 247. If the communication port functions as a slave, and there are other slaves, the station address of the communication port can not be 0. Station address 0 has the meaning of broadcasting to all slaves in a communication protocol. If a master specifies in a data packet that data must be sent to station address 0, the data will be sent to all slaves. No matter what station address of these slaves are, these slaves will receive the data packet.

- ⑤ If the sending of a command fails, the CPU module will retry the sending of the command. Users can set the number of times the sending of a command is retired in this box. The number of times the sending of a command is retired must be in the range of 0 to 20.
- ⑥ Users can set an interval of retrying the sending of a command. If the sending of a command fails, the CPU module will retry the sending of the command every specific period of time. The interval of retrying the sending of a command must be in the range of 100 milliseconds to 65535 milliseconds.

*. The parameters set in HWCONFIG must be downloaded to the CPU module so that they can take effect. (Please refer to section 8.2.6 or section 8.4.4 for more information.)

8.2.4 Ethernet—Basic

If a CPU module is equipped with an Ethernet port, users can enter this page. For example, AHCPU5xx-EN is equipped with an Ethernet port. After users click the **Ethernet—Basic** tab at the top of the window, they can set the Ethernet port in the CPU module.

The users can set the communication parameters for the Ethernet port in the CPU module in this page. They can refer to section 2.4.7 in ISPSOFT User Manual for more information about connecting to a CPU module through the Ethernet port on the CPU module, and refer to other related documents or manuals for more information about Ethernet.

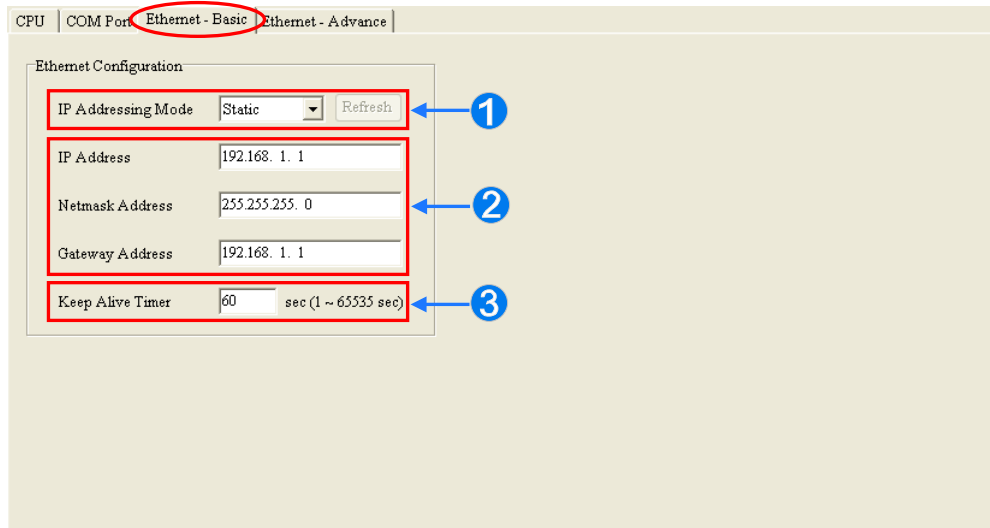

- ① If users select **Static** in the **IP Addressing Mode** drop-down list box, they can specify an IP address. If **Dynamic** is selected in the **IP Addressing Mode** drop-down list box, an IP address is assigned by a DHCP server.
- ② If **Static** is selected in the **IP Addressing Mode** drop-down list box, users can assign an IP address, a subnet mask, and a gateway address.
- ③ If no data is transmitted from the CPU module on a network, and the keepalive period has elapsed, the CPU module will be disconnected from the network automatically.

If **Dynamic** is selected in the **IP Addressing Mode** drop-down list box, the IP address, the subnet mask, and the gateway can be read from the CPU module by means of the following steps.

- (1) Connect the CPU module to Ethernet, and make sure that the network and the CPU module operate normally.
- (2) Select **Dynamic** in the **IP Addressing Mode** drop-down list box, and download the parameter to the CPU module.
- (3) After **Refresh** is clicked, the system will read the IP address, the subnet mask, and the gateway from the CPU module. The IP address, the subnet mask, and the gateway will be displayed in the boxes.

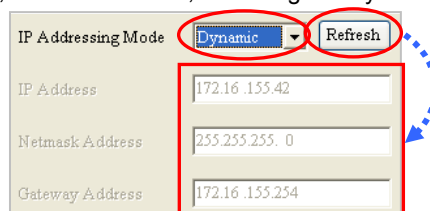

*. The parameters set in HWCONFIG must be downloaded to the CPU module so that they can take effect. (Please refer to section 8.2.6 or section 8.4.4 for more information.)

8.2.5 Ethernet—Advance

If a CPU module is equipped with an Ethernet port, users can enter this page. For example, AHCPU5xx-EN is equipped with an Ethernet port. After users click the **Ethernet—Advance** tab at the top of the window, they can set devices on a network.

8.2.5.1 Ethernet—Advance: Filter

After users click the **Ethernet—Advance** tab at the top of the window, and the **Filter** tab at the bottom of the window, they can set a filter. Devices on a network are filtered. The setting here ensures that objects communicating with the CPU module are devices which are allowed.

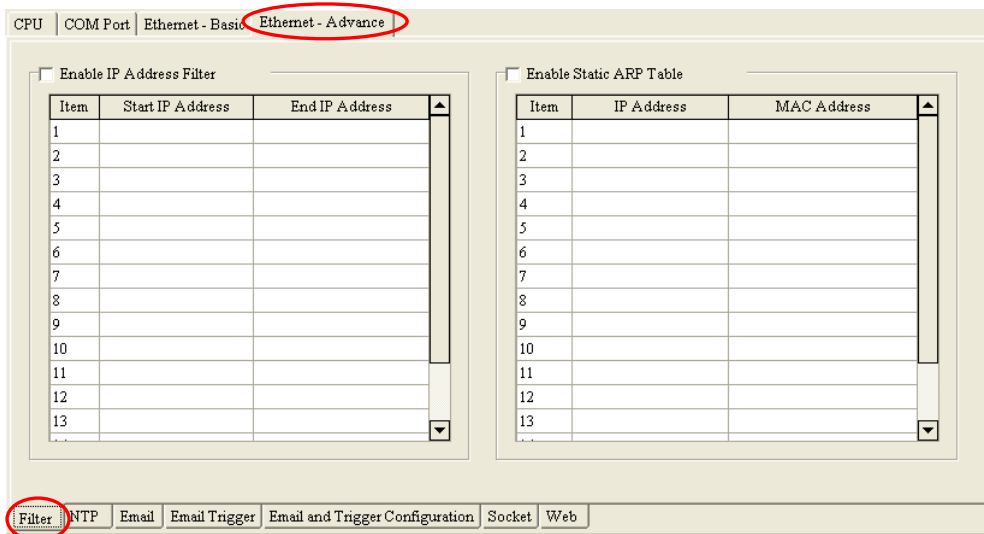

- **Enable IP Address Filter**

If the **Enable IP Address Filter** checkbox is selected, devices whose IP addresses are listed in the table will be allowed to communicate with the CPU module, and the CPU module will discard data packets sent from devices whose IP addresses are not listed in the table. The steps of setting the function are as follows. Sixteen groups of IP address at most can be listed in the table.

- (1) Select the **Enable IP Address Filter** checkbox, and then double-click an item which will be modified or added in the table.

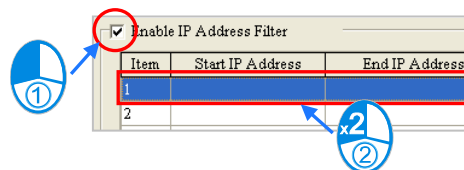

- (2) Type a start IP address and an end address in the **IP address Filter** window. The start IP address must be less than the end IP address. Finally, click **OK**.

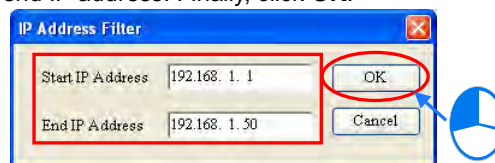

- **Enable Static ARP Table**

Users can use this function to set MAC addresses and corresponding IP addresses. The MAC address of every device is unique. If the MAC address of device A is known, the MAC address can be bound to the IP address assigned to device A. The CPU module will regard the IP address as the exclusive address of

device A. Even if device B is assigned the same IP address, the CPU module does not respond to device B. The steps of setting the function are as follows. Sixteen groups of addresses at most can be listed in the table.

- (1) Select the **Enable Static ARP Table** checkbox, and then double-click an item which will be modified or added in the table.

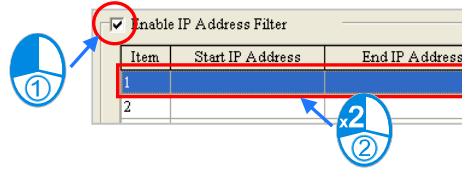

- (2) Type an IP address and a MAC address in the **Static ARP Table** window. Finally, click **OK**.

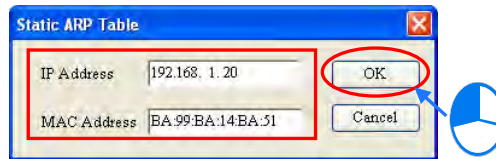

Take the tables below for example. After the setting in the tables is downloaded to the CPU module, devices whose IP addresses are in the range of 192.168.1.1 to 192.168.1.50, and devices whose IP addresses are in the range of 192.168.1.100 to 192.168.1.150 are allowed to communicate with the CPU module if the CPU module operates. Besides, if the CPU module communicates with a device whose IP address of 192.168.1.20, the MAC address of the device must be BA:99:BA:14:BA:51. Likewise, if the CPU module communicates with a device whose IP address is 192.168.1.21, the MAC address of the device must be 00:10:5A:81:CA:FD.

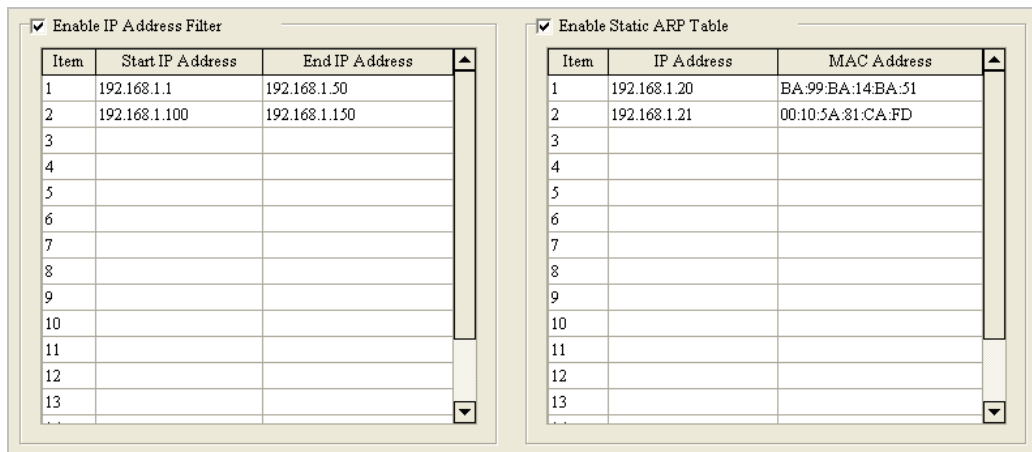

- *1. The parameters set in HWCONFIG must be downloaded to the CPU module so that they can take effect. (Please refer to section 8.2.6 or section 8.4.4 for more information.)
- *2. If users want to know the MAC address of a CPU module, they can click Online Mode in HWCONFIG to view the information about the CPU module (section 8.4.6), or click System Information in ISPSOFT to get the information about the CPU module connected and the status of the CPU module (section 14.5.1 in ISPSOFT User Manual).



8.2.5.2 Ethernet–Advance: NTP

After users click the **Ethernet–Advance** tab at the top of the window, and the **NTP** tab at the bottom of the window, they can enable the function of synchronizing the real-time clock in the CPU module to an NTP server, and carry out the related setting. NTP will not be introduced here. Please refer to related documents or manuals for more information about NTP.

The screenshot shows the 'Ethernet-Advance' configuration window. At the top, the 'Ethernet-Advance' tab is selected. Below it, the 'Enable NTP Client Service' checkbox is unchecked. The 'NTP Server' field contains '192.168.1.1'. The 'Update Cycle' is set to '30' minutes. The 'Daylight Saving' section is also unchecked. The 'Start Date' is '1 / 2', 'End Date' is '3 / 4', and 'Time' is '0 O'Clock'. The 'Time Zone' is '(GMT-12:00) Eniwetok, Kwajalein'. At the bottom, the 'NTP' tab is selected.

Select the **Enable NTP Client Service** checkbox, and then set the related parameters.

The screenshot shows the 'Ethernet-Advance' configuration window with the 'Enable NTP Client Service' checkbox checked. The 'NTP Server' is '192.168.1.1', 'Update Cycle' is '30' minutes, and 'Daylight Saving' is checked. The 'Start Date' is '5 / 1', 'End Date' is '9 / 1', and 'Time' is '0 O'Clock'. The 'Time Zone' is '(GMT-12:00) Eniwetok, Kwajalein'. Blue arrows and numbers 1-4 point to the NTP Server, Update Cycle, Daylight Saving section, and Time Zone respectively.

- ❶ Users can set the IP address of an NTP server. The CPU module corrects the time inside itself by connecting to the server periodically.
- ❷ Users can set an interval of correcting the time in the CPU module. If the interval is thirty minutes, the CPU module will connect to the NTP server every thirty minutes.
- ❸ After users select the **Daylight Saving** checkbox, they can select a start date and an end data.
- ❹ Users can select a time zone in the **Time Zone** drop-down list box.

*. The parameters set in HWCONFIG must be downloaded to the CPU module so that they can take effect. (Please refer to section 8.2.6 or section 8.4.4 for more information.)

8.2.5.3 Ethernet–Advance: Email

After users click the **Ethernet–Advance** tab at the top of the window, and the **Email** tab at the bottom of the window, they can set the mail sending function.

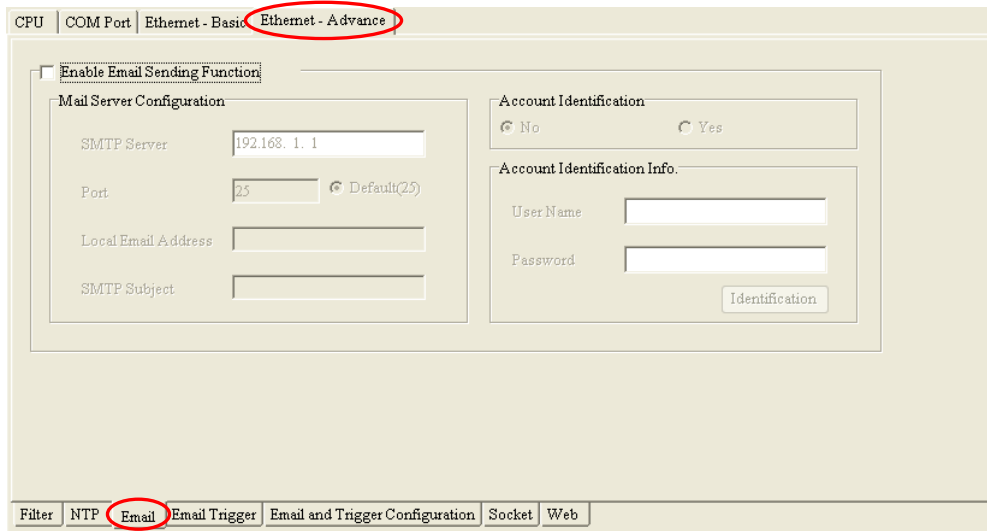

After users select the **Enable Email Sending Function** checkbox, they can set the related parameters.

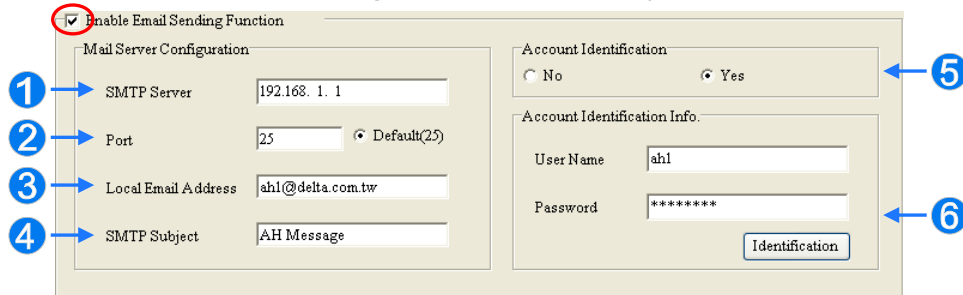

- ❶ **SMTP Server:** Users can set the IP address of an SMTP server.
- ❷ **Port:** Users can set a port for an SMTP server, or select the **Default (25)** option button.
- ❸ **Local Email Address:** Users can set the address of an actual sender. A local email address is composed of 64 characters at most.
- ❹ **SMTP Subject:** Data typed in the **SMTP Subject** box will be put at the front part of the subject of every email. Only English letters, numerical digits, and special marks can be typed in the box. The subject of an email is composed of 16 characters at most.
- ❺ **Account Identification:** If users want to authenticate themselves with a user name and a password before logging in to an SMTP server, they can select the **Yes** option button.
- ❻ **Account Identification Info.:** Users can type a user name and a password which are used for authentication. A user name is composed of 16 characters at most, and a password is also composed of 16 characters at most. If the parameters above are set correctly, and the computer can connect to an SMTP server normally, users can click **Identification** to test whether the user name and the password are correct.

*. The parameters set in HWCONFIG must be downloaded to the CPU module so that they can take effect. (Please refer to section 8.2.6 or section 8.4.4 for more information.)

8.2.5.4 Ethernet–Advance: Email Trigger

After users click the **Ethernet–Advance** tab at the top of the window, and the **Email Trigger** tab at the bottom of the window, they can set triggers for the sending of emails. Before setting triggers, users have to click the **Email** tab, and select the **Enable Email Sending Function** checkbox. Please refer to section 8.2.5.3 for more information.

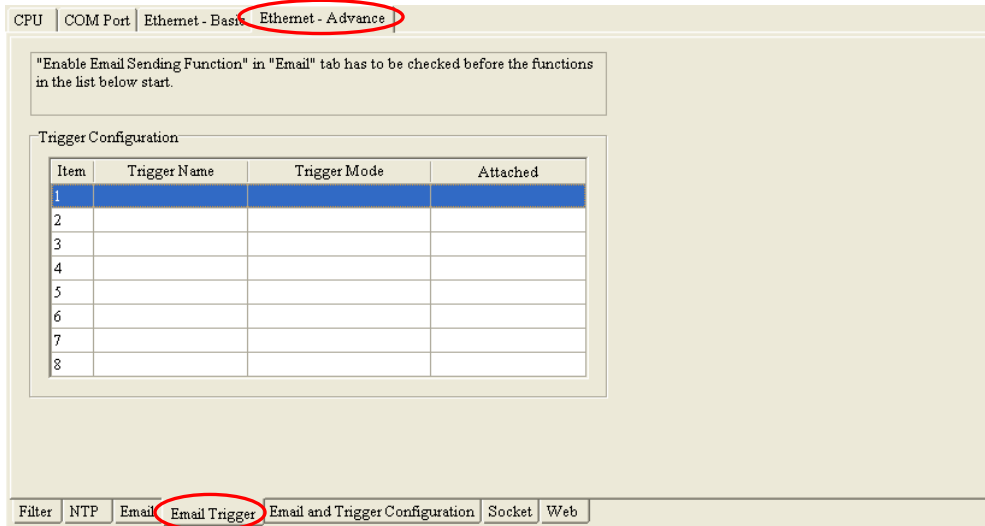

Triggers are listed in the **Trigger Configuration** table. Users can set eight triggers at most. If users want to set or view a trigger, they can double-click the trigger in the table. The **Trigger Configuration** window will appear.

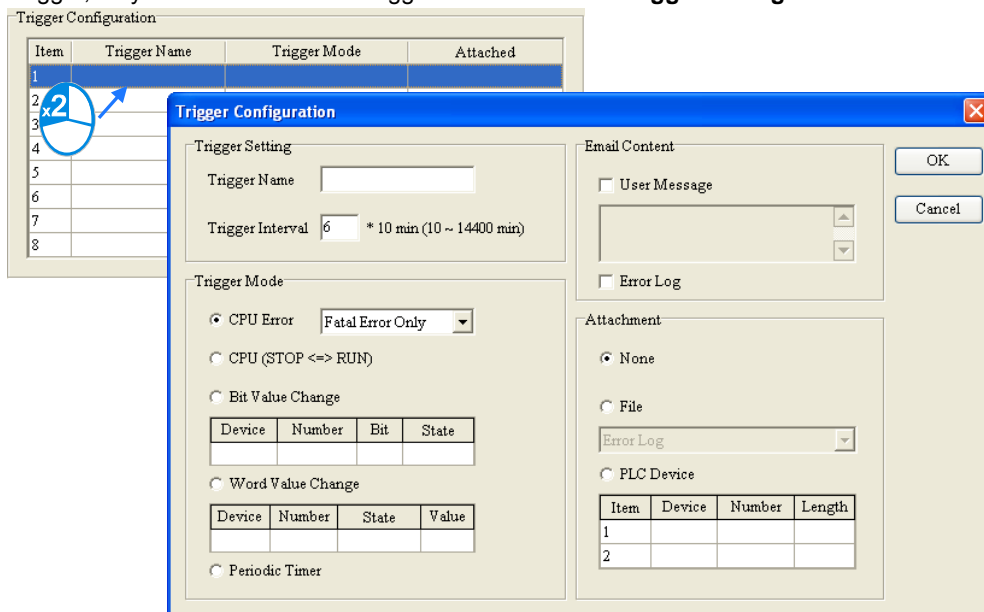

(1) Type a trigger name and an interval of triggering the sending of an email in the **Trigger Setting** section.

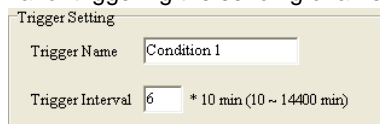

- **Trigger Name**
Users can type a trigger name in the **Trigger Name** box. Only English letters, numerical digits, or special marks can be typed in the box. A trigger name is composed of 16 characters at most. If the sending of an email is due to this trigger, the trigger name will be put in the subject of this email.
- **Trigger Interval**
Users can set an interval of triggering the sending an email. Ten minutes are taken as a unit. If the

condition of triggering the sending of an email is met, the system will send the email every specific period of time, and the email will not sent within the intervals.

- (2) Select a condition of triggering the sending of an email in the **Trigger Mode** section.

- **CPU Error**

If an error occurs in the CPU module, the condition of triggering the sending of an email is met. Please refer to operation manuals for more information about errors occurring in CPU modules. After users select the **CPU Error** option button, they have to select **Fatal Error Only** or **All Errors** in the drop-down list box at the right side of the option button.

(a) **Fatal Error Only:** If a fatal error occurs in the CPU module, the condition of triggering the sending of an email is met.

(b) **All Errors:** If an error occurs, the condition of triggering the sending of an email is met.

- **CPU (STOP<=>RUN)**

When the CPU module begins to run, or when the CPU module stops running, the condition of triggering the sending of an email is met.

- **Periodic Timer**

An email is sent periodically. How often an email is sent depends on the interval typed in the **Trigger Interval** box in the **Trigger Setting** section.

- **Bit Value Change**

If the state of a bit device specified meets a condition set, the sending of an email will be triggered. For example, if X0.0 is turned from OFF to ON, the condition of triggering the sending of an email will be met. If users want to set a condition, they can double-click the table under the option button to open the **Trigger Mode** window.

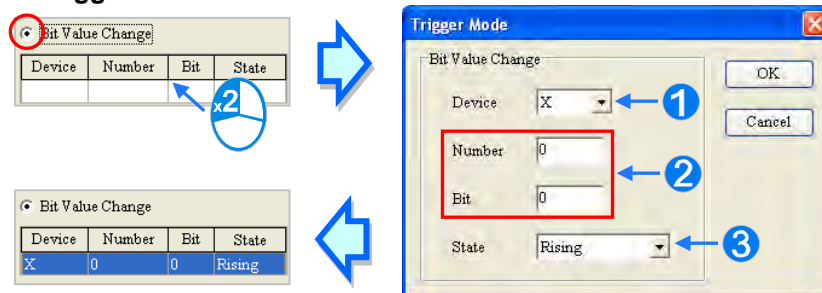

- ❶ **Device:** Users can select a device type in the **Device** drop-down list box.
- ❷ **Number & Bit:** Users can type a device address in the **Number** box. If the device type selected is X/Y/D/L, the users have to specify a bit number.
- ❸ **State:** Users can select **Rising** or **Falling** in the **State** drop-down list box.

- **Word Value Change**

If the value in a device specified meets a condition set, the sending of an email will be triggered. For example, if the value in D0 is larger than 10, the condition of triggering the sending of an email will be met. If users want to set a condition, they can double-click the table under the option button to open the **Trigger Mode** window.

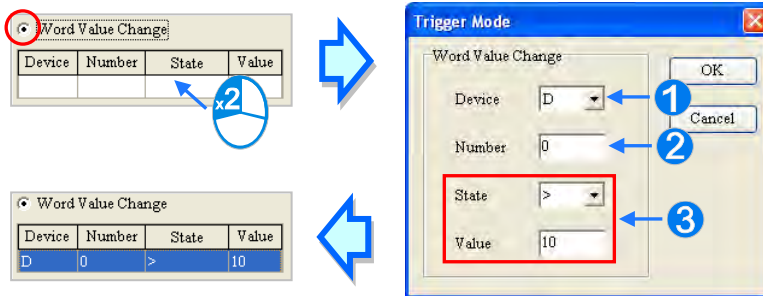

- ① **Device:** Users can select a device type in the **Device** drop-down list box.
- ② **Number:** Users can type a device address in the **Number** box.
- ③ **State & Value:** Users can set a condition of triggering the sending of an email here.

- (3) Select the **User Message** box or the **Error Log** box in the **Email Content** section. If a user-defined message is the text of an email, the **User Message** box is selected. If an error log in the CPU module is the text of an email, the **Error Log** box is selected. Only English letters, numerical digits, and special marks can be typed in the box under the **User Message** box.

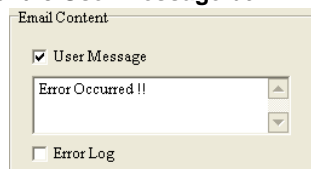

- (4) Select the **None** option button, the **File** option button, or the **PLC Device** option button in the **Attachment** section. If users want to set an attachment, they have to make sure of the maximum size of an email which the CPU module allows. Please refer to operation manuals for more information.

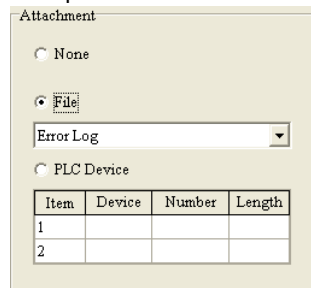

8

- **None**
If this option button is selected, no attachment will be inserted.
- **File**
Users can select an error log in the memory card, or the system backup file in the memory card as the attachment of the email.

● **PLC Device**

If this option button is selected, the system automatically retrieves the states of the devices, or the values in the devices listed in the table as the attachment when the email is sent. After this option button is selected, users can double-click the table to open the **Attachment** window. Two groups of devices at most can be set. For example, if the condition is met, the values in D0~D9 will be sent as an attachment.

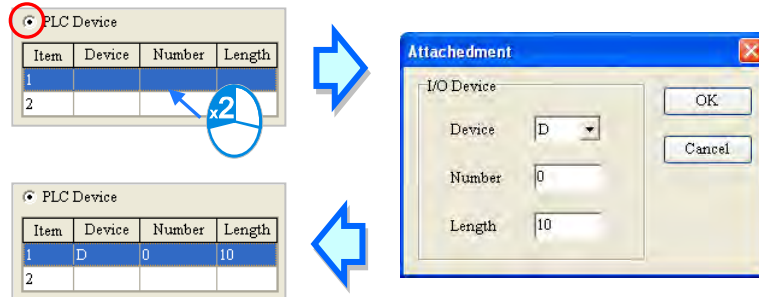

(5) After all the setting is complete, users can click **OK** to create the trigger.

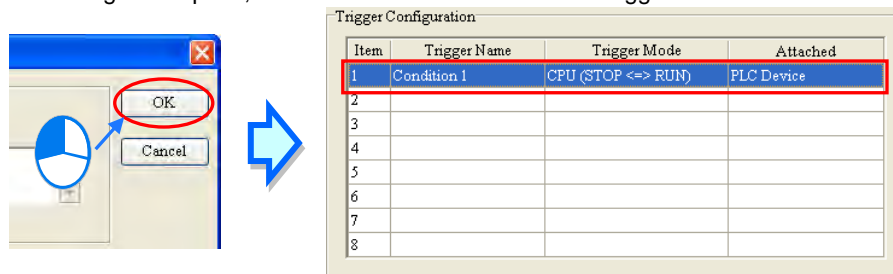

*. The parameters set in HWCONFIG must be downloaded to the CPU module so that they can take effect. (Please refer to section 8.2.6 or section 8.4.4 for more information.)

8.2.5.5 Ethernet—Advance: Email and Trigger Configuration

After users click the **Ethernet—Advance** tab at the top of the window, and the **Email and Trigger Configuration** tab at the bottom of the window, they can set the relation between triggers for the sending of emails and receivers. Before setting the function here, the users have to click the **Email** tab, select the **Enable Email Sending Function** checkbox, click the **Email Trigger** tab, and set at least one trigger. Please refer to section 8.2.5.3 and section 8.2.5.4 for more information.

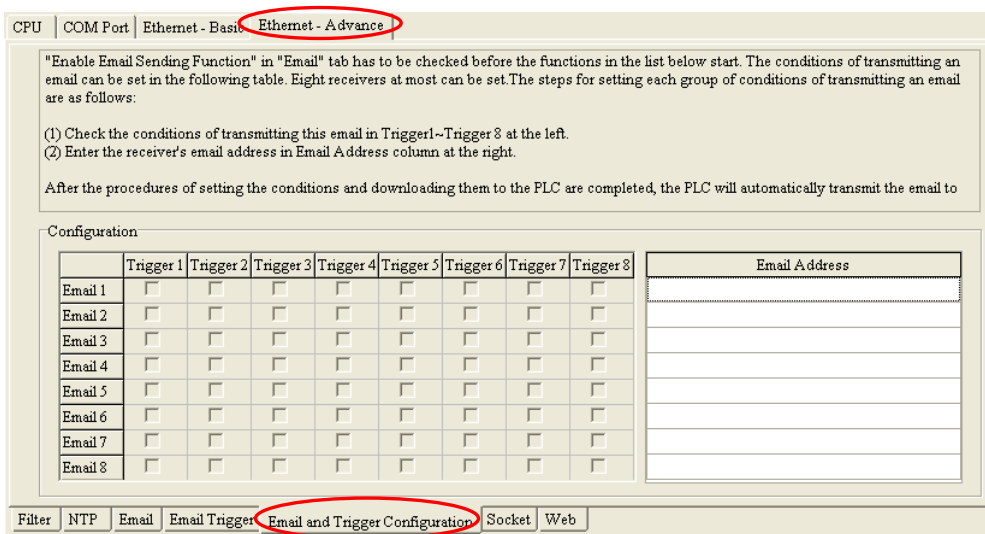

8

First, type the email addresses of receivers in the **Email Address** column. Eight email addresses at most can be set for the CPU module, and every email address is composed of sixty-four characters at most. Then, select triggers corresponding to receivers. If email addresses or triggers are not set, the corresponding selection

positions are gray.

For example, if the condition represented by trigger 1 or the condition represented by trigger 4 is met, the system will automatically send the emails to **user_1@delta.com.tw**. If the condition represented by trigger 2 or the condition represented by trigger 5 is met, the system will automatically send the email to **user_2@delta.com.tw**. If the condition represented by trigger 1 is met, the system will automatically send the email to **user_1@delta.com.tw**, and **user_4@delta.com.tw**.

Configuration									Email Address
	Trigger 1	Trigger 2	Trigger 3	Trigger 4	Trigger 5	Trigger 6	Trigger 7	Trigger 8	
Email 1	<input checked="" type="checkbox"/>	<input type="checkbox"/>	<input type="checkbox"/>	<input checked="" type="checkbox"/>	<input type="checkbox"/>	<input type="checkbox"/>	<input type="checkbox"/>	<input type="checkbox"/>	user_1@delta.com.tw
Email 2	<input type="checkbox"/>	<input checked="" type="checkbox"/>	<input type="checkbox"/>	<input type="checkbox"/>	<input checked="" type="checkbox"/>	<input type="checkbox"/>	<input type="checkbox"/>	<input type="checkbox"/>	user_2@delta.com.tw
Email 3	<input type="checkbox"/>	<input type="checkbox"/>	<input type="checkbox"/>	<input type="checkbox"/>	<input type="checkbox"/>	<input type="checkbox"/>	<input type="checkbox"/>	<input type="checkbox"/>	
Email 4	<input checked="" type="checkbox"/>	<input type="checkbox"/>	<input type="checkbox"/>	<input type="checkbox"/>	<input type="checkbox"/>	<input type="checkbox"/>	<input type="checkbox"/>	<input type="checkbox"/>	user_4@delta.com.tw
Email 5	<input type="checkbox"/>	<input type="checkbox"/>	<input type="checkbox"/>	<input type="checkbox"/>	<input type="checkbox"/>	<input type="checkbox"/>	<input type="checkbox"/>	<input type="checkbox"/>	
Email 6	<input type="checkbox"/>	<input type="checkbox"/>	<input type="checkbox"/>	<input type="checkbox"/>	<input type="checkbox"/>	<input type="checkbox"/>	<input type="checkbox"/>	<input type="checkbox"/>	
Email 7	<input type="checkbox"/>	<input type="checkbox"/>	<input type="checkbox"/>	<input type="checkbox"/>	<input type="checkbox"/>	<input type="checkbox"/>	<input type="checkbox"/>	<input type="checkbox"/>	
Email 8	<input type="checkbox"/>	<input type="checkbox"/>	<input type="checkbox"/>	<input type="checkbox"/>	<input type="checkbox"/>	<input type="checkbox"/>	<input type="checkbox"/>	<input type="checkbox"/>	

*. The parameters set in HWCONFIG must be downloaded to the CPU module so that they can take effect. (Please refer to section 8.2.6 or section 8.4.4 for more information.)

8.2.5.6 Ethernet–Advance: Socket

After users click the **Ethernet–Advance** tab at the top of the window, and the **Socket** tab at the bottom of the window, they can set the parameters for sockets through which data is transmitted. This function has to be used with specific applied instructions. Please refer to AH500 Programming Manual for more information. Sockets will not be introduced here. Please refer to related documents or manuals for more information about sockets.

The screenshot shows the 'Ethernet - Advance' configuration window. At the top, the 'Ethernet - Advance' tab is selected. Below it, there is a checkbox for 'Enable Socket Function'. Two tables are present: 'TCP Socket Connection' and 'UDF Socket Connection', both with columns for 'Item', 'Remote IP', 'Remote Port', and 'Length'. At the bottom, the 'Socket' tab is selected in the navigation bar.

An AH500 system supports the transmission of data between the CPU module and other CPU modules or devices by means of the creation of sockets, and supports TCP and UDP. Users can set eight TCP connections and eight UDP connections. If users want to set a TCP connection, they have to select the **Enable Socket Function** checkbox, and double-click an item in the **TCP Socket Connection** table to open the **TCP Socket Configuration** window. If the users want to set a UDP connection, they have to select the **Enable Socket Function** checkbox, and double-click an item in the **UDP Socket Connection** table to open the **UD Socket Configuration** window.

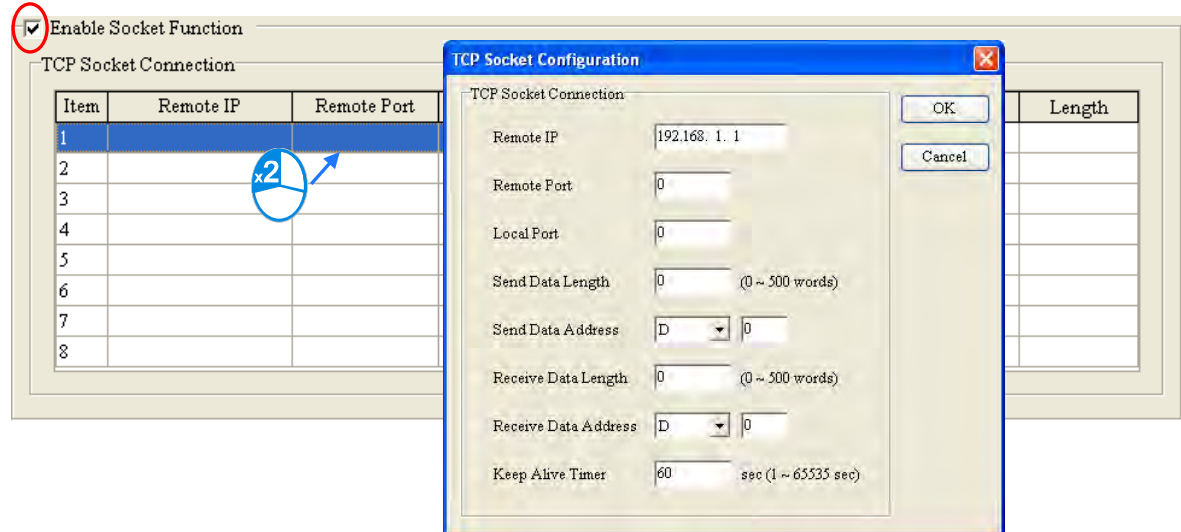

The parameters in the **TCP Socket Configuration** window are the same as the parameters in the **UDP Socket Configuration** window except that there is no **Keep Alive Timer** parameter in the UDP Socket Configuration window. The parameters in the **TCP Socket Configuration** window are described below.

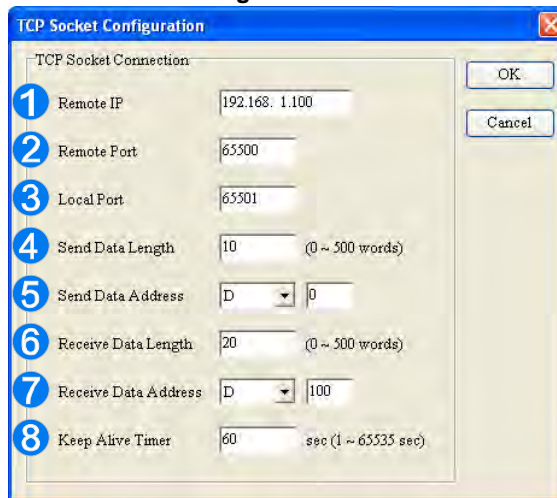

- ❶ Users can set a remote IP address.
- ❷ Users can set a communication port used by the remote device for this TCP connection. The port number must be in the range of 0 to 65535.
- ❸ Users can set a communication port used by the local CPU module for this connection. The port number must be in the range of 0 to 65535.
- ❹ Users can set the length of data which will be sent by the local CPU module. The length must be in the range of 0 words to 500 words.
- ❺ Users can set an initial device in the CPU module where data which will be sent is stored.
- ❻ Users can set the length of data which will be received by the local CPU module. The length must be in the range of 0 words to 500 words.
- ❼ Users can set an initial device in the CPU module where data which will be received is stored.
- ❽ Users can set a maximum keepalive time for the connection. If no data is transmitted, and the keepalive period has elapsed, the CPU module will terminate the connection automatically.

The port number used by the local CPU module and the port number used by the remote device can not be the same, and the devices where data which will be sent is stored can not overlap the devices where data which will be received is stored. If the IP address of the remote device is 192.168.1.100, the port number used by the remote device is 65500, and the port number used by the local CPU module is 65501, the remote device and the local CPU module can transmit data through this TCP connection.

If the local CPU module wants to send 10-word data to the remote device, the data will be stored in D0~D9 before the data is sent. If the local CPU module receives 20-word data from the remote device, the data will be stored in D100~D119.

If the length of data received is larger than the length set, the first 20-word data will be stored in D100~D119, and the data after the first 20-word data will be discarded. Likewise, if the length of data received is less than the length set, the data will be stored in the devices starting from D100, and the values in devices where no new data is stored will be retained.

If no data is transmitted, and 60 seconds have elapsed, the CPU module will close the socket, and terminate the connection.

*. The parameters set in HWCONFIG must be downloaded to the CPU module so that they can take effect. (Please refer to section 8.2.6 or section 8.4.4 for more information.)

8.2.5.7 Ethernet—Advance: Web

After users click the **Ethernet—Advance** tab at the top of the window, and the **Web** tab at the bottom of the window, they can enable the built-in web monitoring function of the CPU module.

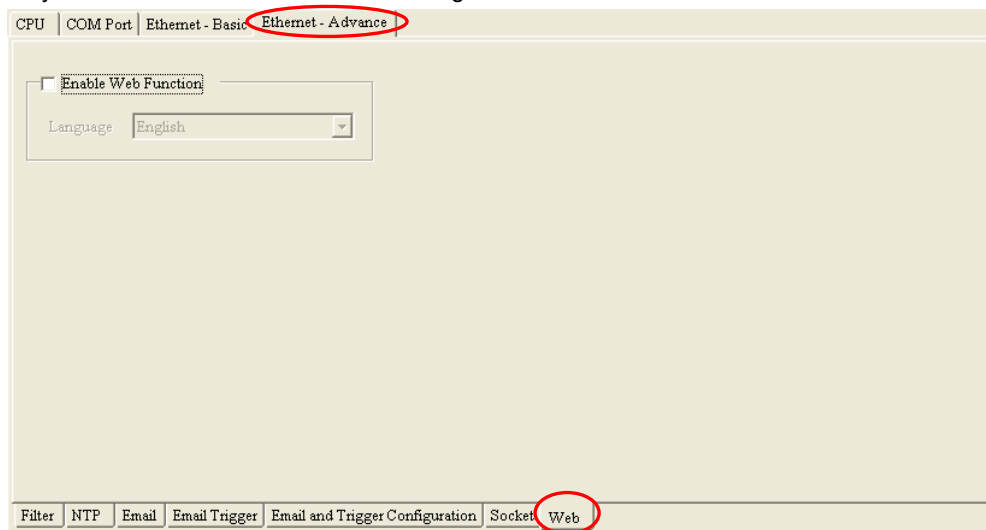

Select the **Enable Web Function** checkbox, and the select a language which will be adopted in the drop-down list box. After the parameter is downloaded to the CPU module correctly, users can view the built-in web pages in the CPU module by means of a web browser.

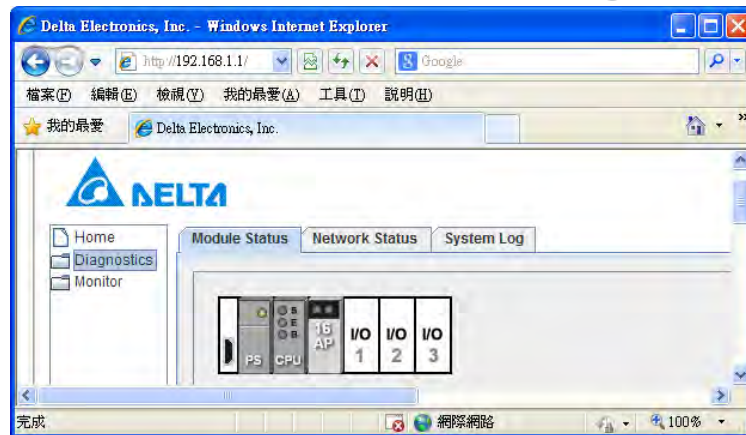
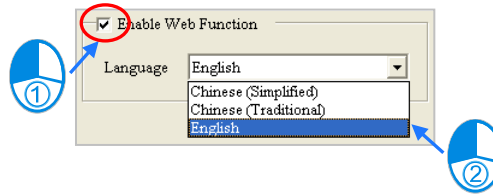

- *1. The parameters set in HWCONFIG must be downloaded to the CPU module so that they can take effect. (Please refer to section 8.2.6 or section 8.4.4 for more information.)
- *2. Please refer to operation manuals for more information about the web monitoring function.

8.2.6 Saving and Downloading/Uploading the PLC Parameters

After the setting of the PLC parameters is complete, users can click **OK** to apply the parameters. However, the parameters are still not saved as a file. If users want to save the parameters, they have to click **Save** on the **File** menu or  on the toolbar after the parameters are applied. After the saving of the parameters is complete, the parameters will be saved as a para file whose primary filename is the project name in the folder in which the project (*.isp) is saved.

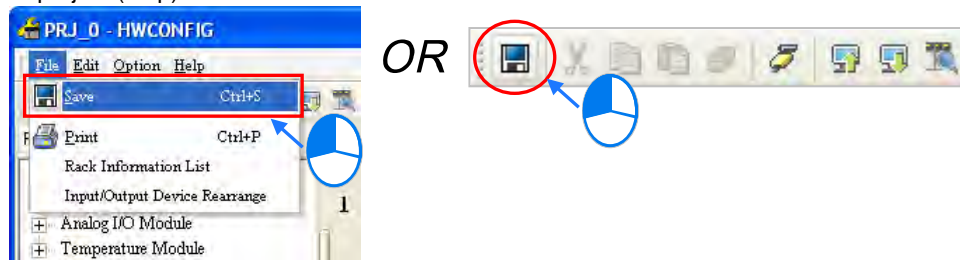



There are two ways to download or upload the PLC parameters. Users can download/upload the PLC parameters through the functions on the main screen of HWCONFIG. The hardware configuration and the parameters in the modules will also be downloaded/uploaded. Users can also download/upload the PLC parameters through the functions in the **PLC Parameter Setting** window. Only the PLC parameters will be downloaded/uploaded.

The downloading/uploading of the PLC parameters through the functions on the main screen of HWCONFIG will be introduced in section 8.4.4. The downloading/uploading of the PLC parameters through the functions in the **PLC Parameter Setting** window is introduced here.

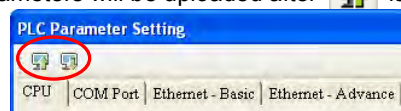
The PLC parameters will be downloaded after  in the upper left corner of the **PLC Parameter Setting** window is clicked, and the PLC parameters will be uploaded after  is clicked.



After  is clicked, all the PLC parameters will be uploaded. After  is clicked, the **Transfer Setup** window will appear. Users can select parameter types which will be downloaded in the window. Not all parameter types need to be downloaded to the CPU module.

The **Transfer Setup** window is shown below. If the **CPU** checkbox or the **Ethernet-Advance** are selected, the CPU module must stop running during the downloading of the parameters. As a result, if the CPU module does not stop running, a dialog box will appear before the parameters are downloaded.

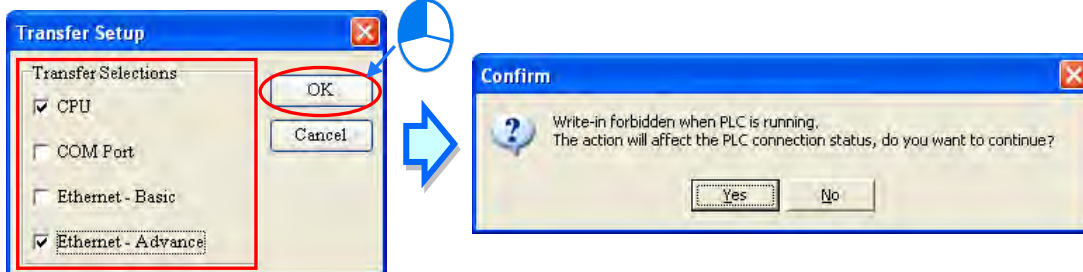

- *1. If the name of the CPU module is different from the name attached to the model in the project management area, a dialog box will appear before the parameters are downloaded or uploaded. Please refer to section 8.2.2.1 for more information.
- *2. HWCONFIG adopts the communication setting in ISPSOft. Please make sure that ISPSOft is connected to the CPU module normally before the parameters are downloaded/uploaded. Please refer to section 2.4 in ISPSOft User Manual for more information.

8.3 Setting the Parameters in an AH500 Series Module

8.3.1 Managing the Version of a Module

The functions of a module or the parameters in the module vary with the versions of the module. In HWCONFIG, the functions of the modules and the parameters in the modules are defined in a document called **MDS**. When ISPSOft is installed, the latest MDS document is also installed. If a new version of the MDS document is released, users can download it or get the related file from an agent.

An MDS document provides the information about the firmware versions of the modules. If users want to configure modules in HWCONFIG, they can select a suitable configuration according to the firmware versions of the actual modules. Besides, the parameters which can be set in the modules vary with the firmware versions of the modules which are set. If the firmware version of a module set in HWCONFIG is older than the firmware version of the actual module, the module will operate normally after the parameters are downloaded. If the firmware version of a module set in HWCONFIG is newer than the firmware version of the actual module, the module will not operate normally after the parameters are downloaded. Please refer to the descriptions in the table below for more information.

Difference	Compatibility
The firmware version set is older than the actual firmware version.	The module operates normally. Functions or parameters not defined in HWCONFIG are assigned the default values.
The firmware version set is newer than the actual firmware version.	The module can not operate, and is in an erroneous condition. Users have to select a firmware version which is the same as the firmware version of the actual module in HWCONFIG, check the parameters, and download the parameters again.

- *. The compatibility mechanism described above only applies to modules whose firmware version is 1.0 or above. A firmware version below 1.0 is not compatible with firmware version 1.0 or above.

If users want to set the firmware version of a module, they can select a version number in the **Firmware Version** drop-down list cell on the information list. If the firmware version of a module is unknown, no version number will be displayed.

Slot ...	Label	Firmware Version	Description	Input Device ...	Output Device ...	Comment
-	AHPS05-5A	-	AH Power Supply Module	None	None	
-	AHCPU530-EN	1.00	Basic CPU module building	None	None	
0	AH04AD-5A	1.00	4 x AI 16bit	D0 ~ D7		
1	AH04AD-5A	0.38	4 x AI	D8 ~ D15		
2		0.41				
3		1.00				

If users want to change the firmware versions of the modules of a certain model, they can click **Alter Overall Firmware Version** on the **Option** menu. The **Alter Overall Firmware Version** window will appear.

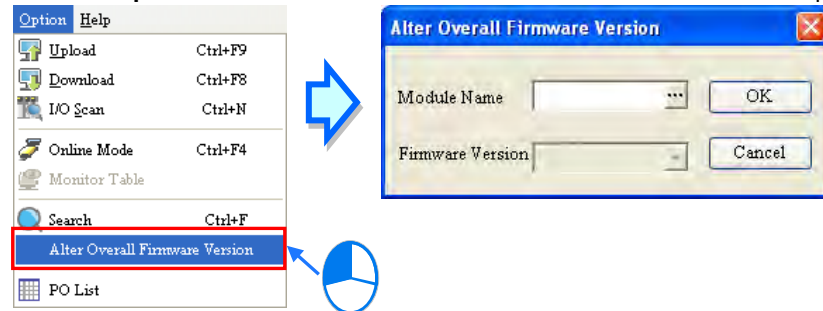

Click **...** in the **Module Name** box, select a module model in the **Module Selection** window, and double-click the module model.

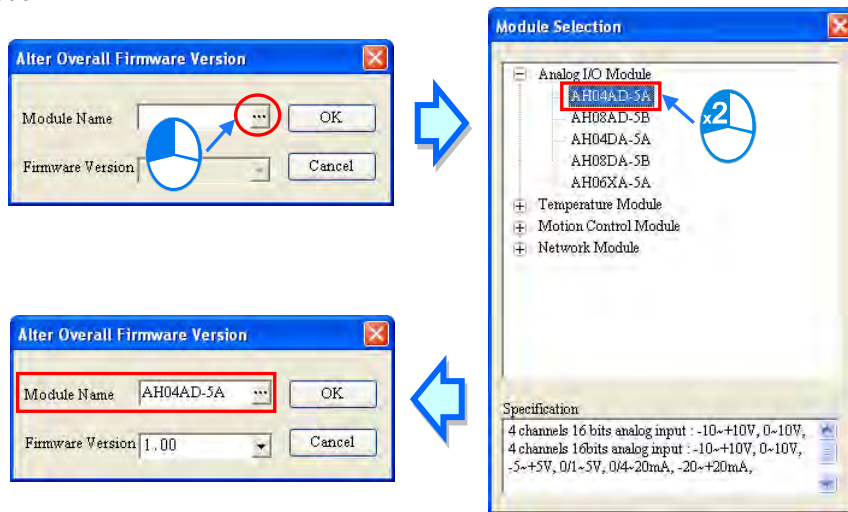

Select a version number in the **Firmware Version** drop-down list cell. After the setting is complete, users can click **OK** to change the firmware versions of the modules specified.

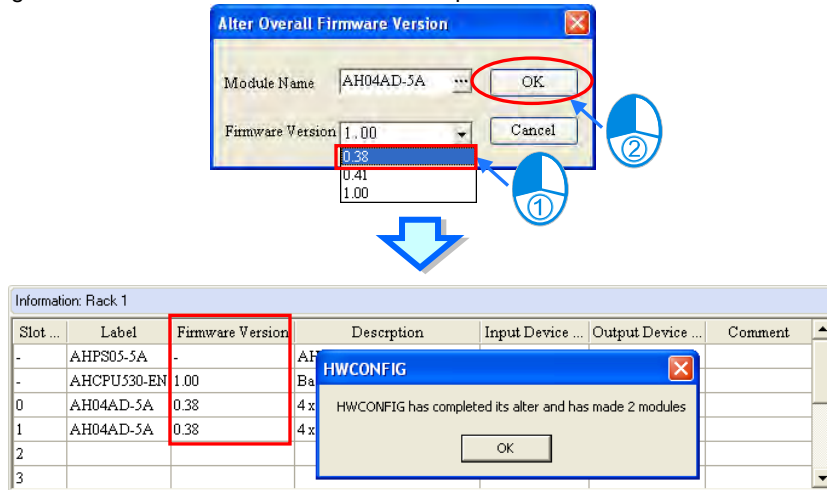

Additional remark

Users can know the firmware version of an actual module by clicking **I/O Scan** on the **Option** menu. If ISPSofT is connected to the CPU module, users can get the information about the firmware version of an actual module in the **Module Information** window. If users want to know the firmware version of an actual module by click **I/O Scan** on the **Option** menu, or view the information about the firmware version of an actual module in the **Module Information** window, ISPSofT must be connected to the CPU module normally, and the installation of modules must be completed. Please refer to section 8.4.5 and section 8.4.6 for more information.

8.3.2 Setting the Parameters in a Module

Users can set the parameters in every module configured in HWCONFIG. The functions and characters of every module depend on the setting of the parameters. If users want to set the parameters in a module, they can double-click the module in the system configuration area. The system will automatically open the **Parameter Setting** window.

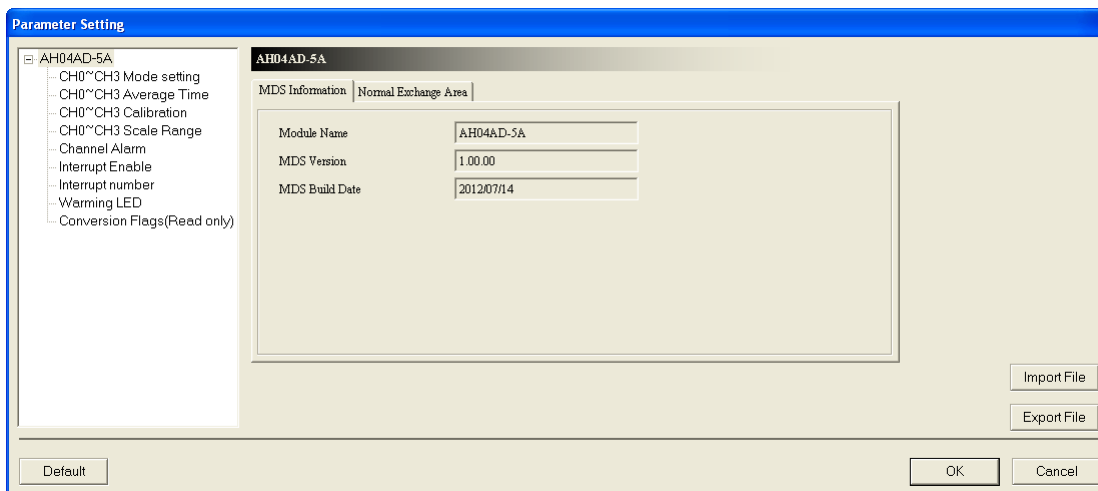

! The parameters are set according to the functions supported by the module. Before users set the parameters, they have to refer to AH500 Module Manual for more information. To prevent damage to the system or staff, the users have to make sure of the effect that the parameters which are set have on the module and the whole system.

There are two tabs in the window. They are the **MDS Information** tab and the **Normal Exchange Area** tab. If users click the **MDS Information** tab, the version of the MDS document will be displayed. The number of parameters which can be set in the module and the range of setting values depend on the version of the MDS document. Besides, if the parameters in HWCONFIG in a project are created by a newer MDS document, the system asks users to update the MDS document when the users open the **HWCONFIG** window in the project.



If users click the **Normal Exchange Area** tab, the functions to which the input/output devices assigned to the module correspond will be displayed.

Slot ...	Label	Firmware Version	Description	Input Device ...	Output Device ...	Comment
-	AHPS05-5A	-	AH Power Supply Module	None	None	
-	AHCPU530-EN	1.00	Basic CPU module building	None	None	
0	AH04AD-5A	1.00	4 x AI 16bit	D0 - D7		
1						

Description	Address
CH0 Input value	D0 - D1
CH1 Input value	D2 - D3
CH2 Input value	D4 - D5
CH3 Input value	D6 - D7

Users can select a parameter type at the left side of the window, and then set the parameters in the table at the right side of the window. The formats of the tables for the parameter types are the same, but the contents of the tables are different. Besides, the number of parameters which can be set and the range of setting values depend on the firmware version of the module which is set.

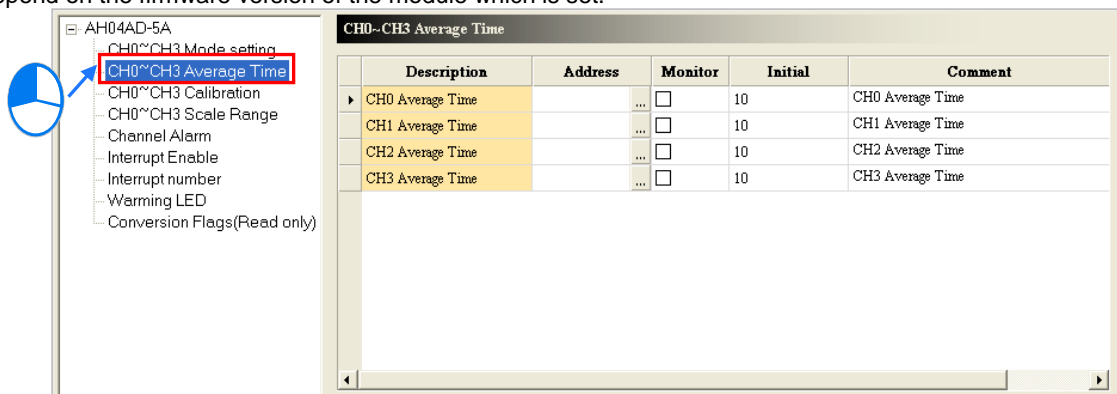

The description of the columns in a table is as follows. If the color of a table cell is gray, the cell can not be edited.

● **Description**

The parameter names or descriptions are shown in this column.

Description	Address	Monitor	Initial	Comment
CH0 Average Time	...	<input type="checkbox"/>	10	CH0 Average Time
CH1 Average Time	...	<input type="checkbox"/>	10	CH1 Average Time
CH2 Average Time	...	<input type="checkbox"/>	10	CH2 Average Time
CH3 Average Time	...	<input type="checkbox"/>	10	CH3 Average Time

● **Address**

Users can set data registers in this column. The parameters in the module which do not need to be updated constantly are stored in the data registers. If users specify data registers for the parameters in the module, and the parameters in HWCONFIG are downloaded to the CPU module correctly, the data registers in the CPU module are synchronized to the parameters in the module when the system operates. As a result, the users can access the module through the data registers. Accessing a module through the data registers is more efficient than accessing the module through the instruction FROM/TO. Besides, the number of data registers that a module has is limited. When users set data registers, they have to refer to the instructions for the module. While assigning the data registers, it is recommended to set it as latched. If it is not set as latched, the parameters on the module will be cleared when power-on and an unexpected error will occur.

As the example below shows, D3000 corresponds to the parameter **CH0 Average Time** in the **Parameter Setting** window for AH04AD-5A. After the parameters in HWCONFIG are downloaded to the CPU module, users can change the value of the parameter **CH0 Average Time** by changing the value in D3000 in the CPU module.

Besides, if users write a value which is not allowed by a parameter into a data register during the operation of the system, the system will restore the value in the data register and the value of the parameter to the original values.

*. Please refer to programming manuals for more information about the instruction FROM/TO.

If users want to set a data register, they can click ... in the **Address** cell for a parameter, and type a data register address which will be used in the **Address** window. Please notice that a data register address which has been assigned to the module can not be used. If users want to delete the data register address in the **Address** cell for a parameter, they can open the **Address** window in the same way, and delete the data register address in the window.



If the color of the **Address** cell for a parameter is gray, users can not set a data register for the parameter. In the example below, the values of these parameters are binary values. The states of certain bits in the data register set in the **Address** cell for the first parameter correspond to these parameters. Please refer to the documents for the modules for more information about the relation between parameters and the states of the bits in data registers.

	Description	Address	Monitor	Initial	Com
▶	Warn of CH0 Input value Out of Physical Range		<input type="checkbox"/>	<input type="checkbox"/> flashing	Warn of CH0 Input v
	Warn of CH1 Input value Out of Physical Range		<input type="checkbox"/>	<input type="checkbox"/> flashing	Warn of CH1 Input v
	Warn of CH2 Input value Out of Physical Range		<input type="checkbox"/>	<input type="checkbox"/> flashing	Warn of CH2 Input v
	Warn of CH3 Input value Out of Physical Range		<input type="checkbox"/>	<input type="checkbox"/> flashing	Warn of CH3 Input v

● **Monitor**

After users click **Monitor Table** on the **Option** menu in HWCONFIG, they can access a module through the data registers in the **Monitor Table** window. As a result, if a data register is set for a parameter in a module, and the checkbox in the **Monitor** cell for the parameter is selected, the data register specified will be displayed in the **Monitor Table** window after the **Monitor Table** window is opened. The checkbox in the **Monitor** cell for a parameter to which no data register is assigned can not be selected.

In the example below, D3000~D3003 are assigned to the parameters, but only D3000 and D3001 are monitored. As a result, only D3000 and D3001 will be displayed in the **Monitor Table** window after the **Monitor Table** window is opened. Please refer to section 8.4.6 for more information about **Monitor Table** in HWCONFIG.

	Description	Address	Monitor	Initial	Comment
	CH0 Average Time	D3000	<input checked="" type="checkbox"/>	20	CH0 Average Time
▶	CH1 Average Time	D3001	<input checked="" type="checkbox"/>	10	CH1 Average Time
	CH2 Average Time	D3002	<input type="checkbox"/>	10	CH2 Average Time
	CH3 Average Time	D3003	<input type="checkbox"/>	10	CH3 Average Time

● **Initial**

Users can set initial values in this column. When the parameters in HWCONFIG are downloaded, the initial values set are written into the module. Users may need to type initial values in the **Initial** columns for some of the parameter types, and select initial values in the **Initial** columns for the other parameter types. Please refer to the instructions for a module for more information about the range of values which can be set, and the processing mechanism after the downloading of the initial values.

	Description	Address	Monitor	Initial	Comment
	CH0 Average Time	D3000	<input checked="" type="checkbox"/>	20	CH0 Average Time
▶	CH1 Average Time	D3001	<input checked="" type="checkbox"/>	10	CH1 Average Time
	CH2 Average Time	D3002	<input type="checkbox"/>	10	CH2 Average Time
	CH3 Average Time	D3003	<input type="checkbox"/>	10	CH3 Average Time

● **Comment**

After users click the **Comment** cell for a parameter, they can type a comment on the parameter. A comment is composed of 32 characters at most, and a Chinese character occupies two characters. The default contents of the **Comment** column for a parameter type are usually the same as the contents of the **Description** column for the parameter type.

	Description	Address	Monitor	Initial	Comment
▶	CH0 Average Time	D3000	<input checked="" type="checkbox"/>	20	Comment...
	CH1 Average Time	D3001	<input checked="" type="checkbox"/>	10	CH1 Average Time
	CH2 Average Time	D3002	<input type="checkbox"/>	10	CH2 Average Time
	CH3 Average Time	D3003	<input type="checkbox"/>	10	CH3 Average Time

After **Default** in the lower left corner of the **Parameter Setting** window is clicked, the values of the parameters in the module will be restored to the default values.

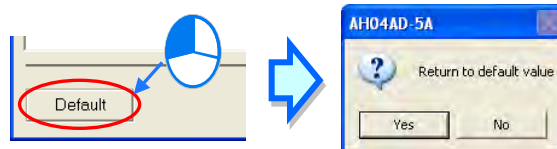

8.3.3 Exporting and Importing the Parameters in a Module

After **Export File** in the **Parameter Setting** window is clicked, the parameters in the module will be saved as a CSV file. A file which was exported previously can also be imported.

- **Exporting the parameters in a module**

Click **Export File** in the **Parameter Setting** window, select a folder in the **Save in** drop-down list box in the **Save As** window, type a filename in the **File name** box, and click **Save**.

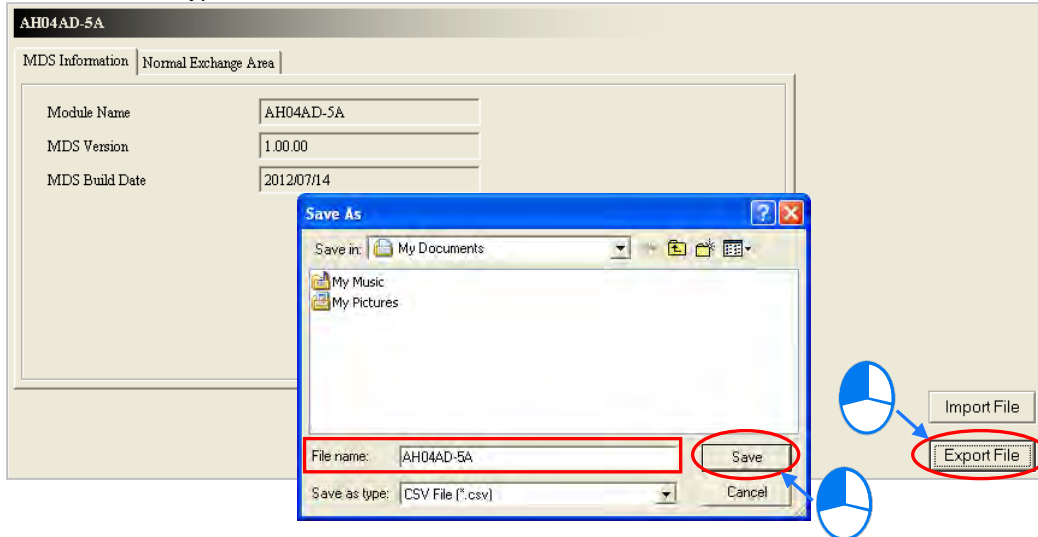

- **Importing the parameters in a module**

Click **Import File** in the **Parameter Setting** window, select a file which will be imported in the **Save As** window, and click **Open**.

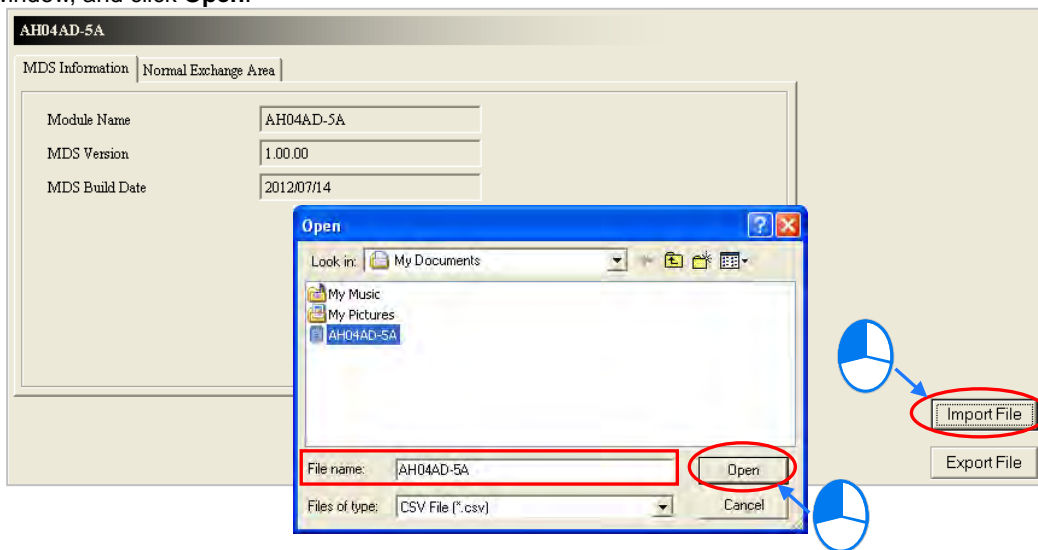

Before the parameters are imported, the system will check the file format and the module model. If the file format or the module model is not correct, the system will forbid the import of the parameters. If the data registers specified in the original file exported have been used in the present configuration, different data registers will be specified in the file after the file is imported.

8.3.4 Setting the Parameters in an Intelligent Module

Delta Electronics, Inc. provides the exclusive configuration tools for some modules. Through the software, the modules can be configured further, and the parameters in the modules can be set further. Some of the configuration tools can be opened through HWCONFIG. The configuration tools supported by HWCONFIG are listed in the table below. The table suggests that the configuration tools for modules which are not listed in the table can not be opened through HWCONFIG. It does not suggest that there are no configuration tools for modules which are not listed in the table.

Module type	Module model	Software supported and its version
Network module	AH10EN-5A	The configuration tool is in HWCONFIG, and does not need to be installed.
	AH10SCM-5A	DCISoft version 1.08 or above needs to be installed.

- *1. DCISoft version 1.08 or above can be opened through HWCONFIG. Users can select a version of DCISoft according to the specifications for AH10SCM-5A and their requirements.
- *2. The configuration tool for AH10SCM-5A is SCMSoft. After DCISoft version 1.08 or above is installed, SCMSoft can be used.

If users want to set the parameters in an intelligent module, they can right-click the module in the system configuration area, and click **Intelligent Module Configuration** on the context menu. If the configuration and the setting of the parameters in HWCONFIG have not been saved, the system will ask the users to save the configuration and the setting before the corresponding software is started. If the corresponding software is started, the users can not perform any editing tasks in HWCONFIG before the software is closed. Please refer to instructions for software and modules for more information about the usage of the software.

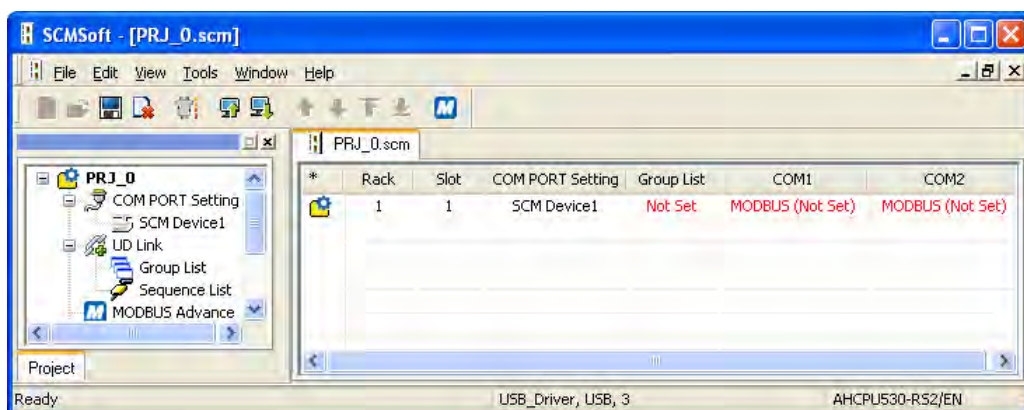
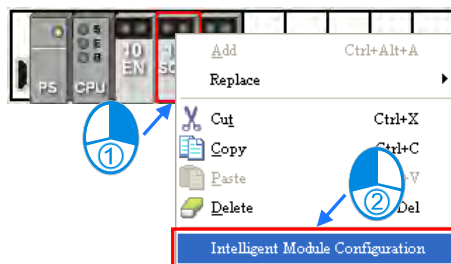

8.4 Management of the Parameters in AH500 Series Hardware and Online Diagnosis

8.4.1 Saving and Printing a Hardware Configuration

After a hardware configuration is complete, the setting in HWCONFIG can be saved with the whole project. The contents which are saved include the hardware configuration, the parameters in the modules, and the parameters in the CPU module, but do not include the parameters in the intelligent modules. The parameters in the CPU module are saved as a para file whose primary filename is the project name. The hardware configuration and the parameters in the modules are saved as an hw file whose primary filename is the project name. The files are saved in a folder in which the project (*.isp) is saved.

If users want to save the setting in HWCONFIG, they can click **Save** on the **File** menu, or  on the toolbar.

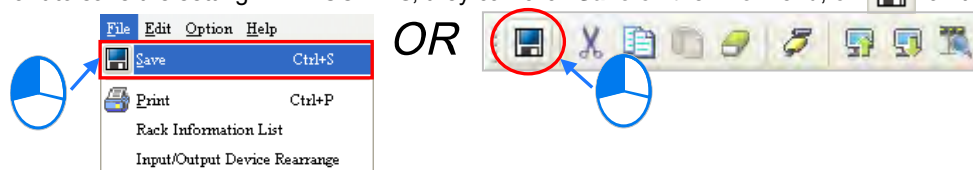

If users want to perform a printing task, they click **Print** on the **File** menu to open the **Print Preview** window. The contents which are printed only include the configuration in the configuration area. Please refer to appendix C for more information about the **Print Preview** window.

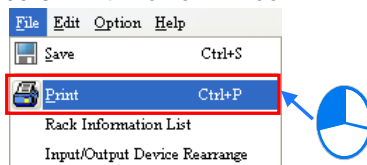

Additional remark

If the CPU module is changed in ISPSOft after the setting of the parameters in the hardware is complete, and the new CPU module can not completely support the range of devices set for the original hardware, a warning message appears when the **HWCONFIG** window is opened again.

The problematic modules are marked with triangular error signs in HWCONFIG. These modules are in an abnormal condition. The **Download** function and the **Online Mode** function can not be enabled. After the incorrect device addresses are modified, users can proceed with the operation. Besides, the triangular error signs will disappear after the incorrect devices addresses are modified.

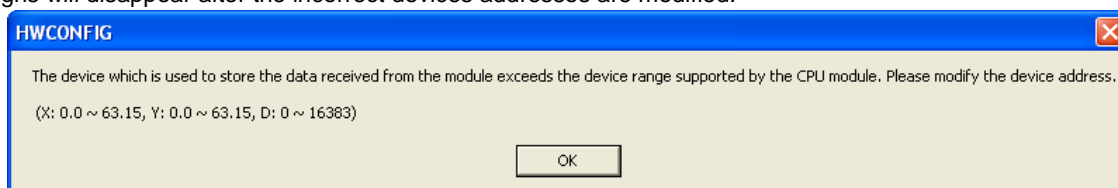

8

8.4.2 Purchase Order

After a hardware configuration is complete, users can click **PO List** on the **Option** menu. The system will collect the hardware which are configured, and list it in a list.

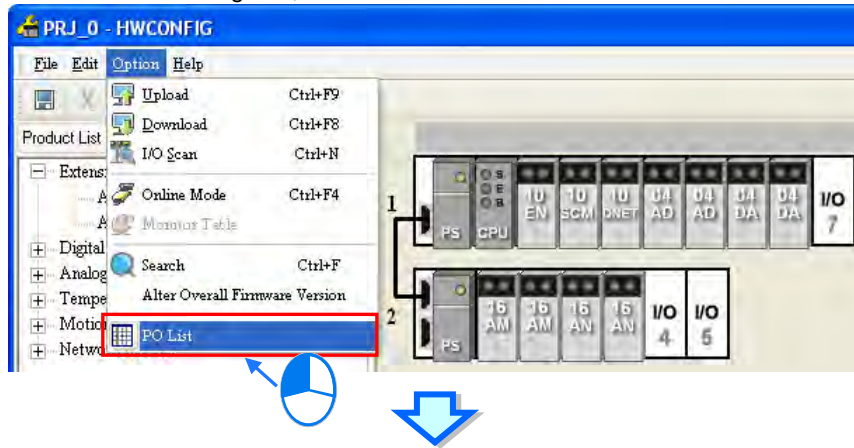

Product Name	Description	Count
AHBP08M1-5A	8 I/O slots main backplane	1
AHBP06E1-5A	6 I/O slots extension backplane	1
AHPS05-5A	AH Power Supply Module	2
AHCPU530-EN	Basic CPU module building with Ethernet, RS485, USB	1
AH10EN-5A	Ethernet master module	1
AH10SCM-5A	Serial communication module	1
AH10DNET-5A	DeviceNet scanner	1
AH04AD-5A	4 x AI 16bit	2
AH04DA-5A	4 x AO 16bit	2
AH16AM10N-5A	16 x DI, 24 VDC	2
AH16AN01R-5A	16 x DO, Relay 240 VAC/24 VDC	2
Extension Communication Cable	I/O Extension Cable	1

After **Export** on the **File** menu in the upper left corner of the window is clicked, the list will be saved as a CSV file. The data which is exported can be edited or managed through Microsoft Excel.

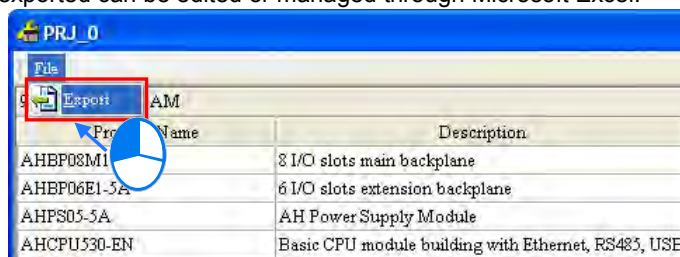

8.4.3 Rack Information List

After a hardware configuration is complete, users can click **Rack Information List** on the **File** menu. The users can view the configuration in the **Rack Information List** window. The modules in the window are sorted according to the backplanes on which they are installed, and arranged in a hierarchical tree structure. The users can fold or unfold a rack section to increase the convenience of viewing the configuration.

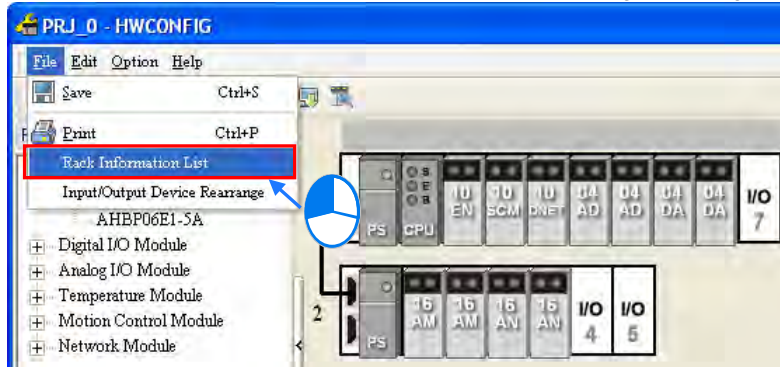

Slot No.	Name	Description	Input Device Range	Output Device Range	Comment
Information: Rack 1					
-	AHPS05-5A	AH Power Supply Module	None	None	
-	AHCPU530-EN	Basic CPU module building with	None	None	
0	AH10EN-5A	Ethernet master module	D0 ~ D19	D20 ~ D39	
1	AH10SCM-5A	Serial communication module	D40 ~ D57		
2	AH10DNET-5A	DeviceNet scanner	None	None	
3	AH04AD-5A	4 x AI 16bit	D58 ~ D65		
4	AH04AD-5A	4 x AI 16bit	D66 ~ D73		
5	AH04DA-5A	4 x AO 16bit		D74 ~ D81	
6	AH04DA-5A	4 x AO 16bit		D82 ~ D89	
7					
Information: Rack 2					
-	AHPS05-5A	AH Power Supply Module	None	None	
0	AH16AM10N-5	16 x DI, 24 VDC	X0.0 ~ X0.15		
1	AH16AM10N-5	16 x DI, 24 VDC	X1.0 ~ X1.15		
2	AH16AN01R-5	16 x DO, Relay 240 VAC/24 VDC		Y0.0 ~ Y0.15	
3	AH16AN01R-5	16 x DO, Relay 240 VAC/24 VDC		Y1.0 ~ Y1.15	
4					
5					

After **Export** on the **File** menu in the upper left corner of the window is clicked, the list will be saved as a CSV file. The data which is exported can be edited or managed through Microsoft Excel.

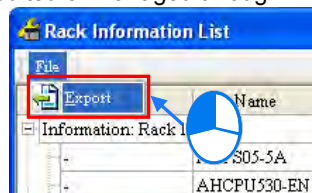

8.4.4 Downloading/Uploading the System Parameters

The parameters set in HWCONFIG must be downloaded to the CPU module so that they can take effect. Owing to the fact that HWCONFIG adopts the communication setting in ISPSOft, users have to make sure that ISPSOft is connected to the CPU module normally before the parameters are downloaded/uploaded. Please refer to section 2.4 in ISPSOft User Manual for more information about communication setting. If users want to download/upload the program, but the name of the CPU module is different from the name attached to the model in the project management area, the system will remind the users to check the name of the CPU module and the name attached to the model in the project management area. Please refer to section 8.2.2.1 for more information.

- **Downloading the system parameters**

After users click **Download** on the **Option** menu, or  on the toolbar, the **Transfer Items** window will appear. The items which will be downloaded include the hardware configuration, the parameters in the modules, and the parameters in the CPU module, but do not include the parameters in the intelligent modules. After the users click **OK**, the parameters will be downloaded to the CPU module.

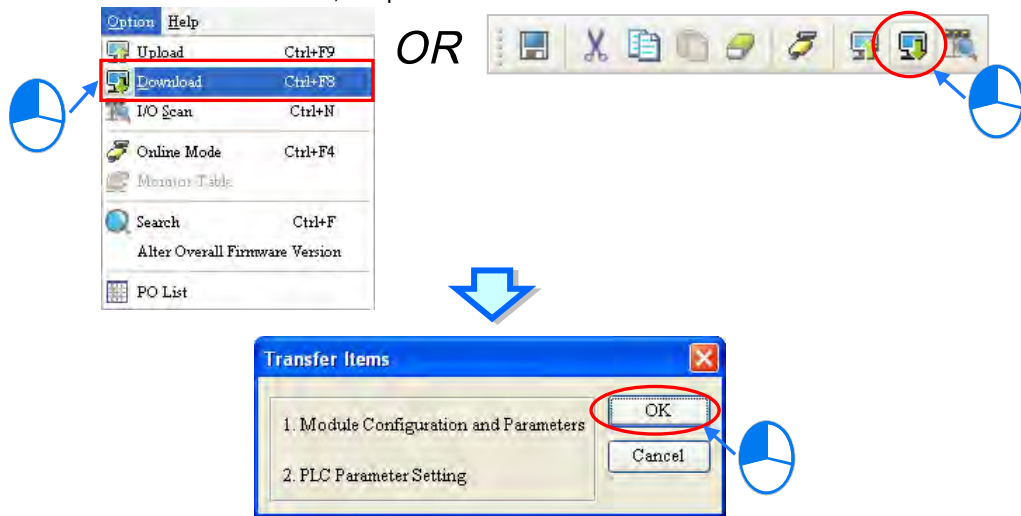

- **Uploading the system parameters**

After users click **Upload** on the **Option** menu, or  on the toolbar, the system parameters in the CPU module will be uploaded to HWCONFIG. The items which will be uploaded include the hardware configuration, the parameters in the modules, and the parameters in the CPU module, but do not include the parameters in the intelligent modules.

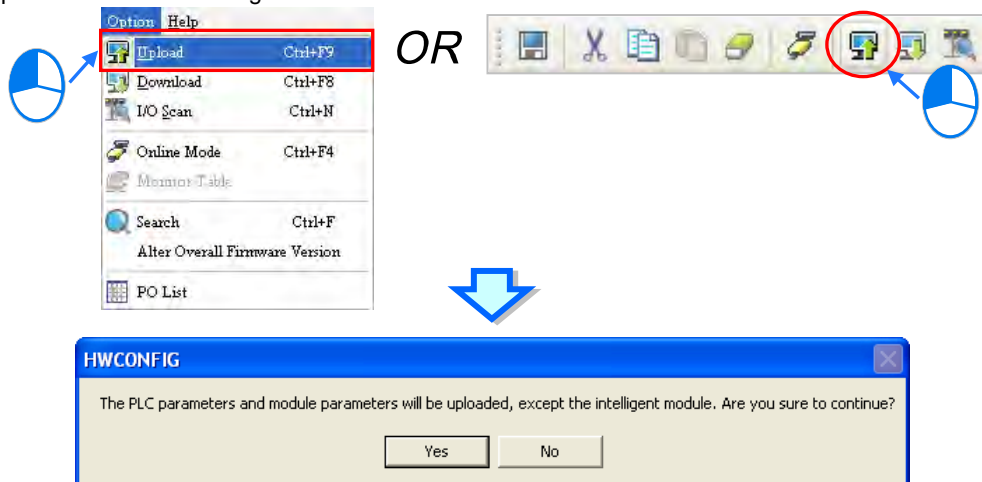

8.4.5 I/O Scan

Users can configure modules in the way mentioned above. If users have gotten related hardware, they can install the hardware, click **I/O Scan** in HWCONFIG, and scan the actual hardware configuration through communication. The time of configuring the modules will be saved. Users have to make sure that ISPSOft has connected to the CPU module normally before they carry out the operation. Please refer to section 2.4 in ISPSOft User Manual for more information about communication setting.

Users can click **I/O Scan** on the **Option** menu, or  on the toolbar to carry out the operation. The contents which will be scanned include the module models, the hardware configuration, and the firmware versions of the modules, but do not include the parameters in the modules and the parameters in the CPU module. After **I/O Scan** is clicked, the original hardware configuration and the parameter setting will be cleared. However, the parameters in the CPU module will not be affected.

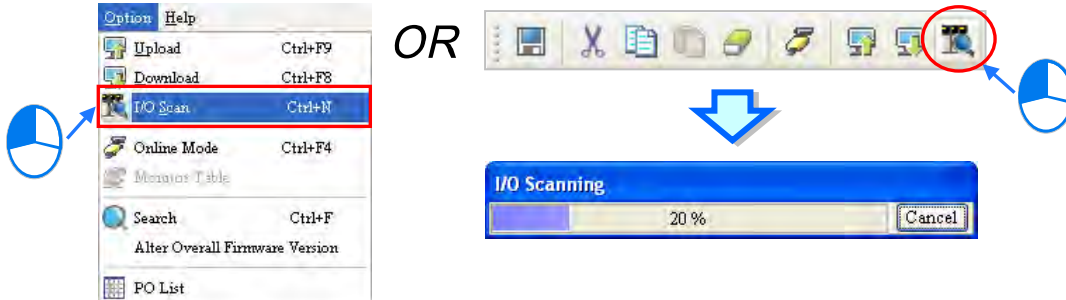

After the scan is complete, the actual hardware configuration will be displayed in the system configuration area, the system will assign input/output devices to the modules, the parameters in the modules are assigned the default values, and the firmware versions set in HWCONFIG will be the actual firmware versions of the modules. If the firmware version of a module which is scanned is higher than the firmware version of the module in the MDS document, the highest version which can be selected will be displayed in the **Firmware Version** drop-down list cell for the module, and the actual firmware version of the module will be displayed in the **Comment** cell for the module.

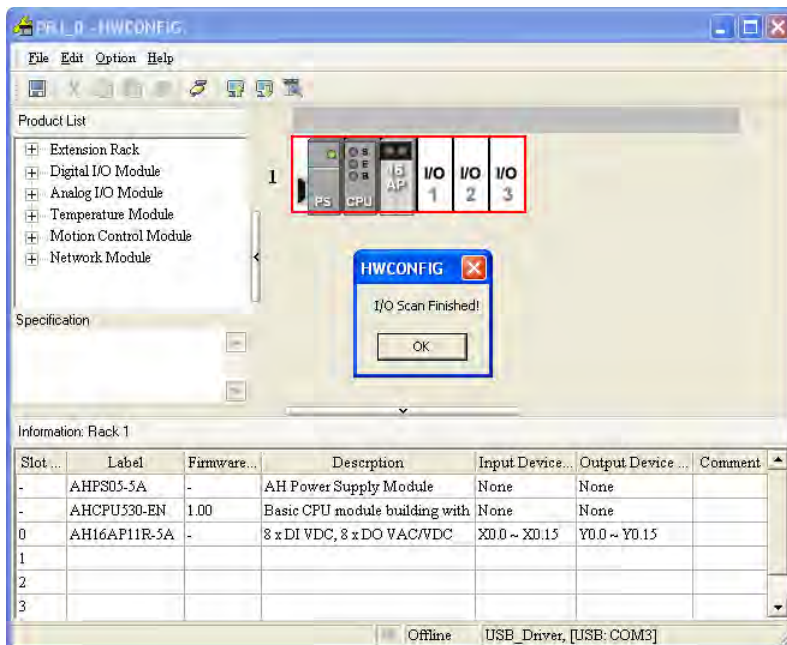

*. Please refer to section 8.3.1 for more information about MDS documents and firmware versions of modules. The difference between **I/O Scan** and **Upload** can be illustrated with the following example. If **I/O Scan** is clicked, the hardware configuration will be scanned, and the parameters in the modules will not be scanned. If **Upload** is clicked, the hardware configuration in the CPU module will be read. The hardware configuration uploaded to HWCONFIG may be different from the actual hardware configuration.

The parameters in the hardware shown below are downloaded to the CPU module first. The parameter in AH16AN01R-5A (installed in slot 1) is as follows.



Output setting				
Description	Address	Monitor	Initial	Comment
Keep last value when stop		<input type="checkbox"/>	<input checked="" type="checkbox"/> Enable	Keep last value when stop

Then, AH04HC-5A installed in slot 2 is removed from the actual backplane. The BUS FAULT LED indicator on the CPU module will be ON, that is to say, the hardware configuration in the CPU is different from the actual hardware configuration.

Next, **I/O Scan** is clicked. The scan result will be the same as the actual hardware configuration. After AH16AN01R-5A (installed in slot 1) is double-clicked to open the **Parameter Setting** window, users will find that the parameter in the module is assigned the default value. The value of the parameter is different from the value of the parameter previously downloaded to the CPU module, that is to say, only the hardware configuration will be scanned after **I/O Scan** is clicked.

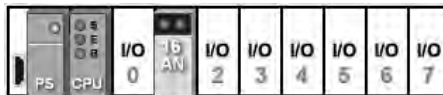

Output setting				
Description	Address	Monitor	Initial	Comment
Keep last value when stop		<input type="checkbox"/>	<input type="checkbox"/> Enable	Keep last value when stop

Then, **Upload** is clicked. After the uploading is complete, users will find that the hardware configuration and the parameters in the modules which are uploaded are the same as the hardware configuration and the parameters in the modules which were previously downloaded to the CPU module. In other words, after **Upload** is clicked, the system parameters in the CPU module will read, and the actual hardware configuration will not be uploaded.



Output setting				
Description	Address	Monitor	Initial	Comment
Keep last value when stop		<input type="checkbox"/>	<input checked="" type="checkbox"/> Enable	Keep last value when stop



Next, **I/O Scan** is clicked, and the scan result is downloaded to the CPU module. The BUS FAULT LED indicator on the CPU module will be OFF, that is to say, the hardware configuration in the CPU module is the same as the actual hardware configuration.



8.4.6 Online Diagnosis

Users not only can configure modules in HWCONFIG offline, but also can operate and inspect the system through the **Online Mode** function if ISPSOFT is connected to the CPU module. Owing to the fact that HWCONFIG adopts the communication setting in ISPSOFT, users have to make sure that ISPSOFT is connected to the CPU module normally before the **Online Mode** function is enabled. Please refer to section 2.4 in ISPSOFT User Manual for more information about communication setting. If users want to enable the **Online Mode** function, but the name of the CPU module is different from the name attached to the model in the project management area, the system will remind the users to check the name of the CPU module and the name attached to the model in the project management area. Please refer to section 8.2.2.1 for more information.

8.4.6.1 Online Mode

- (1) After users click **Online Mode** on the **Option** menu, or  on the toolbar, the hardware configuration will be in the online mode. If the users click  again, the hardware configuration will not be in the online mode.

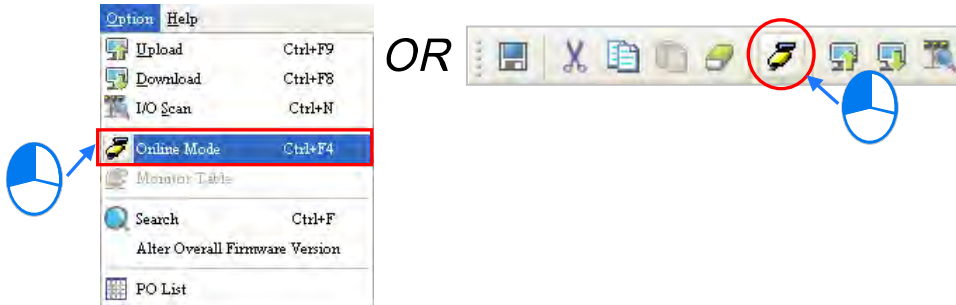

- (2) Before the hardware configuration enters the online mode, the system checks whether the hardware configuration stored in the CPU module is the same as the hardware configuration in the system configuration area. If the hardware configuration stored in the CPU module is different from the hardware configuration in the system configuration area, the system will ask users to download the hardware configuration again.

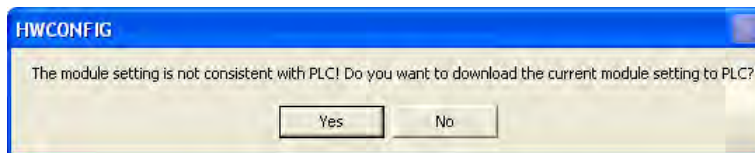

- (3) After the hardware configuration enters the online mode, the statuses of the modules displayed in the system configuration area will vary with the actual statuses of the modules. The statuses of the LED indicators on the CPU module displayed in the system configuration area are the same as the actual statuses of the LED indicators on the CPU module. The LED indicators are the RUN LED indicator, the ERROR LED indicator, and the BUS FAULT LED indicator from top to bottom.

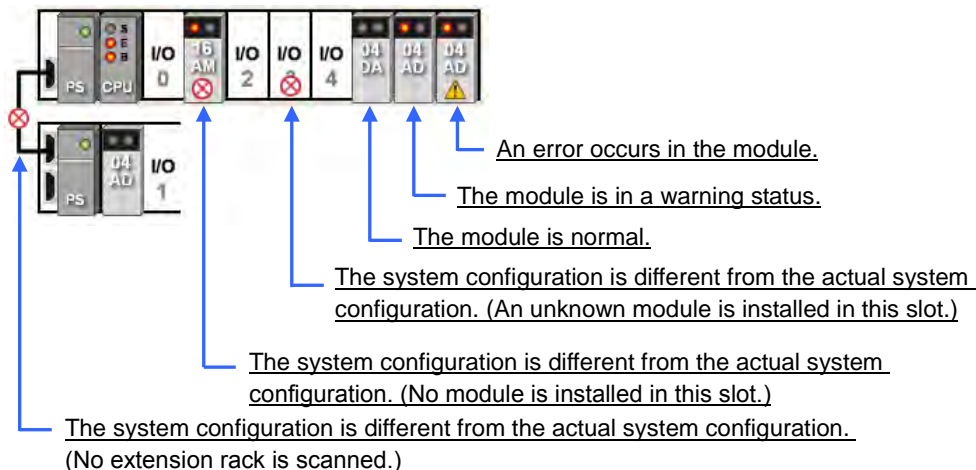

8

8.4.6.2 Module Information and Diagnosis

If the hardware configuration is in the online mode, users can right-click the CPU module or a module, and click **Module Information** on the context menu. The users can get the information related to the CPU module or the module through the connection, and the information is displayed in the **Module Information** window.

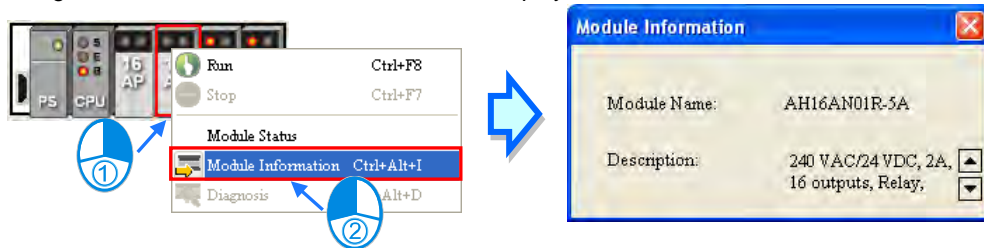

If users right-click a module, and click **Diagnosis** on the context menu, the **Module Error Log** window will appear.

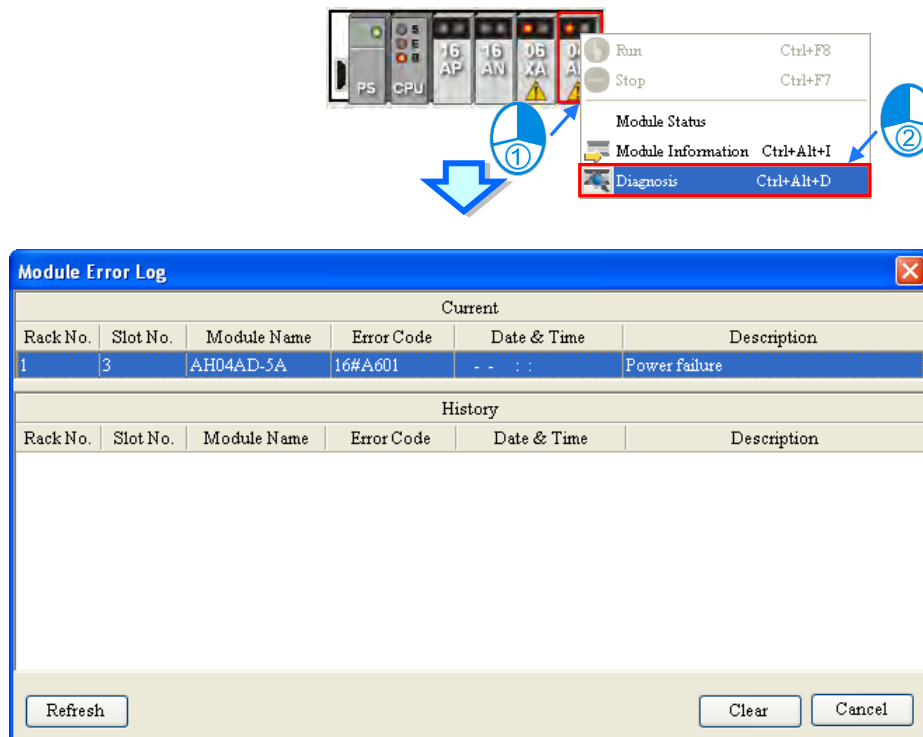

In the **Module Error Log** window, the current error is displayed in the **Current** column, and the errors which occurred before are displayed in the **History** column. The numbers of error logs which are stored in the modules are different. If the errors which occurred in a module before are not stored in the module, the **History** column will be blank. Besides, owing to the fact that the digital I/O modules do not generate any error code, users can not use the **Diagnosis** function.

After the errors occurring in a module are eliminated, users can click **Clear** to clear the errors in the window, and the error stored in the module. The module will not be in the erroneous condition. After users click **Refresh**, the system will retrieve the data in the module again. The data will be displayed in the window.



8.4.6.3 Changing the Status of a Module Online

If the hardware configuration is in the online mode, users can change the status of a module, carry out a simple test.

⚠ Before the status of a module is changed, users have to make sure that the operation does not cause damage to the system or staff.

- **Changing the operating state of a module**

If the hardware configuration is in the online mode, users can right-click a module, and click **Run** on the context menu. The module will begin to run. When the module runs, the green light on the module is ON. If the users click **Stop** on the context menu, the module will stop running. Besides, if the operating state of the CPU module is changed, the operating states of all the modules are also changed.

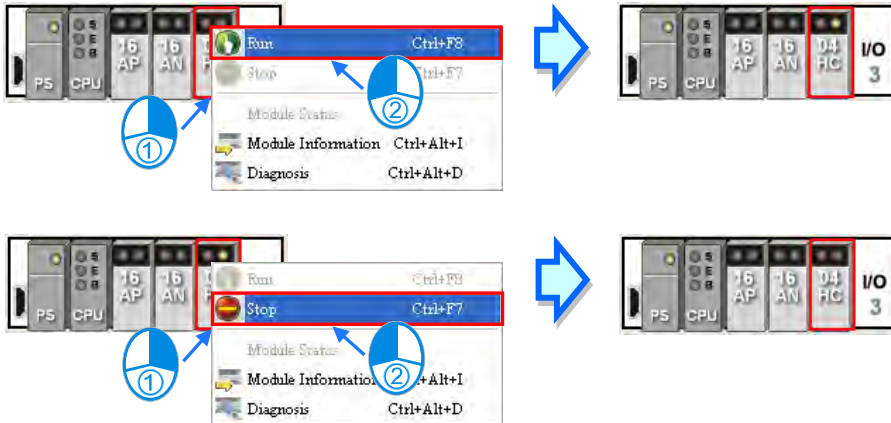

- **Changing the input/output state of a module**

If the modules which are configured include a digital I/O module, an analog I/O module, or a temperature measurement module, users can right-click the module, and click **Module Status** on the context menu. The users can monitor the input/output state of the module in the window which appears. In the window for a digital I/O module, users can right-click an input/output channel, and click **Force ON** or **Force OFF** on the context menu. Before **Force ON** or **Force OFF** on the context menus is clicked, the CPU module and the digital I/O module must run to produce the actual outputs.

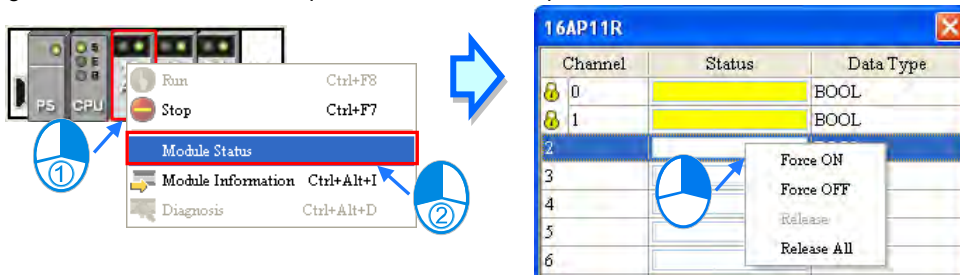

- **Force ON:** The channel selected is forced ON.
- **Force OFF:** The channel selected is forced OFF.
- **Release:** The channel selected is not forced ON/OFF.
- **Release all:** All the channels are not forced ON/OFF.

● **Changing the values of the parameters in a module**

If a module is assigned data registers, users can change the values in the data registers after the hardware configuration enters the online mode. However, on account of the design of the module, the CPU module and the module may need to run to produce the values of the parameters before the values in the data registers are changed.

- (1) If the hardware configuration is in the online mode, users can double-click a module to open the **Parameter Setting** window, and click a parameter type which will be set at the left side of the window. The users will find that the appearance of the table in the window is quite different from the appearance of the table in the offline mode.

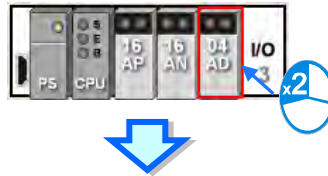

Parameter Setting

AH04AD-5A

- CH0~CH3 Mode setting
- CH0~CH3 Average Time**
- CH0~CH3 Calibration
- CH0~CH3 Scale Range
- Channel Alarm
- Interrupt Enable
- Interrupt number
- Warning LED

Description	Address	PV	SV	Comment
CH0 Average Time	D3000	10	10	CH0 Average Time
CH1 Average Time	D3001	10	10	CH1 Average Time
CH2 Average Time		10	10	CH2 Average Time
CH3 Average Time		10	10	CH3 Average Time

- (2) The present values of the parameters are displayed in the **PV** column, but they are not updated timely. After users click in the window, the system will retrieve the present values again, and the values retrieved will be displayed in the **PV** column.

Description	Address	PV	SV	Comment
CH0 Average Time	D3000	10	10	CH0 Average Time
CH1 Average Time	D3001	10	10	CH1 Average Time
CH2 Average Time		10	10	CH2 Average Time
CH3 Average Time		10	10	CH3 Average Time

- (3) If users want to change the values in the data registers assigned to the parameters, they can type the setting values in the **SV** column. Users can only type the setting values in the **SV** cells for the parameters to which the data registers are assigned. If users want to change the values of parameters, they can type the setting values in the **SV** cells for the parameters, and click after the typing of the setting values is complete. The values of the parameters will be written into the data registers assigned to the parameters.

Description	Address	PV	SV	Comment
CH0 Average Time	D3000	10	20	CH0 Average Time
CH1 Average Time	D3001	10	30	CH1 Average Time
CH2 Average Time		10	10	CH2 Average Time
CH3 Average Time		10	10	CH3 Average Time

*. Before the value of a parameter is changed, users have to refer to the instructions for the module to make sure of the range of values which are allowed.

8.4.6.4 Monitoring Table

If the hardware configuration is in the online mode, users can view the values in the data registers in the **Monitor Table** window after they click **Monitor Table** on the **Option** menu. Users can not add any item to the **Monitor Table** window. After users select the checkboxes in the **Monitor** cells for parameters, the data registers assigned to the parameters will be listed in the **Monitor Table** window. Please refer to section 8.3.2 for more information.

The 'Option' menu is shown with 'Monitor Table' highlighted. The 'Parameter Setting' table below it shows the following data:

Description	Address	Monitor	Initial
CH0 Cal. Offset (V/mA)	D3008-D3009 ...	<input checked="" type="checkbox"/>	0.000000
CH1 Cal. Offset (V/mA)	D3010-D3011 ...	<input checked="" type="checkbox"/>	0.000000
CH2 Cal. Offset (V/mA)	D3012-D3013 ...	<input checked="" type="checkbox"/>	0.000000
CH3 Cal. Offset (V/mA)	D3014-D3015 ...	<input checked="" type="checkbox"/>	0.000000
CH0 Cal. Gain	D3016-D3017 ...	<input type="checkbox"/>	1.000000
CH1 Cal. Gain	D3018-D3019 ...	<input type="checkbox"/>	1.000000
CH2 Cal. Gain	...	<input type="checkbox"/>	1.000000
CH3 Cal. Gain	...	<input type="checkbox"/>	1.000000

The 'Monitor Table' window displays the following data:

Rack No.	Slot No.	Module Name	Device Name	PV	Radix	Comment
1	2	AH04AD-5A	D3008	0	Float	CH0 Cal. Offset (V/mA)
1	2	AH04AD-5A	D3010	0	Float	CH1 Cal. Offset (V/mA)
1	2	AH04AD-5A	D3012	0	Float	CH2 Cal. Offset (V/mA)
1	2	AH04AD-5A	D3014	0	Float	CH3 Cal. Offset (V/mA)

*. If the setting in the **Monitor** column in the **Parameter Setting** window is changed, the setting can take effect without having to be downloaded to the CPU module.

Users can view the values in the data registers in the **Monitor Table** window, but they can not change the values. If users want to change the values in the data registers in the **Monitor Table** window, they can follow the instructions in section 8.4.6.3. Besides, after users click the **Radix** cell for a data register, they can select a method of representing the value in the data register on the drop-down list.

The 'Monitor Table' window shows the 'Radix' dropdown menu for the third row (Device Name D3012) open, with the following options:

- Decimal
- Hexadecimal
- Binary
- Octal
- Float

8.5 Setting Interrupts

8.5.1 Program Architectures

AH500 series PLCs uses IEC 61131-3. In the IEC 61131-3 architecture, a program is divided into several program organization units (POUs). Every program organization unit can be developed independently, and can be assigned a task.

The Classic architecture and the IEC 61131-3 architecture are shown below.

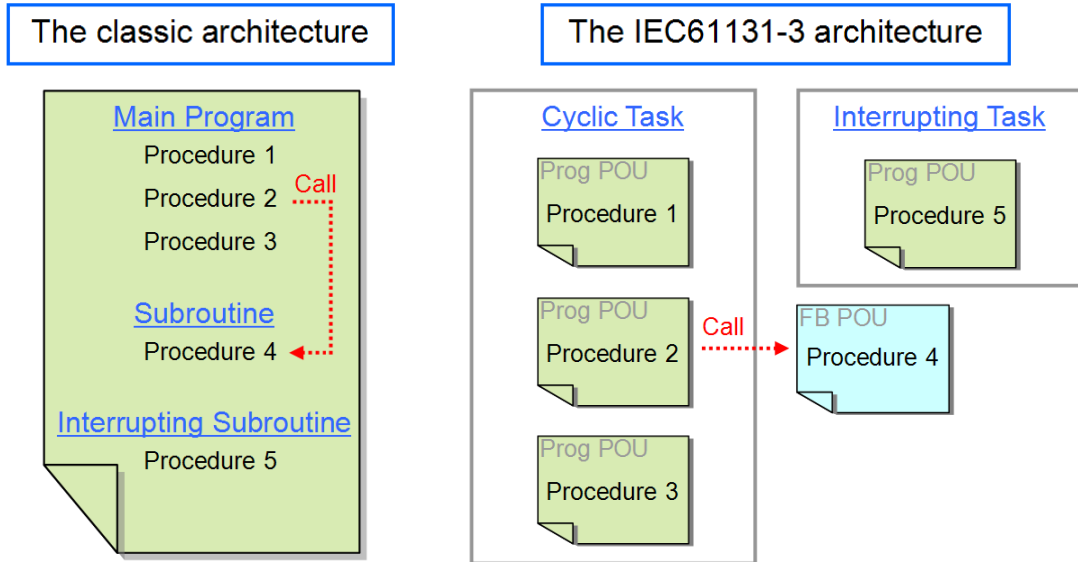

The figure below is a project created in ISPSoft. Program 4 is a POU of the function block type. The cyclic programs and the interrupt program are POUs of the program type.

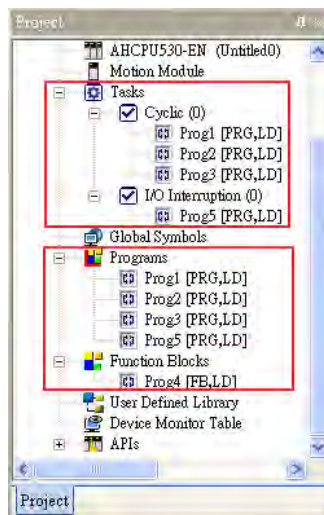

8

The interrupts supported by AH500 series CPU modules will be introduced in the following sections. Please refer to ISPSoft User Manual for more information about creating interrupts, and writing programs.

8.5.2 Tasks Supported by AH500 Series CPU Modules

The number of interrupts supported by an AH500 series CPU module is 288. There are mainly two types of tasks.

- Cyclic task 0~cyclic task 31 (32 cyclic tasks)
Cyclic tasks are executed in every scan cycle. A cyclic task can be activated/inactivated by means of the

instruction TKON/TKOFF. Users can set the initial state of a cyclic state.

Please refer to the figure below. After users click a cyclic task in the **Task Manager** window, they can set the initial state of the cyclic task in the **Task Description** section. If the **Active** checkbox is unselected, the cyclic task will not be executed until it is activated by the instruction TKON in the POU assigned to another cyclic task. Please refer to AH500 Programming Manual for more information about the instructions TKON and TKOFF.

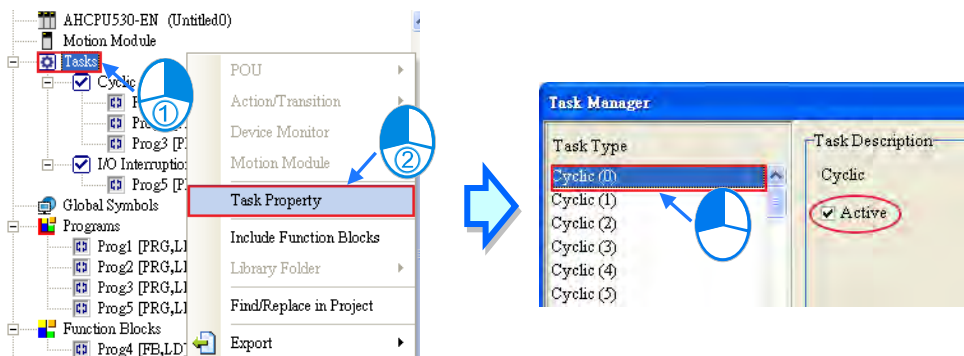

- Interrupt task 0~interrupt task 255 (256 interrupt tasks)
AH500 series CPU modules provide various kinds of interrupts. The interrupts provided by AH500 series CPU modules will be introduced in the following sections.

8.5.3 I/O Interrupts

There are 32 I/O interrupts (I0~I31).

I/O interrupts are used by special high-speed modules. Users can set interrupt conditions and interrupt numbers for a special high-speed module by means of HWCONFIG, and download the program created in ISPSOft to the special high-speed module. If an interrupt condition is met when the high-speed module runs, the corresponding interrupt will be executed.

Take AH04HC-5A for instance. The steps of setting AH04HC-5A are as follows.

- (1) After users click **CH1~4 parameter setting** in the **Parameter Setting** window, they can set **CH1/CH2/CH3/CH4 comparision function**, and **CH1/CH2/CH3/CH4 comparison interrupt output selection**.

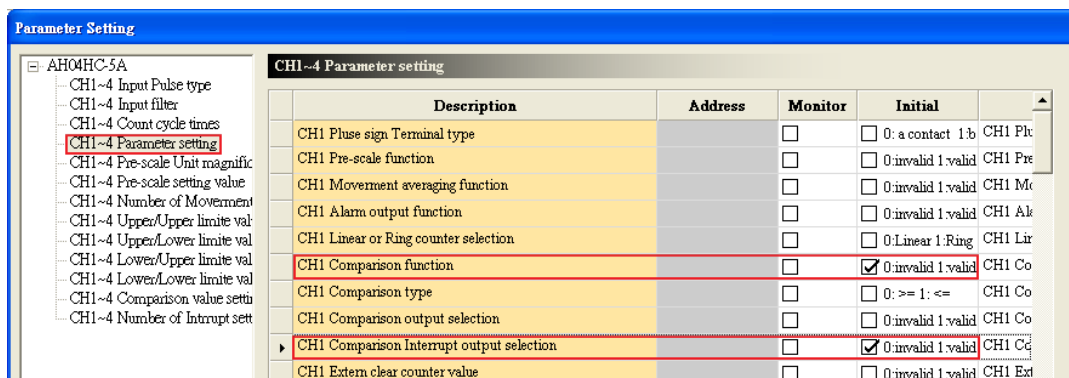

- (2) After the users click **CH1~4 comparison value setting**, they can type comparison values in the **Initial** cells.

The screenshot shows the 'Parameter Setting' window for 'AH04HC-5A'. The left sidebar lists various parameters, with 'CH1~4 Comparison value setti' highlighted. The main window displays a table titled 'CH1~4 Comparison value setting'.

Description	Address	Monitor	Initial
CH1 Comparison value setting		<input type="checkbox"/>	10
CH2 Comparison value setting		<input type="checkbox"/>	20
CH3 Comparison value setting		<input type="checkbox"/>	30
CH4 Comparison value setting		<input type="checkbox"/>	40

- (3) After the users click **CH1~4 number of interrupt setting**, they can type interrupt numbers in the **Initial** cells. If the number of pulses received by a channel is the same as the comparison value set for the channel, the corresponding I/O interrupt will be executed. However, if no POU is assigned to the I/O interrupt, or the POU assigned to the I/O interrupt is not downloaded to the special high-speed module, an error will occur in the special high-speed module.

The screenshot shows the 'Parameter Setting' window for 'AH04HC-5A'. The left sidebar lists various parameters, with 'CH1~4 Number of Interrupt setti' highlighted. The main window displays a table titled 'CH1~4 Number of Interrupt setting'.

Description	Address	Monitor	Initial
CH1 Number of interrupt setting for Comparison		<input type="checkbox"/>	0
CH2 Number of interrupt setting for Comparison		<input type="checkbox"/>	1
CH3 Number of interrupt setting for Comparison		<input type="checkbox"/>	2
CH4 Number of interrupt setting for Comparison		<input type="checkbox"/>	3

8.5.4 Low Voltage Detection Interrupt

The terminals VS+ and VS- on AHPS05-5A can check whether the external voltage is 24 volts. If the external voltage is abnormal, the interrupt subroutine I34 will be executed.

Note: If the voltage supplied to a backplane is abnormal, the corresponding bit in SR731 will be set to ON. After the external voltage supplied to the backplane returns to normal, the bit will be set to OFF. Bit 0~bit 7 in SR731 are for backplanes. The remaining bits in SR731 are reserved bits.

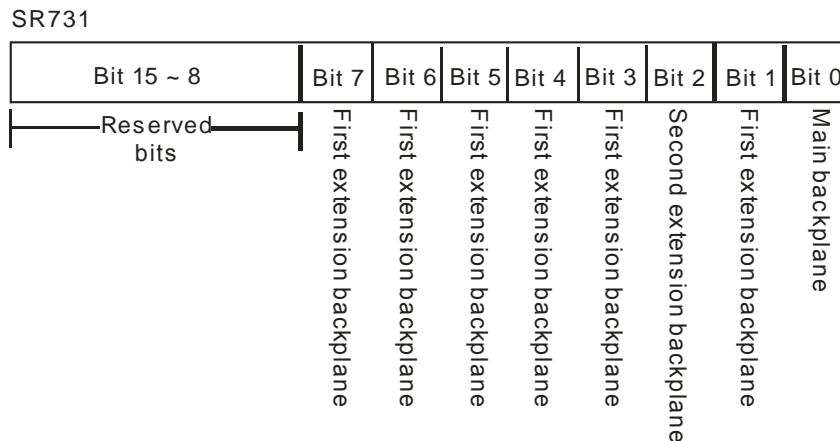

8.5.5 Communication Interrupts

A communication interrupt can be used as the instruction RS, that is, the reception of a specific character triggers a communication interrupt. A communication interrupt can also be used as a general interrupt. Please



refer to AH500 Programming Manual for more information about the instruction RS.

COM1: I32

COM2: I33

8.5.6 External Interrupts

There are 212 external interrupts (I40~I251). If a peripheral device sends an interrupt request, the corresponding interrupt task will be executed. Take AH06XA-5A for instance. The steps of setting AH06XA-5A are as follows.

- (1) After users click **Channel mode setting** in the **Parameter Setting** window, they can set **CH0/CH1/CH2/CH3 input mode setting**.

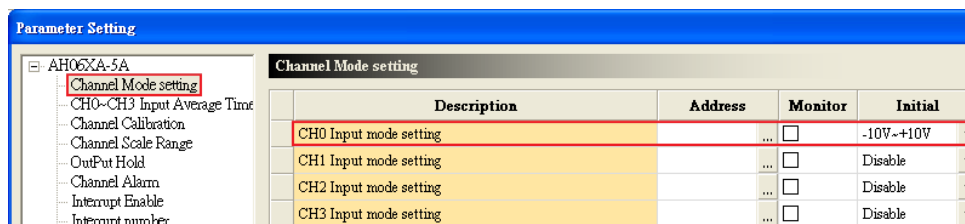

- (2) After users click **Interrupt enable**, they can set **CH0/CH1/CH2/CH3 interrupt of over physics Range**.

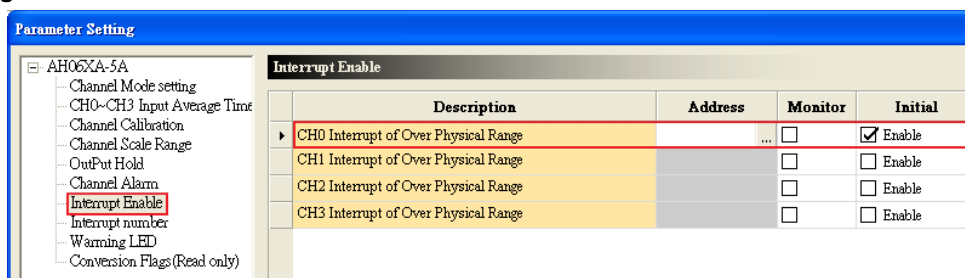

- (3) After the users click **Interrupt number**, they can type interrupt numbers in the **Initial** cells.

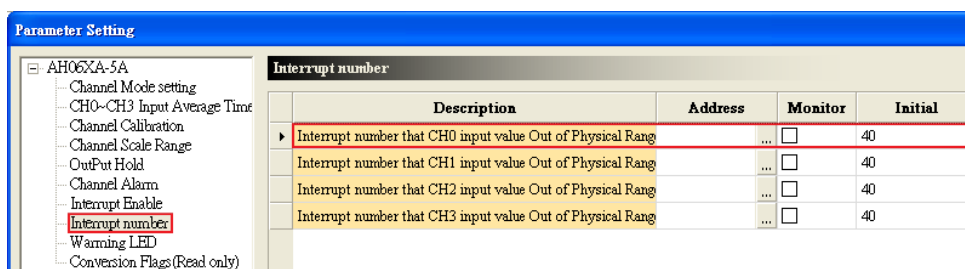

8

If an input signal received by input channel 0 exceeds the range, the external interrupt I40 will be triggered. However, if no POU is assigned to the external interrupt I40, or the POU assigned to the external interrupt I40 is not downloaded to the special high-speed module, an error will occur in AH06XA-5A.

- Interrupts can not be executed simultaneously. If other interrupts are triggered when one interrupt is executed, the interrupts triggered will be recorded. After the execution of the interrupt is finished, the interrupt which has priority over the other interrupts will be executed next.
- If an interrupt is triggered repeatedly when it is executed, only one interrupt will be recorded, and the other interrupts will be ignored.

Users can not set two different interrupt conditions for one interrupt number. For example, if I220 is used by a network module, it can not be used by an analog input/output module.

8.5.7 Timer Interrupts

There are four timer interrupts (I252~I255).

Timer interrupt 0 (I252): The default value is 100 milliseconds (1~1000 milliseconds).

Timer interrupt 1 (I253): The default value is 40 milliseconds (1~1000 milliseconds).

Timer interrupt 2 (I254): The default value is 20 milliseconds (1~1000 milliseconds).

Timer interrupt 3 (I255): The default value is 10 milliseconds (1~1000 milliseconds).

A timer interrupt is executed every specific period of time. For example, the timed interrupt task is executed every 10 milliseconds. Users can set the timer interrupts in the **PLC Parameter Setting** window.

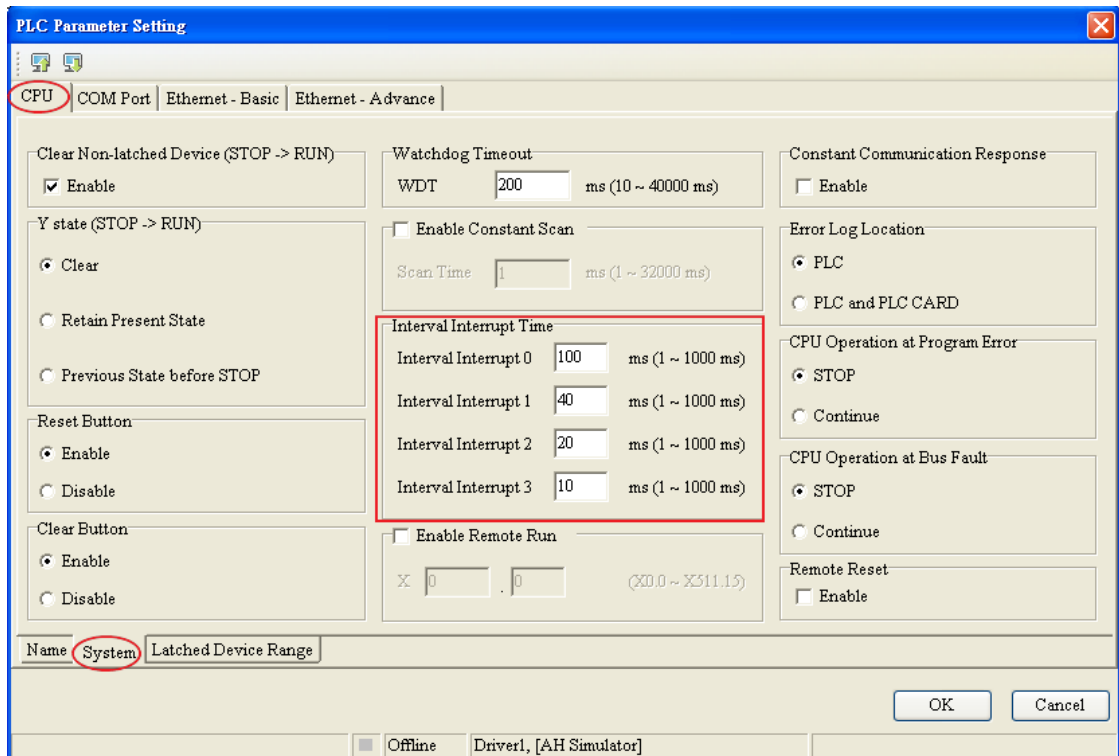

MEMO

8

9

Chapter 9 Network Configuration (Applicable for AHCPU5X0 Models)

Table of Contents

9.1	Network Configuration Tool—NWCONFIG	9-2
9.1.1	Introduction of NWCONFIG.....	9-2
9.1.2	Basic Knowledge	9-3
9.1.3	Communication Setting in NWCONFIG.....	9-4
9.1.3.1	Connection Mechanism in NWCONFIG.....	9-5
9.1.3.2	Setting Communication Parameters	9-6
9.1.4	Workflow.....	9-7
9.2	Creating a Network Architecture	9-12
9.2.1	Deploying Nodes.....	9-12
9.2.2	Connecting to a Network.....	9-15
9.2.3	Adjusting or Deleting Devices or Networks.....	9-20
9.2.4	Setting the Attributes of a Node/Network.....	9-23
9.2.5	Hiding/Displaying Devices or Networks	9-27
9.2.6	Correct Network Architecture	9-30
9.2.7	Downloading Routing Tables	9-33
9.2.8	Testing Routing	9-34
9.3	Managing and Applying NWCONFIG	9-36
9.3.1	Saving Parameters and Printing a Network Framework	9-36
9.3.2	Downloading Parameters.....	9-37
9.3.2.1	Introduction of Parameters	9-37
9.3.2.2	Description of Downloading Parameters.....	9-38
9.3.3	Using Routing in ISPSOft.....	9-39

9.1 Network Configuration Tool—NWCONFIG

9.1.1 Introduction of NWCONFIG

NWCONFIG is the network configuration tool provided by ISPSOft. Users can configure the network in a project and set up a mechanism for data exchange through NWCONGIF. The functions of NWCONFIG are listed below. They will be described in the following sections.

- (a) Creating networks in a project, and selecting paths along which data is sent
- (b) Performing data exchange through an RS-485 cable—PLC Link
- (c) Performing data exchange through Ethernet—Ether Link

NWCONFIG is used to create a network framework for projects, and therefore it is at the top of the project management area. If users want to start NWCONGIF, they can double-click **NWCONFIG** in the project management area.

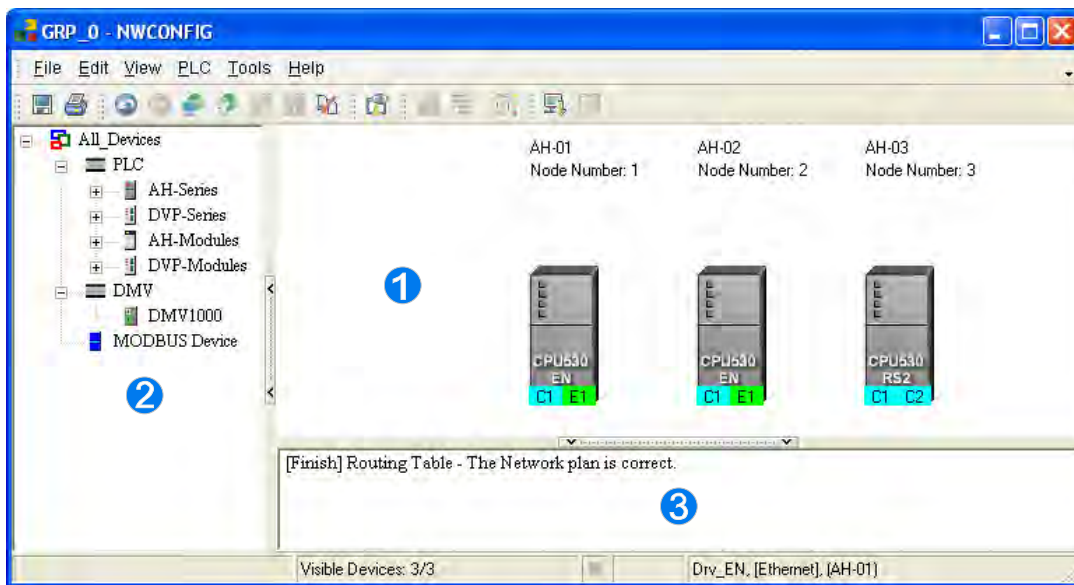
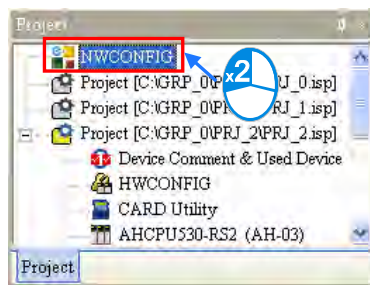

- ① Working area:** It is a main working area. Users can create a network framework in this area.
- ② Device list:** All the devices which can be used are listed in a catalog.
- ③ Message display area:** The messages related to operation are displayed in this area.

9.1.2 Basic Knowledge

Before creating networks, users need to have some basic knowledge. The basic knowledge is introduced in this section.

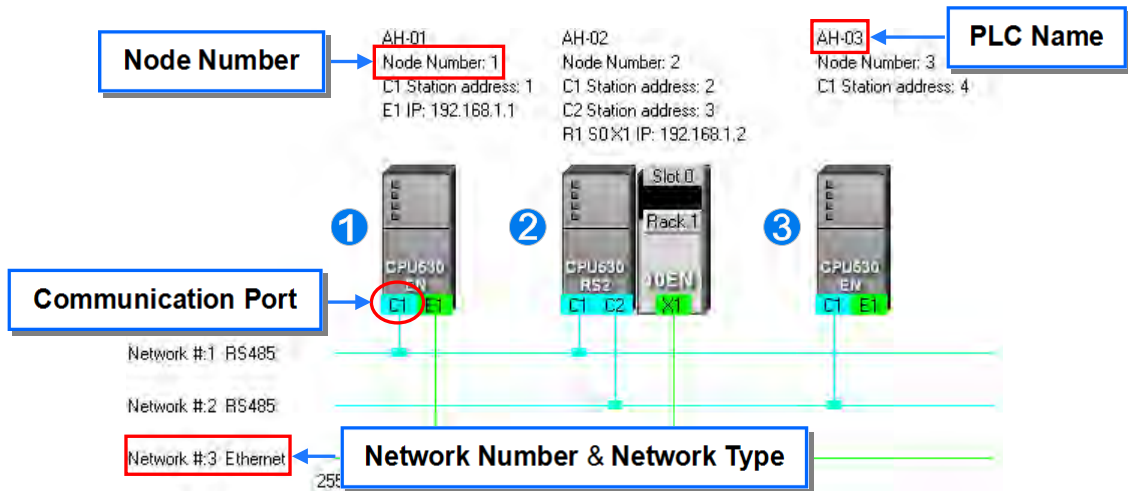

- **Device and network**

A device is the most basic element in a network. It is a PLC, a module, or equipment defined by users. A network is a collection of devices which are interconnected. Every network is assigned a network number. There are RS-485 networks and Ethernet networks. Besides, a physical interface that a device uses to connect to a network is a port of the device. If there are more than two ports on a device, the device can connect to networks which are assigned different network numbers. Please refer to section 9.2.2 for more information about the marking of a port in NWCONFIG.

- **PLC name**

“AH-01”, “AH-02”, and “AH-03” in the figure above are PLC names. The PLC name of an AH500 series CPU module depends on the setting in HWCONFIG. Users can identify a device in a network by means of the PLC name of the device. Please refer to section 8.2.2.1 for more information. However, the PLC name of a device which is not an AH500 series CPU module is like a comment on the device. It has little significance.

- **Node and node number**

A node is a basic unit which can operate independently in a network. ① ~ ③ in the figure above are nodes. ② consists of a CPU module and a network module. The network module can not operate by itself, and therefore the CPU module and the network module are regarded as one node.

Besides, AH500 series CPU modules can forward packets and perform routing. For example, ③ in the figure above can be monitored through ①. Before routing is performed, users have to create paths along which data is sent, and assign node numbers to the nodes which forward the data along the paths. Only AH500 series CPU modules can be assigned node numbers, and the node number of a node in a network can not be the same as the node number of another node in the network. After the paths created are downloaded to the PLCs which forward the data along the paths, every PLC has its own routing table. The forwarding of the data is directed on the basis of the routing tables produced.

- **Station address**

Users can identify a port in an RS-485 network by means of the station address of the port. The station address of a port in a network can not be the same as the station address of another port in the network. Besides, a port is assigned a station address. A port basically represents a station. If a node has several ports, the ports connected to networks must be assigned station addresses.

- **IP address and DHCP mode**

A port in an Ethernet network is assigned an IP address. The IP address of a port in a network can not be the same as the IP address of another port in the network, and an IP address can not end with 0 or 255. If a node has several Ethernet ports, the Ethernet ports connected to an Ethernet network must be assigned IP addresses.

DHCP is a protocol for assigning dynamic IP addresses to ports in a network. If a server using DHCP assigns

an IP address to a port, it assigns a dynamic IP address to the port. In NWCONFIG, the ports which are assigned dynamic IP addresses can not connect to any network.

- **Subnet mask**

A subnet mask is a mask used to determine what subnet an IP address belongs to. The ports in a network are assigned the same subnet mask. Besides, if the devices in a network want to perform data exchange, they must be in the same domain.

- **PLC Link**

A PLC Link is a network mechanism for data exchange performed through an RS-485 cable. If there are several nodes in an RS-485 network, users can create a mechanism for data exchange in the network. If the parameters which are set are downloaded to the PLC which functions as a master station, the system of the PLC will perform data exchange through special relays and special registers when the PLC runs.

A PLC Link is a master/slave model. There is only one master station in an RS-485 network, and the other stations which are slave stations passively receive reading/writing commands from the master station. The slave stations can not exchange data. They have to exchange data through the master station.

- **Ether Link**

An Ether Link is a network mechanism for data exchange performed through an Ethernet connection. If there are several nodes in an Ethernet network, users can create a mechanism for data exchange in the network, and select a start mode. If the parameters which are set are downloaded to the PLCs in the network, the systems of the PLCs perform data exchange according to the start mode selected when the PLCs run. Besides, only AH500 series CPU modules support Ether Links.

An Ether Link is not a master/slave model. It allows a node to send reading commands which ask for data to other nodes. The nodes will send the data to the node after they receive the reading commands. Owing to the fact that a node can not send writing commands to other nodes, the use of an Ether Link is safer than the use of a PLC Link. Besides, the system automatically manages the transmission of packets through TCP/IP. Compared with a PLC Link, an Ether Link is more efficient.

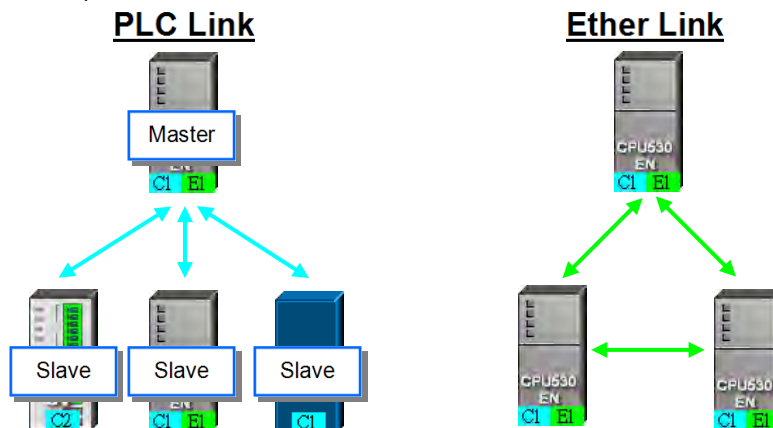

*. Please refer to related books or technical documents for more information about RS-485 and Ethernet.

9.1.3 Communication Setting in NWCONFIG

NWCONFIG is used to configure a network. When users configure a network, they have to download parameters to the nodes in the network, upload parameters from the nodes in the network, or monitor nodes in the network. The nodes in the networks created in NWCONFIG may include a device which is not the device for which the ISPSOFT project is created, and therefore users have to set the communication parameters in the device. In order to help people select appropriate parameters, the communication mechanism in NWCONFIG is introduced before communication setting is described.



9.1.3.1 Connection Mechanism in NWCONFIG

In the networks created in NWCONFIG, users can download parameters to a single node or multiple nodes, upload parameters from a single node or multiple nodes, and monitor a single node or multiple nodes. Before users download parameters to a single node or multiple nodes, upload parameters from a single node or multiple nodes, or monitor a single node or multiple nodes, they have to select appropriate parameters.

- **Single node**

Users can download parameters to a single device, upload parameters from a single device, and monitor a single device. Before users download parameters to a single device, upload parameters from a single device, or monitor a single device, they have to make sure that the device specified is the same as the device which is actually connected to the computer.

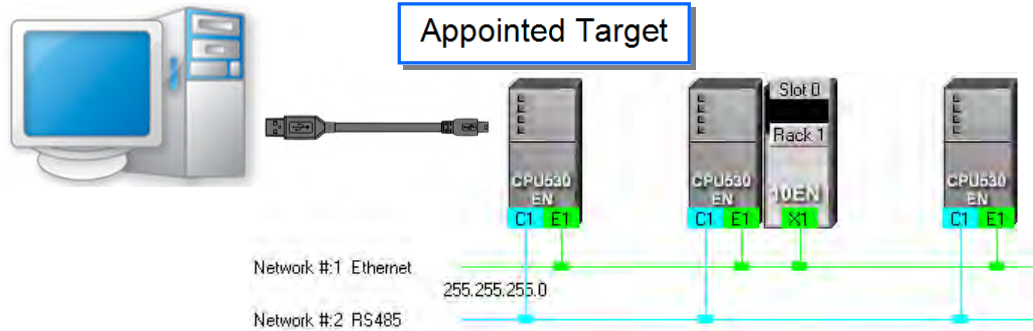

- **Multiple nodes**

In a network, users can download parameters to multiple devices, upload parameters from multiple devices, and monitor multiple devices. Before users download parameters to multiple devices, upload parameters from multiple devices, or monitor multiple devices, they have to make sure that the devices are connected to an Ethernet network, the devices are assigned IP addresses, and the connection type that the driver uses is Ethernet.

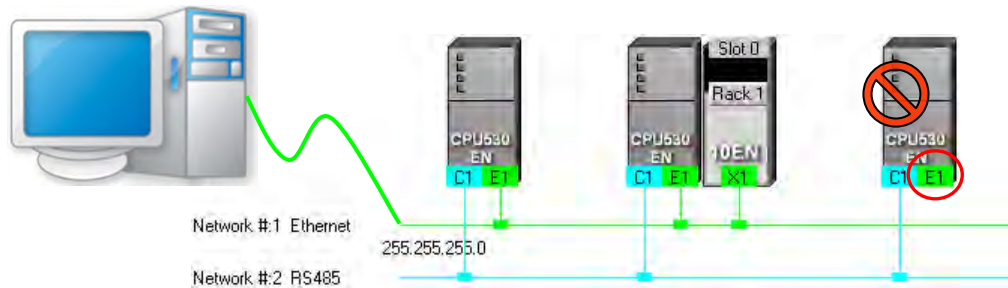

If the connection type that the driver selected uses is Ethernet, the system will carry out communication according to the IP addresses assigned to the devices in NWCONFIG. Before the communication is carried out, users have to make sure that the IP addresses actually assigned to the devices are the same as the IP addresses set in NWCONFIG, and the networks actually created are the same as the networks created in NWCONFIG. Otherwise, an error will occur if the communication is carried out.

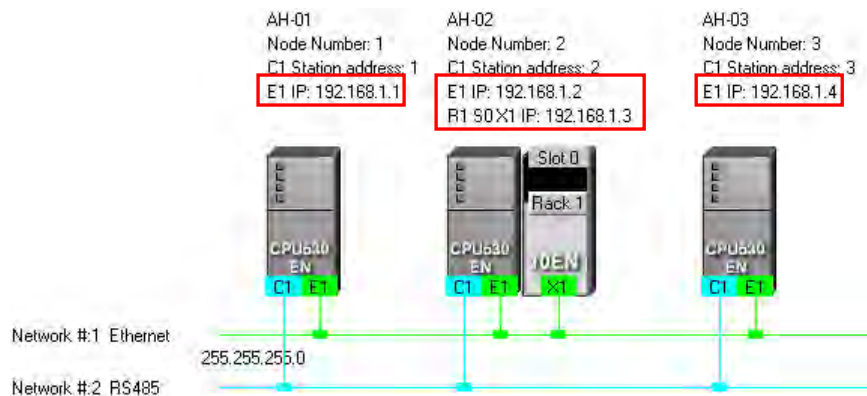

NWCONFIG can also carries out communication through routing.

Routing is a function provided by AH500 series CPU modules. It directs packet forwarding. Packet forwarding is the relaying of packets from their source toward their destination through intermediate nodes. In the figure below, the device which actually connects to the computer is AH-01. If the computer wants to connect to AH-03, it can communicate with it through routing, and designates AH-01 as the first station. After the computer sends a command, the command is transmitted to AH-03 through AH-01 and AH-02.

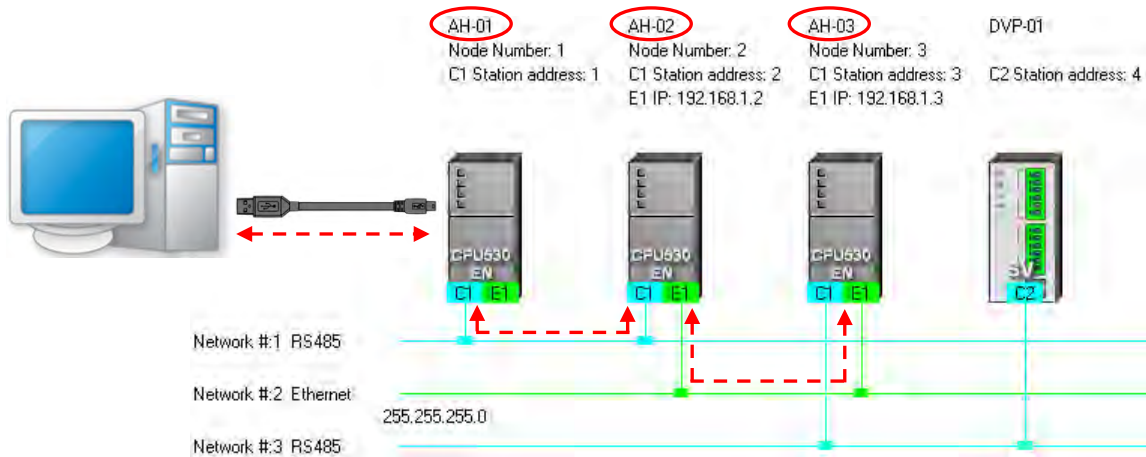

The important points about routing are listed below.

- Users have to create networks in NWCONFIG, and download the routing tables produced to nodes in the networks. Please refer to section 9.2 for more information.
- AH500 series CPU modules support routing whereas DVP series PLCs and other devices do not support routing. Although DVP series PLCs and other devices can not function as intermediate nodes through which packets pass, they can function as destinations to which packets are transmitted.

9.1.3.2 Setting Communication Parameters

The steps of setting the communication parameters in NWCONFIG are as follows. Some prerequisites have to be considered. Please refer to section 2.4 in ISPSOFT User Manual for more information

- Start the communication manager COMMGR, and then create a driver in COMMGR.
- If users want to download parameters to a single device, upload parameters from a single device, or monitor a single device, they have to make sure that the device specified is the same as the device which is actually connected to the computer. If the users want to download parameters to multiple devices, upload parameters from multiple devices, or monitor multiple devices, they have to make sure that the devices are connected to an Ethernet network, the devices are assigned IP addresses, the IP addresses actually assigned to the devices are the same as the IP addresses set in NWCONFIG, and the networks actually created are the same as the networks created in NWCONFIG.
- Click **Communication Setting** on the **Tools** menu or  on the toolbar in the NWCONFIG window. After the users complete the setting described below, they can click **OK** in the **Select a Driver** window.

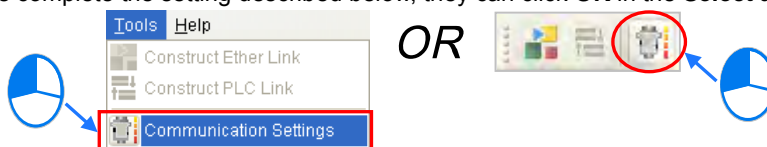

- (4) Select a driver in the **Driver Name** drop-down list box. If the users want to download parameters to a single device, upload parameters from a single device, or monitor a single device, they have to select a driver which can connect to the device specified. If the users want to download parameters to multiple devices, upload parameters from multiple devices, or monitor multiple devices, the connection type that the driver selected uses must be Ethernet. The users have to make sure that the driver selected is started.



- (5) The users have to make sure that the routing tables produced are downloaded to nodes in the networks before they use routing. If the users want to use routing, they have to select the **Routing Mode** checkbox, and select a device in the **First Station** drop-down list box. Generally speaking, the device which actually connects to the computer is the first station. If the computer connects to several devices, or connect to devices through Ethernet, the users have to designate a device as the first station according to the network framework created in NWCONFIG. Besides, if the **Routing Mode** checkbox is selected, the driver selected in the **Driver Name** drop-down list box must be a driver which can connect to the first station.

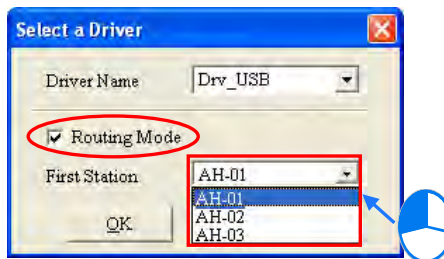

9.1.4 Workflow

The creation of networks involves the operation of a system, and therefore the workflow needed must consist of a sequence of connected steps. The workflow needed to create networks is introduced briefly in this section, and will be described in length in the following sections. The workflow introduced in this section is a method which can be used to efficiently complete work in a general condition. It is not necessarily applicable to all conditions. Users can adjust the workflow according to the actual situations or their habits.

- (1) Before users create a system by means of ISPSOft, they have to design networks. The users have to decide what PLCs or devices are used in the networks, whether a PLC needs to be connected to a network module, how the nodes in the networks are connected, what IP address or RS-485 station address are assigned to the ports connected, and what the values of RS-485 communication parameters are. Besides, the users have to decide what devices perform data exchange. The data exchange is related to the programs in the PLCs used in the networks. After the users design networks, they can create the networks in ISPSOft.

- (2) Create a project in ISPSOft. If there are more than two Delta PLCs in a system, it is recommended that the users should create a group of projects in ISPSOft. Please refer to section 2.2 in ISPSOft User Manual for more information.

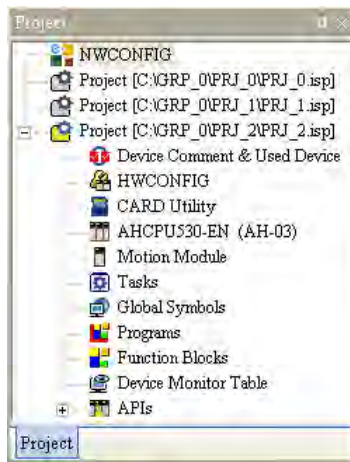

- (3) If there are projects for AH500 series CPU modules, the users have to open the HWCONFIG windows in the projects, and complete hardware configurations. The users have to configure modules, set the parameters in network modules, gives names to the CPU modules, set ports, and set Ethernet ports. Please refer to chapter 8 for more information.

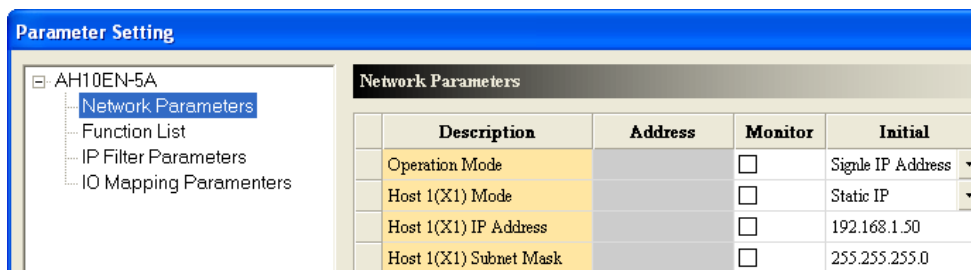
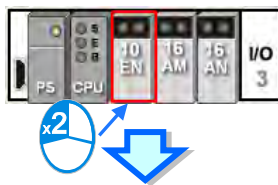

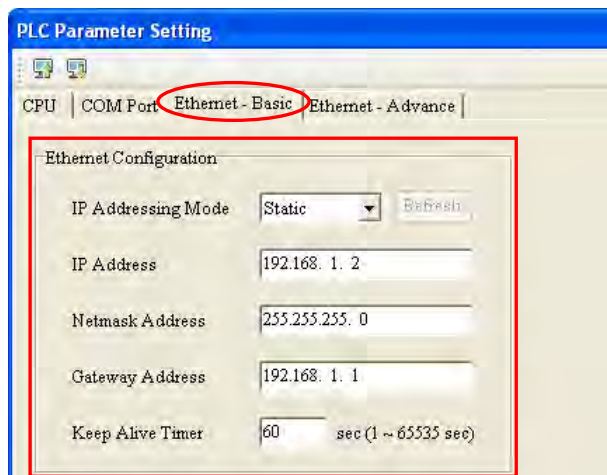
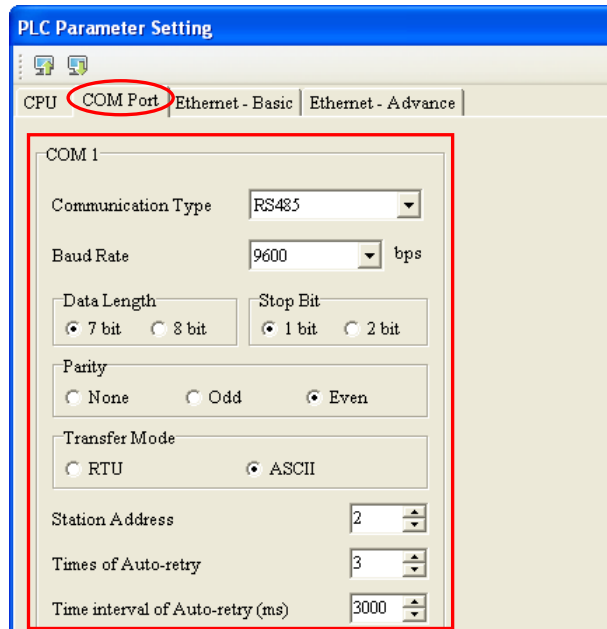
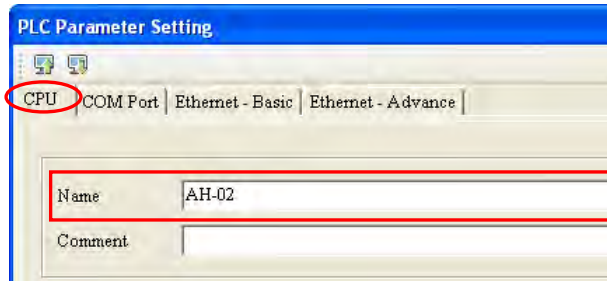

(4) Complete a network configuration in NWCONFIG.

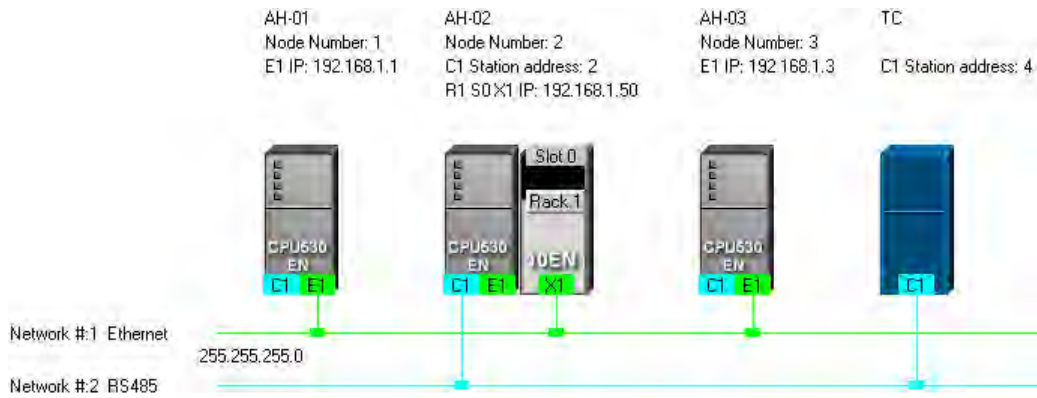

(5) Create a mechanism for data exchange performed by means of a PLC Link or an Ether Link. A PLC Link and an Ether Link operate independently. The users can create them in any order. The addresses involved in data exchange can not overlap, otherwise an error will occur after the data exchange is performed. It is recommended that the users should set addresses which are involved in data exchange according to the programs in the projects created.

The figure below is a table related to data exchange performed by means of a PLC Link. After the users complete the setting in the table, the master station in NWCONFIG will be marked.

#	Station Addr.	R/W	Master Device Data	<=>	Slave Device Data	Length	Status	Device Type
1	4	R	D3000~D3000	<=	16#1000~16#1000	1	Enabled	MODBUS Device
		W	D3001~D3001	=>	16#1001~16#1001	1		
2	0	R	D100	<=	D4096	0	Disabled	Unknown
		W	D100	=>	D4096	0		
3	0	R	D200	<=	D4096	0	Disabled	Unknown
		W	D200	=>	D4096	0		
4	0	R	D300	<=	D4096	0	Disabled	Unknown
		W	D300	=>	D4096	0		
5	0	R	D400	<=	D4096	0	Disabled	Unknown
		W	D400	=>	D4096	0		

Export Reset Check Settings Upload Download Monitor and Download ← Finish

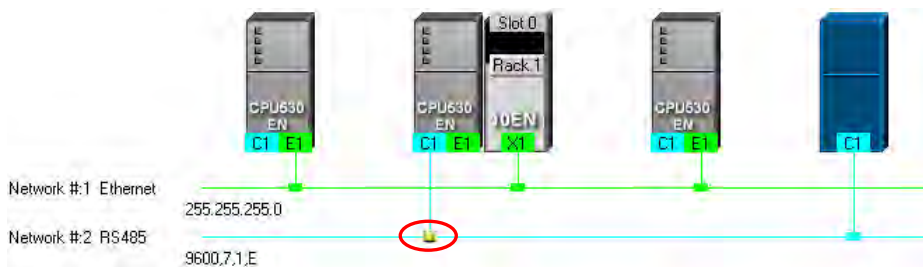

The figure below is a table related to data exchange performed by means of an Ether Link.

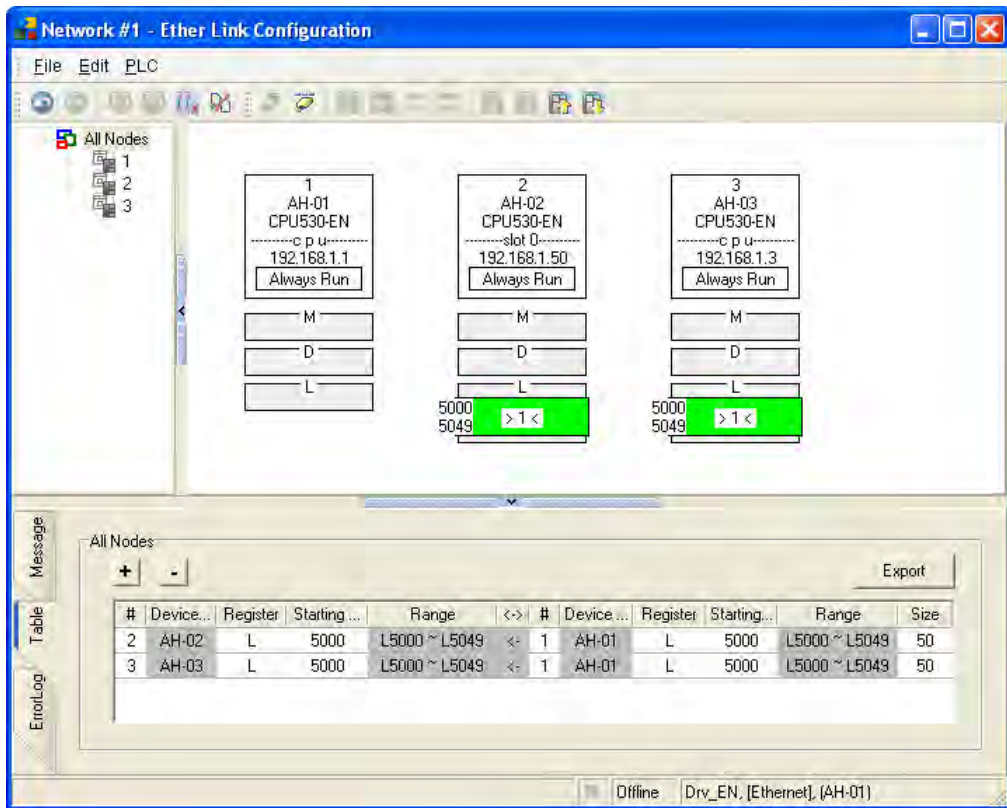

- (6) Download the programs in the projects, the parameters set in HWCONFIG, and the parameters set in NWCONFIG to the PLCs. If the devices in the networks designed include DVP series PLCs or devices which are not AH500 series CPU modules, the users have to set the communication parameters in these DVP series PLCs or devices which are not AH500 series CPU modules. The Optional Download window in NWCONFIG is shown below. The items which can be downloaded vary with the node selected.

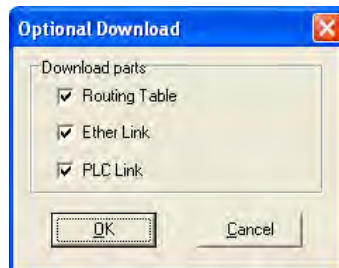

- (7) Before the users start the system, they have to create actual networks according to the networks created in NWCONFIG.

9.2 Creating a Network Architecture

9.2.1 Deploying Nodes

After users open the NWCONFIG window for projects for the first time, the devices for which the projects are created will be deployed in the working area in the NWCONFIG window. If the devices deployed in the working area include AH500 series CPU modules, the modules connected to the CPU modules, the parameters in the CPU modules, and the parameters in the modules connected to the CPU modules will be displayed according to the setting in HWCONFIG. The devices deployed in the working area can not be changed or deleted.

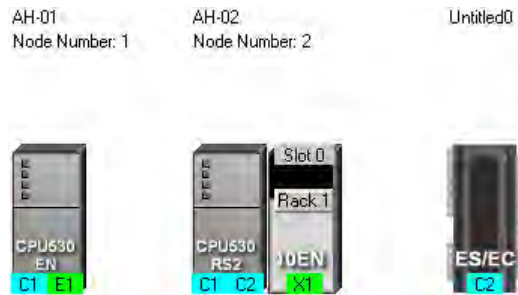

The users can add other PLCs or devices to the working area. There are two ways to add a new device to the working area.

- **Method 1**

Select a PLC or a device on the device list. After the users double-click the PLC or the device, the PLC or the device will be put at the right side of the rightmost device in the working area.

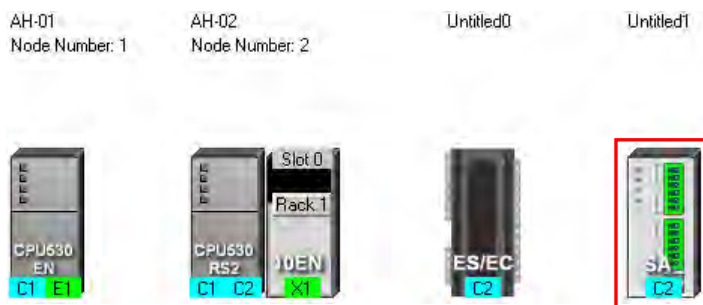
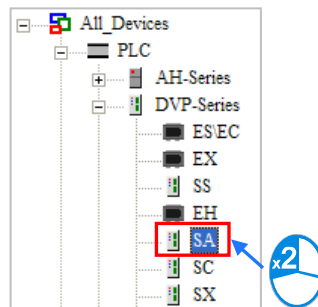

● **Method 2**

Select a PLC or a device on the device list, and then drag it to a position in the working area.

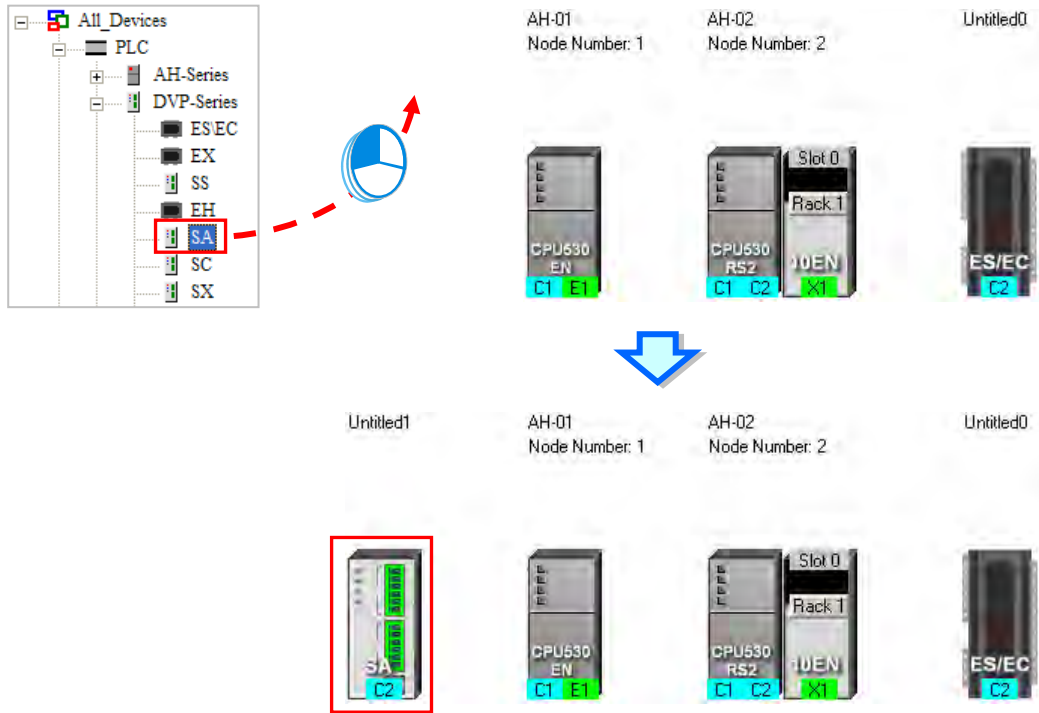

The users can add a user-defined Modbus device to the working area. After the users select **MODBUS Device** on the device list, and add it to the working area in one of the two ways described above, the **Custom Device** window will appear. The users have to type a name in the **Name** box, select a number in the **The number of ports** drop-down list box, and click **OK**. (A user-defined Modbus device can have three ports at most.)

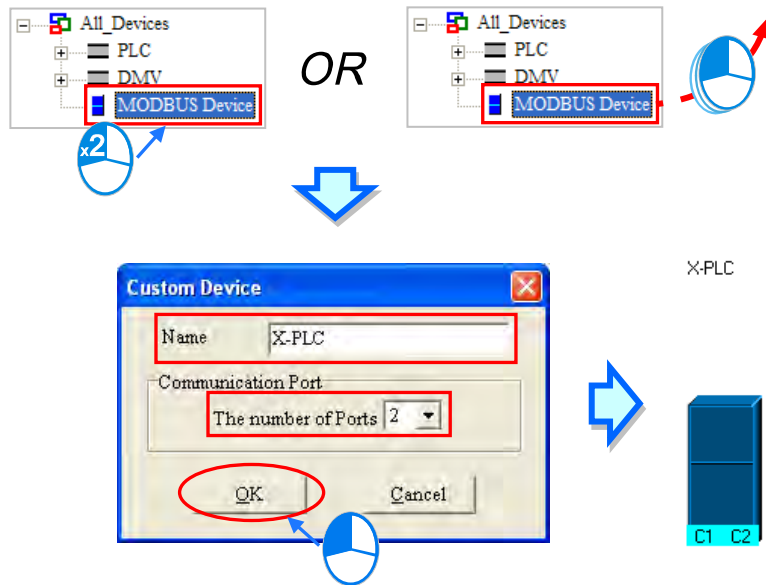



The users can add network modules to the working area. However, if the devices deployed in the working area include AH500 series CPU modules for which projects are created, the users can not connect network modules to the CPU modules. If the users want to connect network modules to the CPU modules, they have to close the NWCONFIG window, configure the network modules in HWCONFIG, and save the setting in HWCONFIG. After the users open the NWCONFIG window again, the system will update the network configuration in NWCONFIG. Besides, the users can directly connect network modules to the DVP series PLCs in the NWCONFIG window.

There are two ways to add a network module to the working area.

● **Method 1**

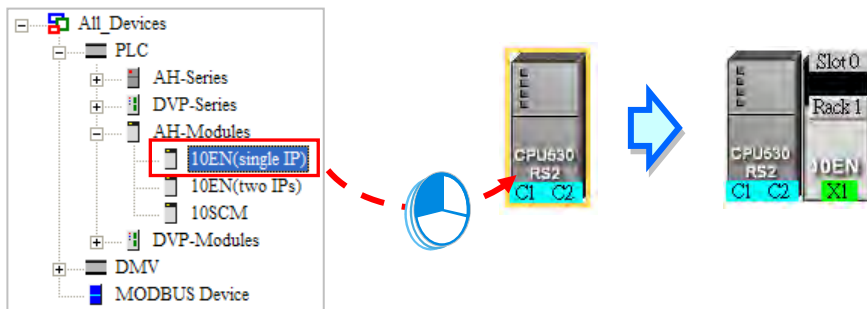
Select a network module on the device list, and then drag it to a PLC in the working area.



If the PLC does not support the network module selected, the mouse cursor becomes .



An AH10EN series module can only be put on a main backplane. Eight AH10EN series modules at most can be put on a main backplane. An AH10SCM series module can be put on an extension backplane. The number of AH10SCM series modules which can be put on a backplane depends on the number of slots on the backplane.

Users can choose a backplane to which an AH10SCM series module is dragged.

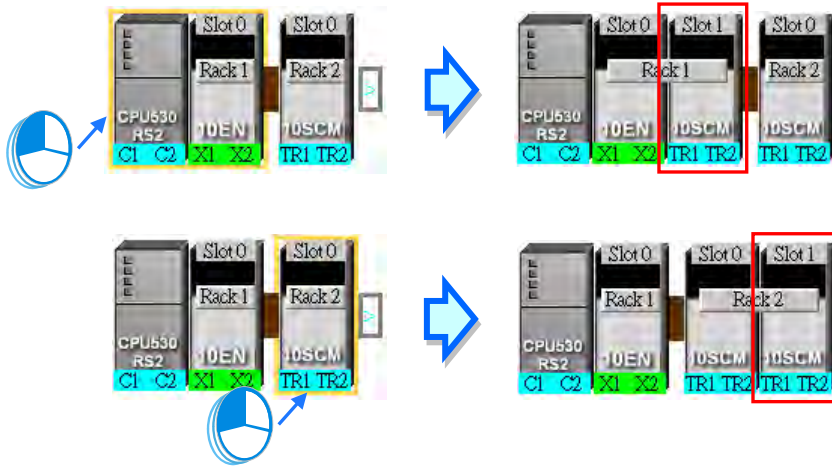

After the users drag an AH10SCM series module to  at the right side of a node, an extension rack will be added to the node.

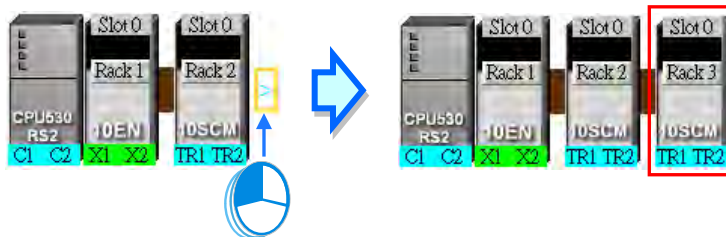

9

● **Method 2**

Select a PLC or a rack in the working area, and then double-click a network module on the device list.

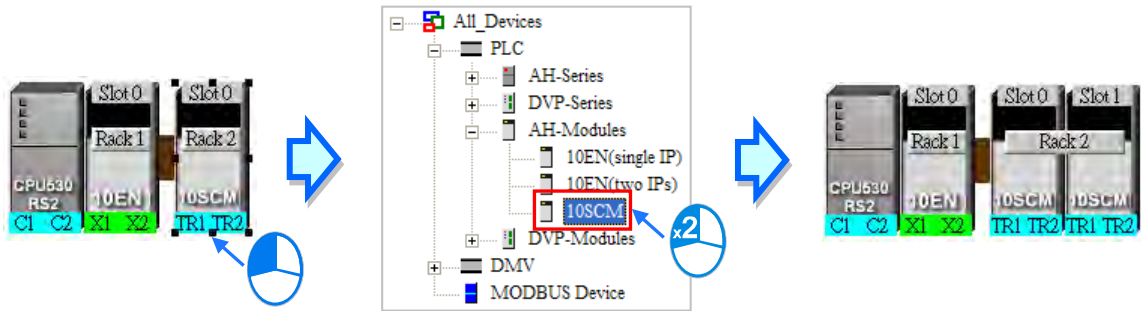

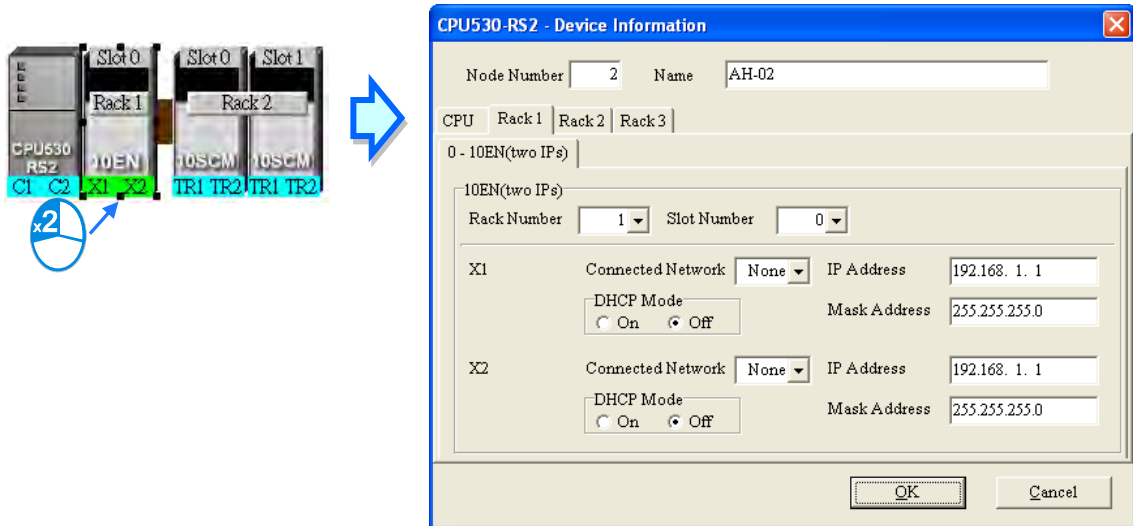

After the users add a network module to a node, the slot in which the network module is installed, and the backplane on which the network module is installed may be different from the actual slot in which the network module is installed, and the actual backplane on which the network module is installed. The users have to adjust the properties of the node. Please refer to section 9.2.4 for more information about setting properties of a node, and section 9.2.2 for more information about the marking of a port in NWCONFIG.



9.2.2 Connecting to a Network

After users deploy the nodes in the NWCONFIG window, they can connect the nodes to the networks designed. There are three ways to add a network to the working area. There are Ethernet networks and RS-485 networks.

● **Method 1**

After users click  on the toolbar, an Ethernet network is added. After the users click  on the toolbar, an RS-485 network is added.



● **Method 2**

Click the **Edit** menu, point to **Add a Network**, and click **Ethernet** or **RS-485**.

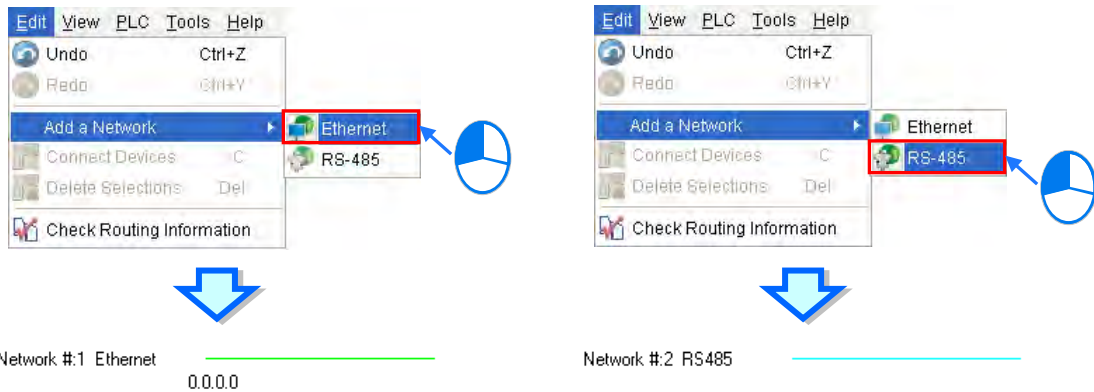

● **Method 3**

Right-click the blank in the working area, point to **Add a Network** on the context menu, and click **Ethernet** or **RS-485**.

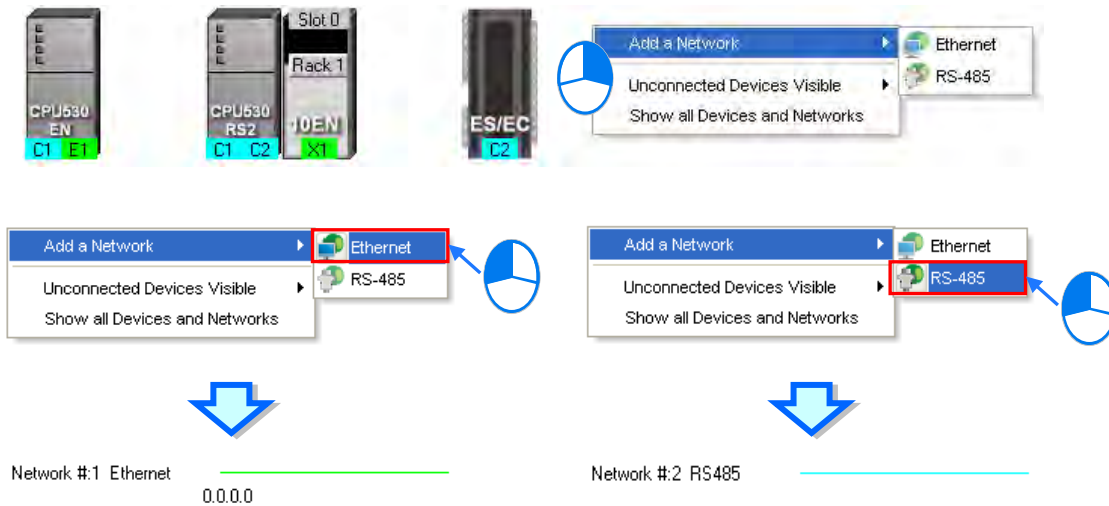

The ports of a device are displayed at the bottom of the device. If a port is blue, it is an RS-485 port. If a port is green, it is an Ethernet port. The port number assigned to a port of a device is consistent with the definition of the port. For example, E1 represents the first Ethernet port, C1 represents COM1, and C2 represents COM2. The ports of an AH10SCM series module are marked with TR1 and TR2, and the ports of an AH10EN series module are marked with X1 and X2. Besides, if the IP address assigned to an Ethernet port is a dynamic IP address, or a port of an AH10SCM series module is not a Modbus port, the Ethernet port or the port of the AH10SCN series module will be gray, and can not connect to any network.



There are several ways to connect the nodes in the working area to networks.

- **Connecting a port to a network by means of dragging the port**

The users press the left mouse button while the mouse cursor hovers over a port. A dotted line is under the existing network.

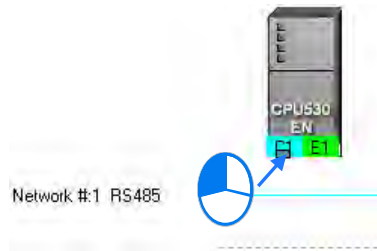

The users move the mouse cursor to the existing network while holding the left mouse button down. If the network matches the port, the port will connect to the network after the users release the left mouse button.



If the users move the mouse cursor to the dotted line while holding the left mouse button down, the port will connect to a network which matches the port.

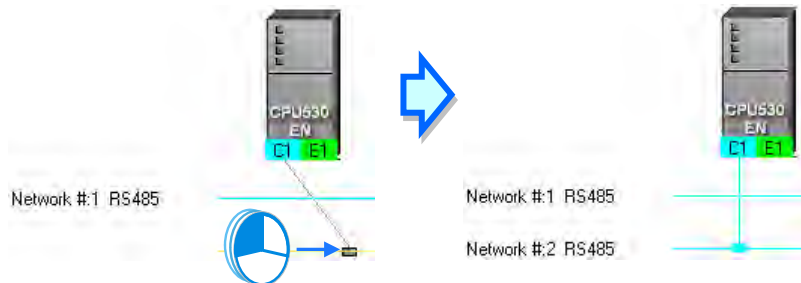

- **Connecting a single device or several devices to an existing network**

(1) The users hold down Shift on the keyboard while they click devices and a network. They have to conform to the two principles below.

- (a) PLCs and modules are independent devices. A device that the users click must have at least one port which is not connected to any network, and matches the network clicked.
- (b) The users can click several devices, but they can only click one network.



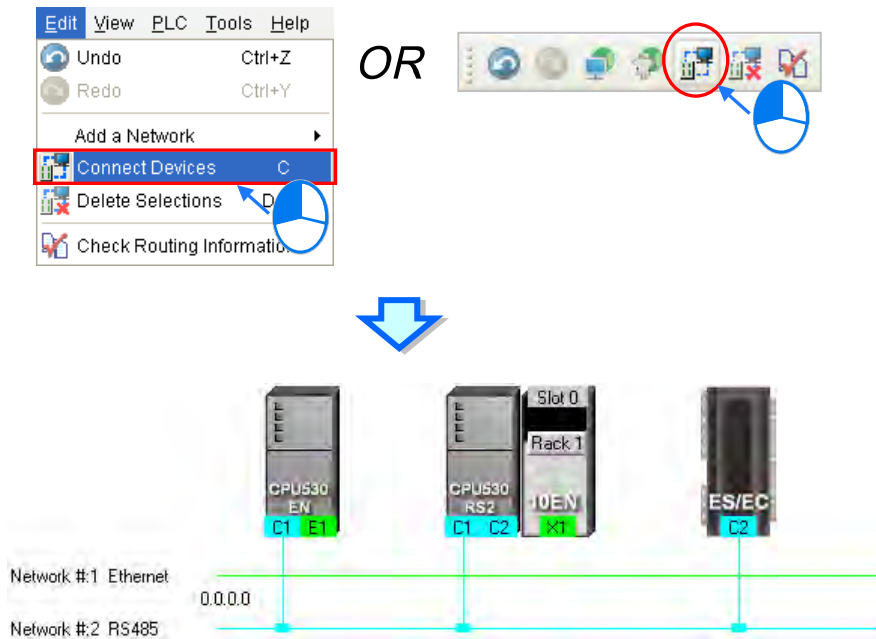

- (2) After the users click **Connect Devices** on the **Edit** menu, or  on the toolbar, the system will connect the devices clicked to the network clicked.

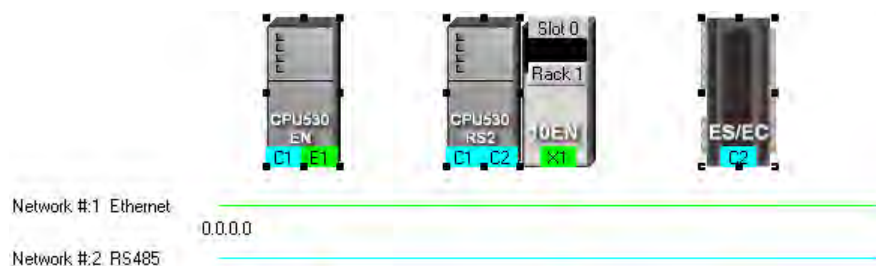

Additional remark

- (a) If the objects selected do not conform to the two principles listed above, the system will not connect the devices selected to the network selected, and a warning message will appear.
 - (b) If a device selected has more than one port which is not connected to any network and matches the network selected, the system will connect the port whose port number is smaller to the network selected.
 - (c) Users can select multiple devices by dragging a selection net around them. If the users press Ctrl+A on the keyboard, all the devices and networks in the working area are selected.
 - (d) If users select a node which consists of a PLC and a module, and the PLC and the module conform to the principles listed above, the system will connect a port of the PLC and a port of the module to the network selected.
- **Automatically connecting a single device or several devices to a new network**
 - (1) The users hold down Shift on the keyboard while they click devices. PLCs and modules are independent devices. A device that the users click must have at least one port which is not connected to any network, and matches the new network added.



- (2) After the users click **Connect Devices** on the **Edit** menu, or  on the toolbar, the system will connect the devices clicked to the new network added.

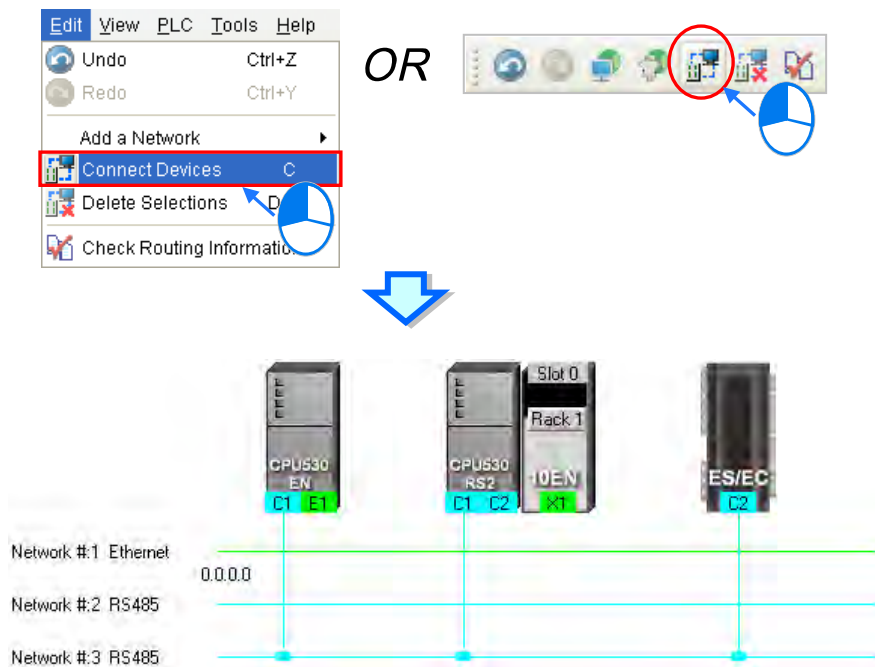

Additional remark

- If the devices selected do not conform to the principle described in (1), the system will not connect the devices selected to a new network, and a warning message will appear.
- If a device selected has more than one port which is not connected to any network and matches the new network added, the system will connect the port whose port number is smaller to the new network added.
- Users can select multiple devices by dragging a selection net around them. If the users press Ctrl+A on the keyboard, all the devices and networks in the working area are selected.
- If users select a node which consists of a PLC and a module, and the PLC and the module conform to the principle described in (1), the system will connect a port of the PLC and a port of the module to a new network added.
- If the devices that users select have ports which are not connected to any networks, and can be connected to an RS-485 network or an Ethernet network, the system will connect the ports to an Ethernet network.

9.2.3 Adjusting or Deleting Devices or Networks

- **Adjusting the order in which the nodes in the working area are arranged**

Users can change the order in which the nodes in the working area are arranged by dragging a node to a different position. The nodes in the working area can only be at the same level, and increase rightwards. The users can not drag a node to a position above or under another node.

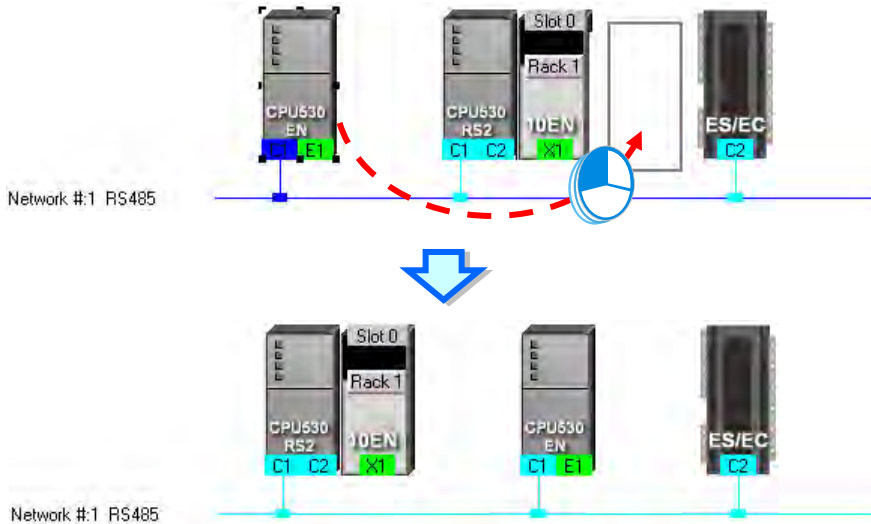

- **Deleting a single device by means of a context menu**

After users right-click a PLC, and click **Delete the Device** on the context menu, the PLC and the modules connected to the PLC will be deleted. However, the PLC for which a project is created and the modules connected to the PLC can not be deleted.

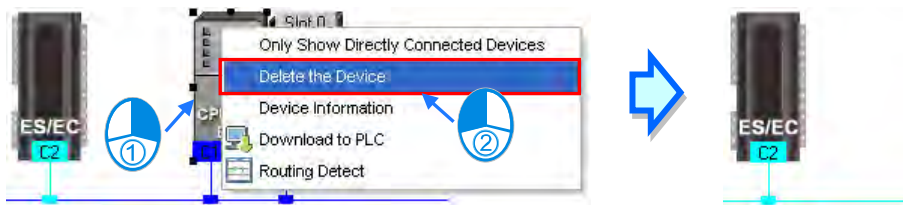

After the users right-click a module, and click **Delete the Module** on the context menu, the module will be deleted.

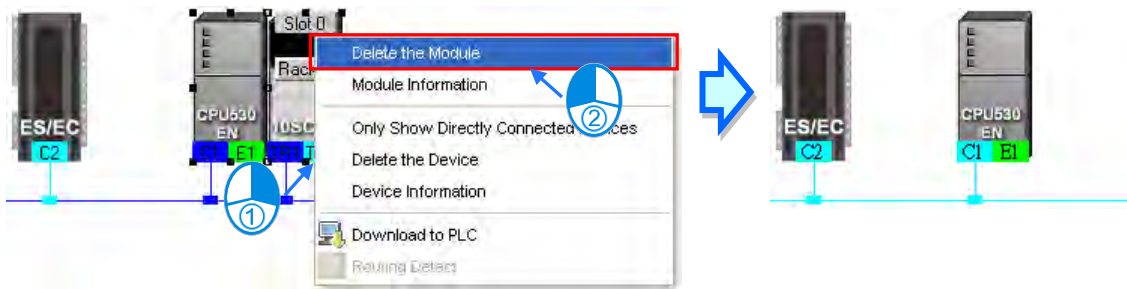

● **Adjusting a connection**

If users press the left mouse button while the mouse cursor hovers over a connection point which connects a network and a port, a small picture representing a trash can and a dotted line will appear.

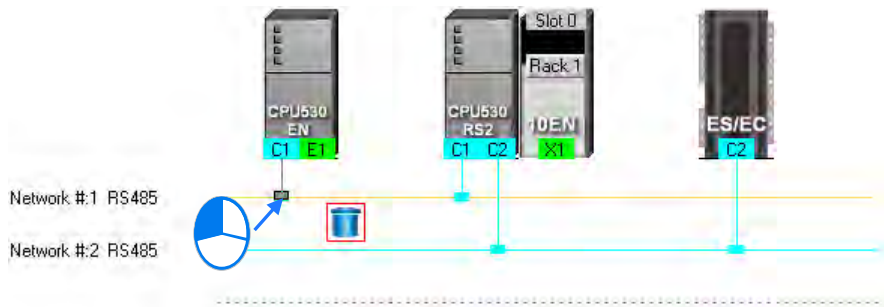

If the users release the left mouse button after they drag the connection point to the small picture representing a trash, the connection between the network and the port will be canceled.

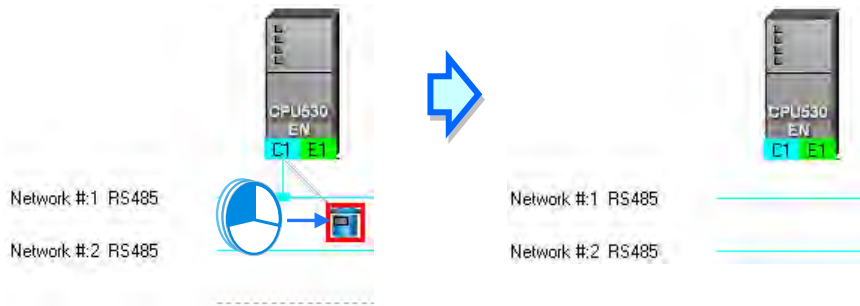

If the users drag the connection point to the dotted line, the system will connect the port to the new network added.

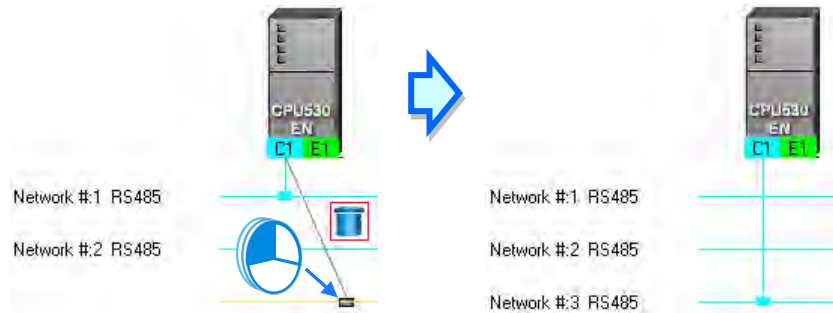

If the users release the left mouse button after they drag the connection point to another network which matches the port, the port will be connected to the network.

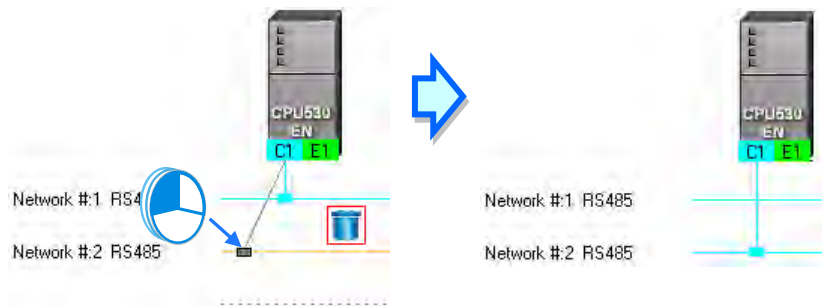

● **Deleting a single network by means of a context menu**

After users right-click a network, and click **Delete the Network** on the context menu, the network and the lines connected to the network will disappear.

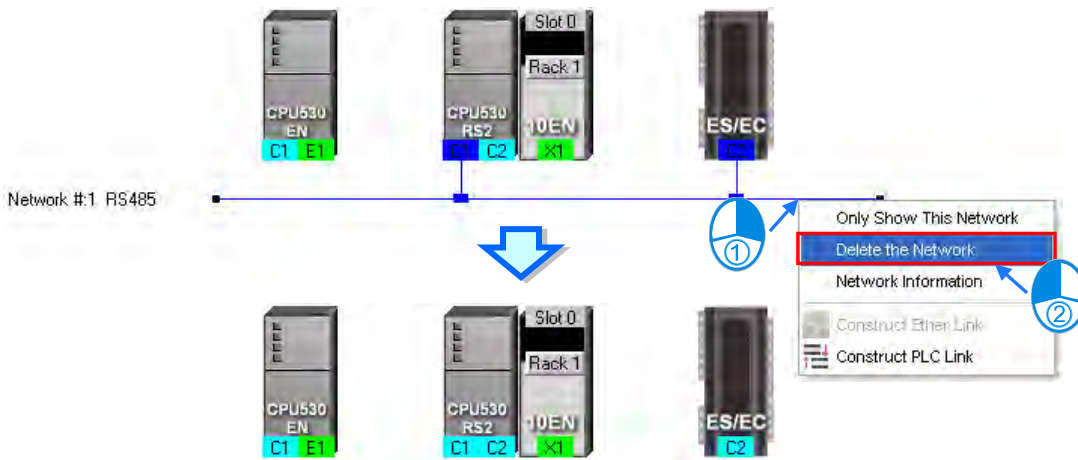

● **Deleting several devices or several networks**

Users can select several objects by holding down Shift on the keyboard. Besides, the users can select multiple devices by dragging a selection net around them, or selecting all the objects in the working area by pressing Ctrl+A on the keyboard.

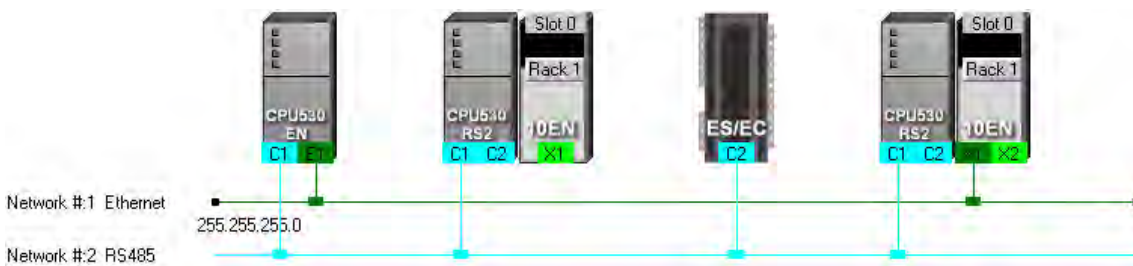

After the users click **Delete Selections** on the **Edit** menu, click  on the toolbar, or press Delete on the keyboard, the objects selected will be deleted. However, the PLC for which a project is created and the modules connected to the PLC can not be deleted. Besides, if a PLC is deleted, the modules connected to the PLC will also be deleted.

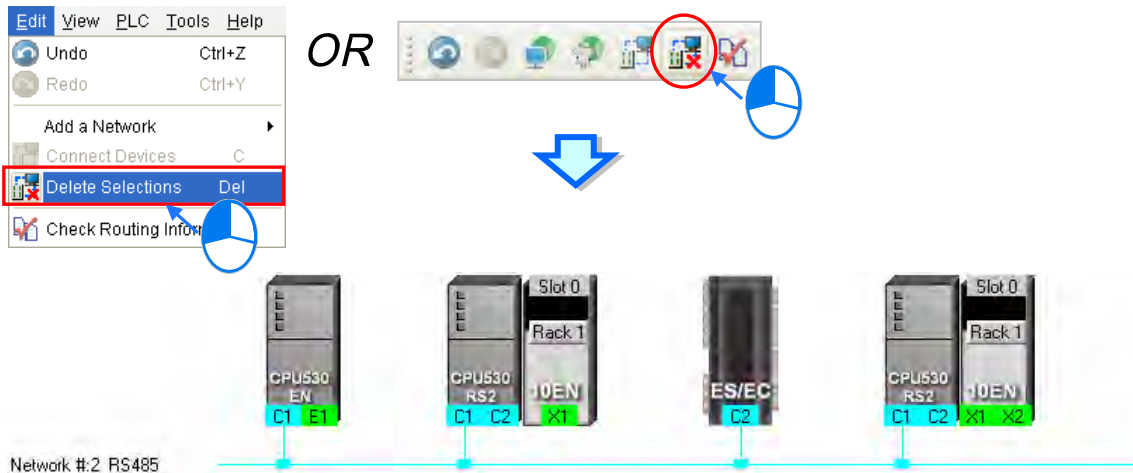

9

9.2.4 Setting the Attributes of a Node/Network

After users deploy the nodes in the NWCONFIG window, the information about the nodes will put above the nodes. The information includes PLC names and node numbers. The attributes of the ports connected to networks are also displayed. If a port is an RS-485 port, a station address will be displayed. If a port is an Ethernet port, an IP address will be displayed. The information about a port will be shown if the port is connected to a network. If a port is not connected to any network, no information about the port will be shown. Besides, if a port of a network module is connected to a network, the information about the slot in which the network module is installed, and the information about the backplane on which the network module is installed will be shown.

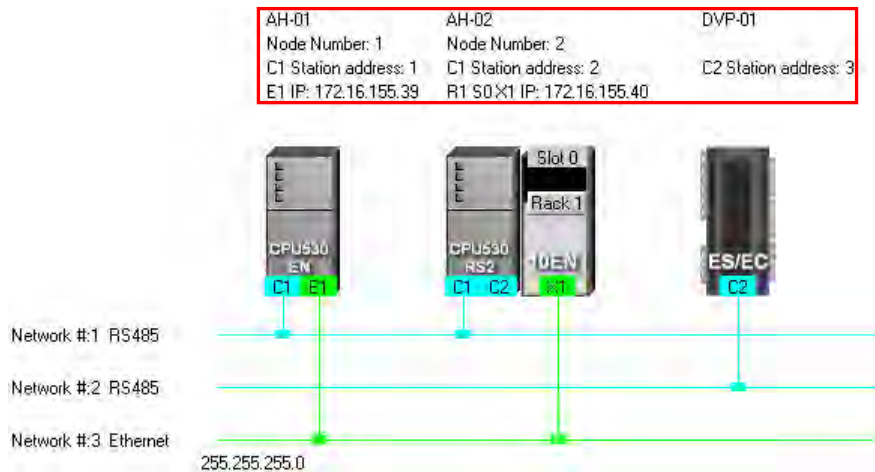

In addition to the information about the nodes, the network numbers assigned to the networks and the network types of the networks are shown. If a network is an Ethernet network, the subnet mask assigned to the ports connected to the network will be shown.

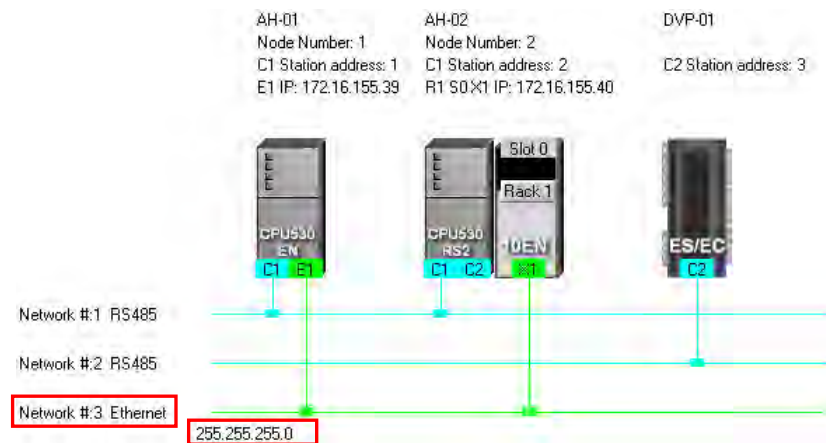

If the ports connected to an Ethernet network are not in the same domain, or are not assigned the same subnet mask, a warning sign will appear. If the ports connected to an Ethernet network are not assigned the same subnet mask, the strictest subnet mask will be shown.

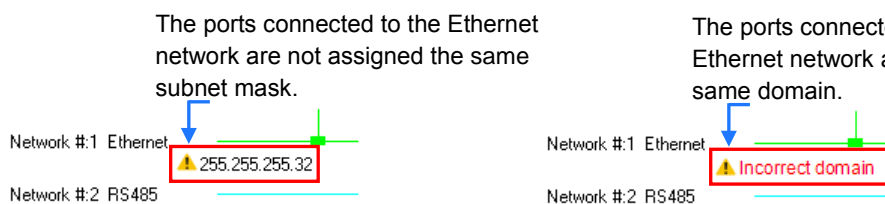

● **Setting the attributes of a node**

There are two ways to open the **Device Information** window.

- (a) After users double-click a PLC, the **Device Information** window will appear. The users can also open the **Device Information** window by right-clicking the PLC, and clicking **Device Information** on the context menu.
- (b) After users double click a module, the **Device Information** window will appear. The users can also open the **Device Information** window by right-clicking the module, and clicking **Module Information** on the context menu.



In the **Device Information** window, there are two tabs. The page displayed in the window depends on the device selected.

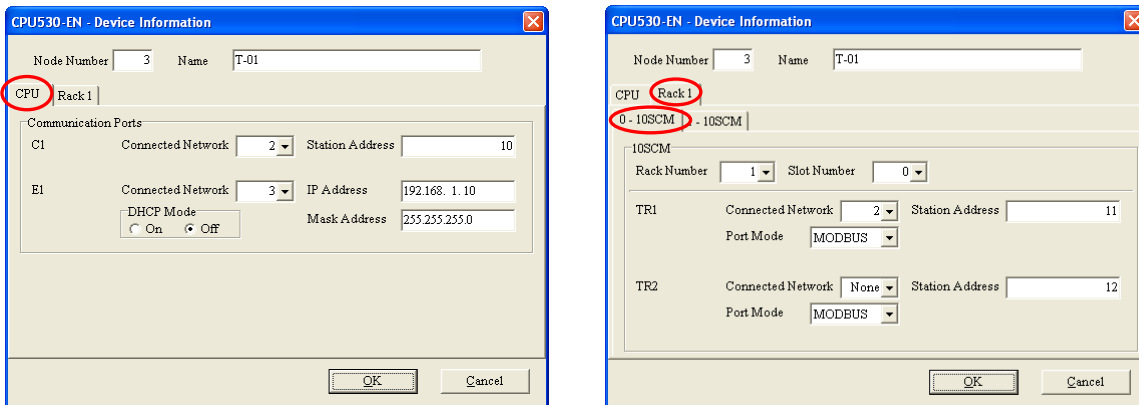

If the device selected is the AH500 series CPU module for which a project is created, or a module connected to the AH500 series CPU module for which a project is created, most boxes in the **Device**

Information window are gray. The attributes of the device can only be modified by means of HWCONFIG. If the device selected is a DVP series PLC, a device which is added to the working area, the users can set the attributes of the device. Please refer to section 9.1.2 for more information about the meaning of attributes.

In the **Device Information** window, a port is related to a **Connected Network** drop-down list box. If a port can be connected to several networks, the network numbers assigned to these networks will be on the drop-down list which appears after the users click  in the **Connected Network** drop-down list box related to the port. The users can select a network number on the drop-down list. If **None** is selected, the port will not connect to any network. This function is similar to the adjustment of a connection described in section 9.2.3.

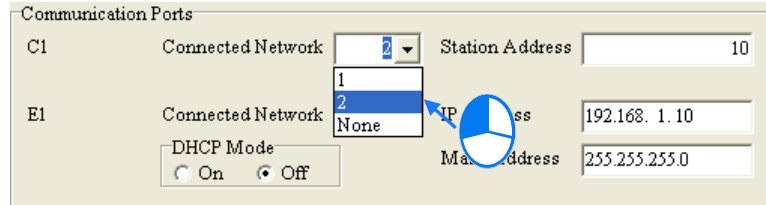

In the page for a module, the users can select a rack number in the **Rack Number** drop-down list box, and a slot number in the **Slot Number** drop-down list box.

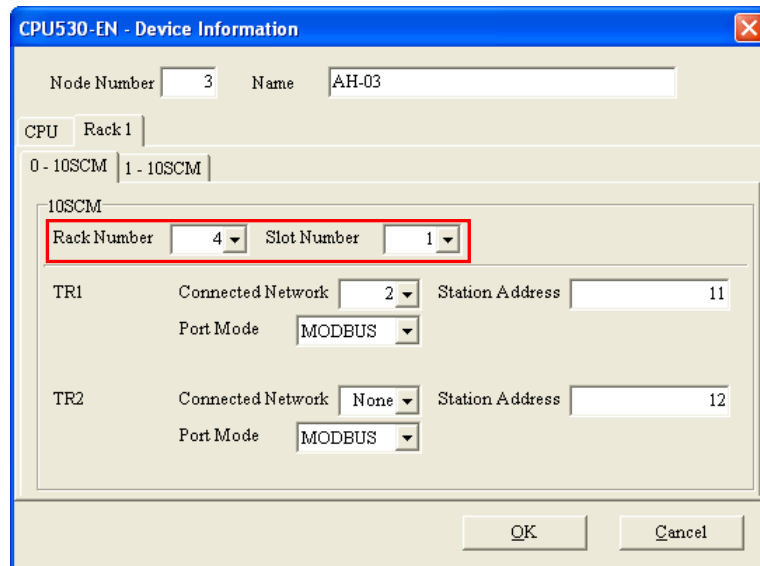

After the users complete the setting of the attributes of a node, and click **OK** in the **Device Information** window, the attributes of the node will be updated immediately.



● **Setting the attributes of a network**

After users double-click a network, the **Network Information** window will appear. The users can also open the **Network Information** window by right-clicking the network, and clicking **Network Information** on the context menu.

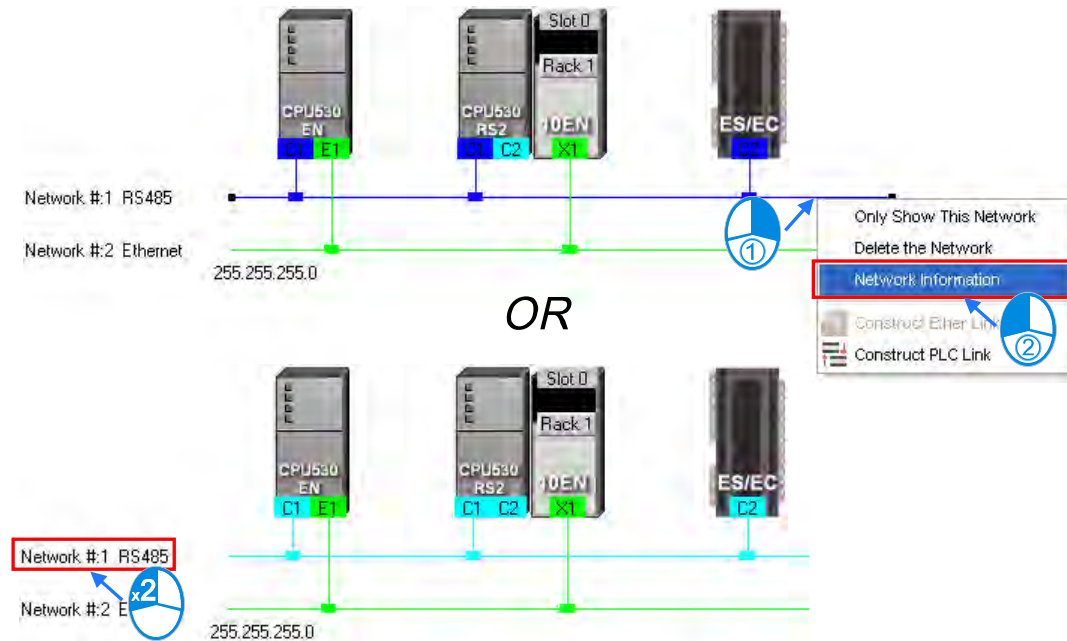

In the **Network Information** window, the users can select a network number which is not assigned to any network in the **Network Number** drop-down list box. Besides, the users can type a comment in the **Comment** box. After the users complete the setting of the attributes of the network, and click **OK** in the **Network Information** window, the attributes of the network will be updated immediately.

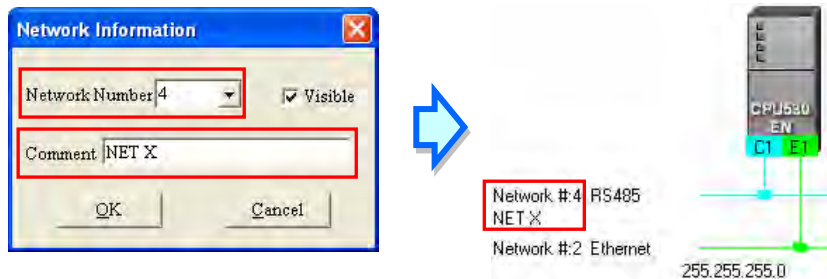

If the users unselect the **Visible** checkbox in the **Network Information** box, the network and the devices connected to the network will become invisible, the other devices connected to the other networks will still be displayed, and the lines connected to the network will become dotted lines. Please refer to section 9.2.5 for more information about hiding/displaying devices or networks.

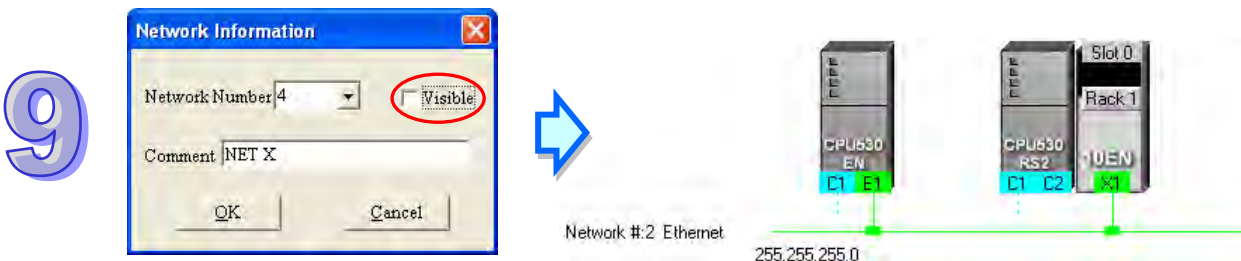

9

9.2.5 Hiding/Displaying Devices or Networks

Users can hide/display devices or networks in the working area. The number of devices visible and the total number of devices are displayed in the status bar. Besides, if a dotted line is connected to a port of a device, the port is connected to an invisible network.

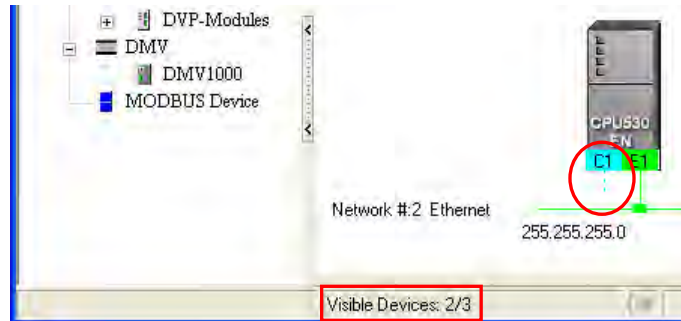

- **Only displaying the objects connected to a device**

After users right-click a node, and click **Only Show Directly Connected Devices** on the context menu, only the network and the devices which are connected to the node will be displayed.

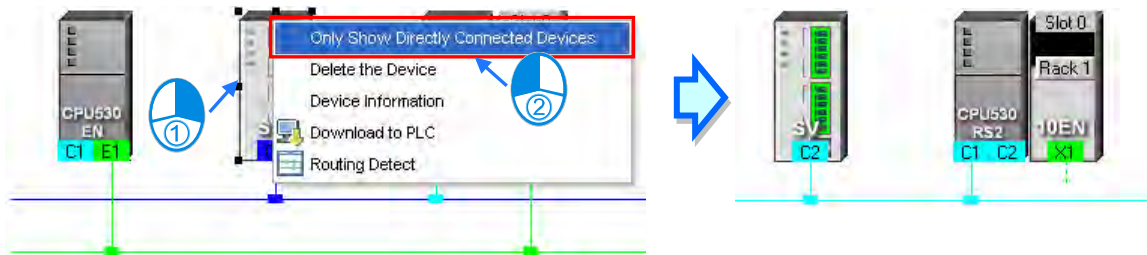

- **Only displaying the devices connected to a network**

After users right-click a network, and click **Only Show This Network** on the context menu, only the devices connected to the network will be displayed.

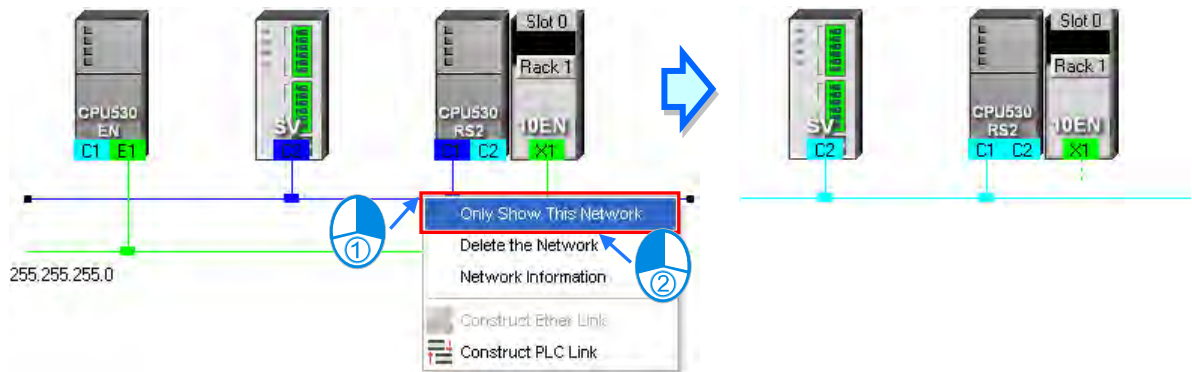

● **Hiding a network and the devices connected to the network**

After users unselect the **Visible** checkbox in the **Network Information** box, the network and the devices connected to the network will become invisible, but the other devices connected to the other networks will still be displayed,

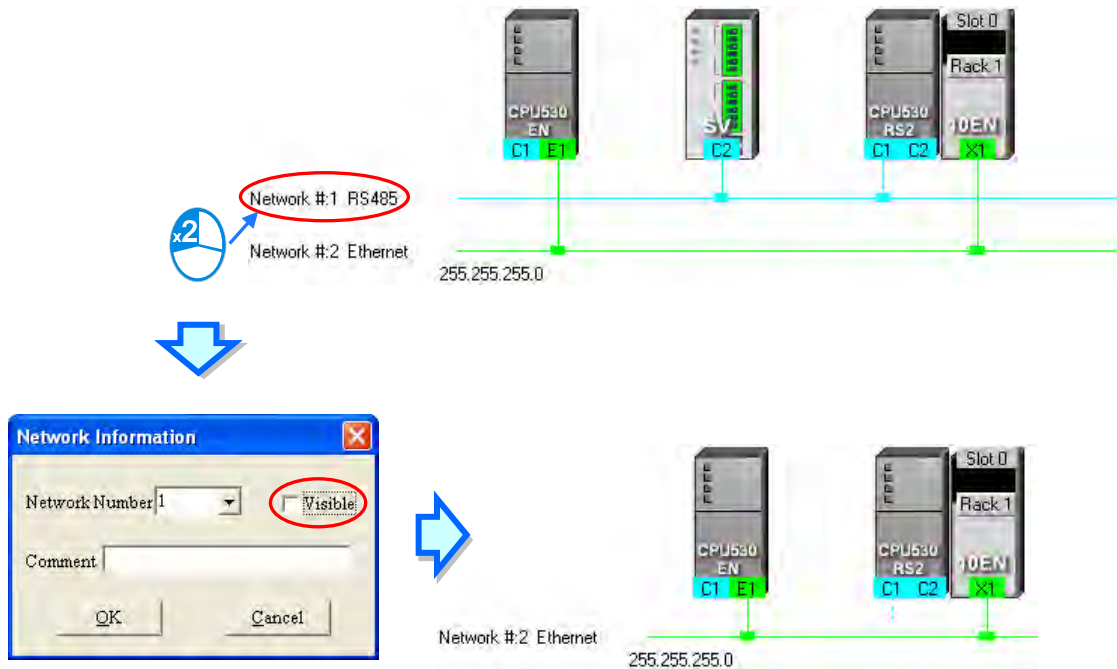

● **Hiding/Displaying the devices which are not connected to any networks**

If users want to hide/display the devices which are not connected to any networks, they can right-click the working area, point to **Unconnected Devices Visible** on the context menu, and click **Hide/Show**. This operation affects the devices in the present working area. It does not affect the devices which will be added latter.

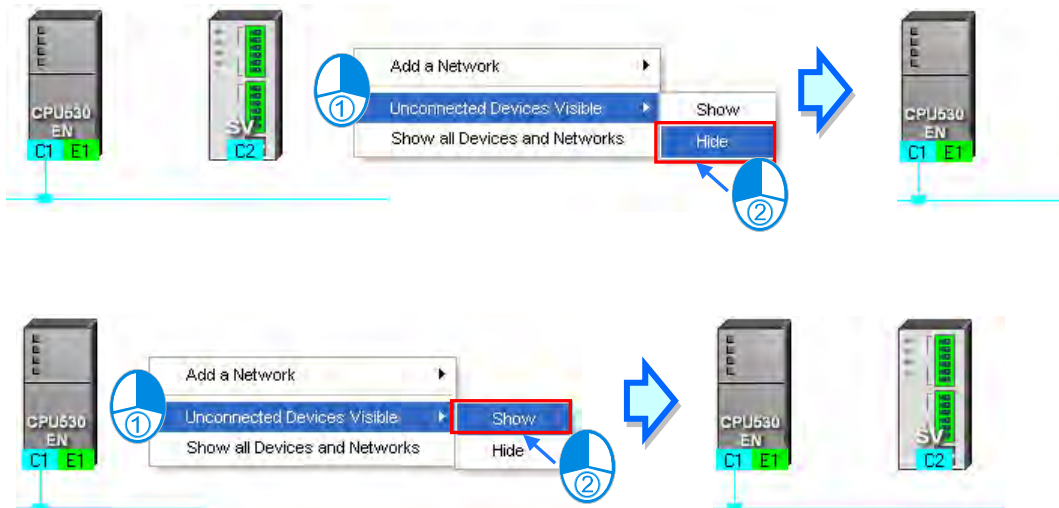

9

● **Setting the display states of all the objects at the same time**

Users can set the display states of all the devices at the same time. Click **Device & Network Visible Settings** on the **View** Menu, or  on the toolbar.



Select networks which will be displayed in the **Networks** section in the **Devices & Networks Visible Settings** window. The networks which are not selected will not be displayed in the working area. If the users select the **Select All** checkbox, all the networks in the **Networks** section will be selected. If the users unselect the **Select All** checkbox, all the networks in the **Networks** section will be unselected. In the **Unconnected Devices** section, the users can set the display states of the devices which are not connected to any networks. This operation affects the devices in the present working area. It does not affect the devices which will be added latter.

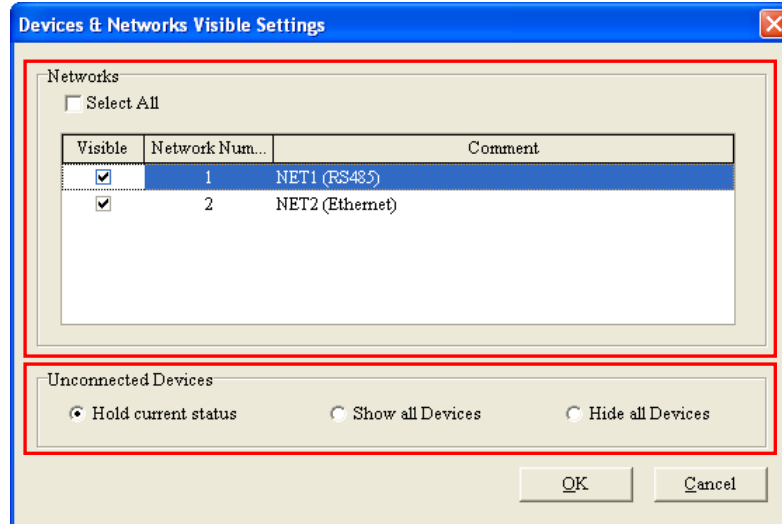

- **Displaying all the objects**

After users right-click the blank in the working area, click **Show All Devices and Networks** on the context menu, the devices and the networks which are hidden will be displayed.

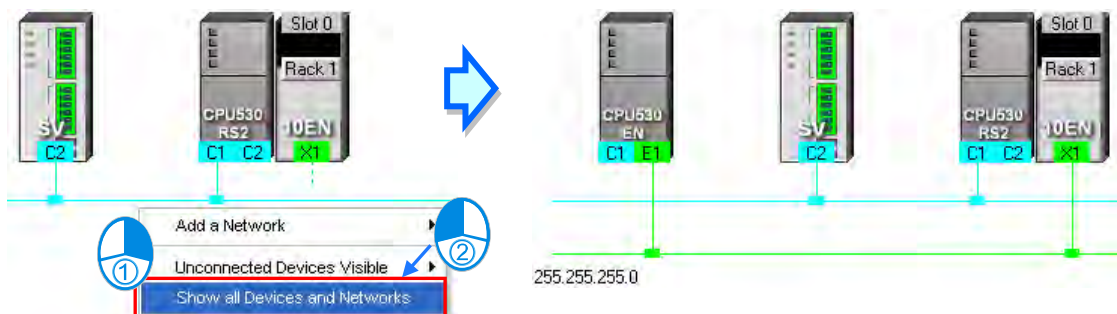

9.2.6 Correct Network Architecture

After users click **Check Routing Information** on the **Edit** menu, or  on the toolbar, the system will check whether the network architecture the users create is correct, and the check result will be displayed in the message display area.

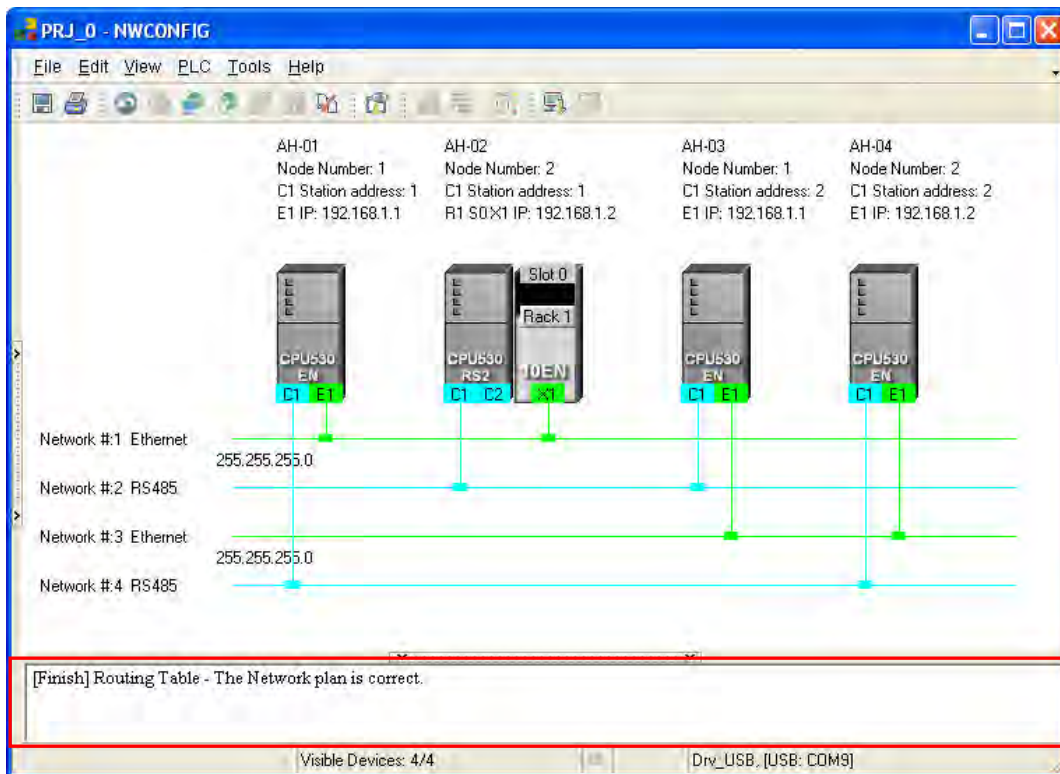
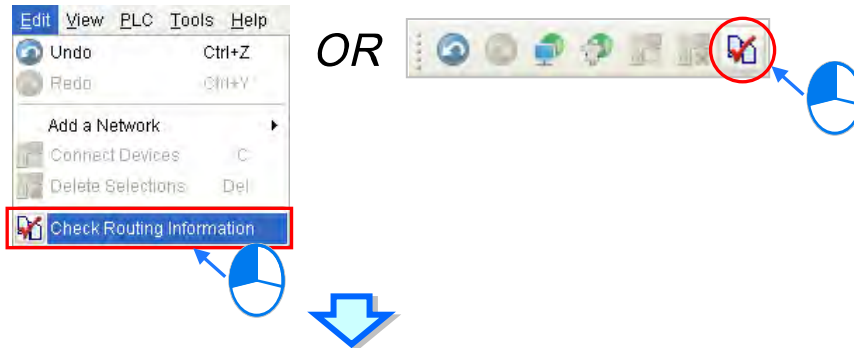

9

The system checks the ports which are connected to networks. It checks whether the information about the nodes and the information about the networks are correct. Specifically, it checks the node numbers, the RS-485 station addresses, and the IP addresses in the working area. At first glance, the network architecture in the figure above seems to be incorrect in that the node number assigned to AH-01 is the same as the node number assigned to AH-03, the node number assigned to AH-02 is the same as the node number assigned to AH-04, the RS-485 station address assigned to AH-01 is the same as the RS-485 station address assigned to AH-02, the RS-485 station address assigned to AH-03 is the same as the RS-485 station address assigned to AH-04, the IP address assigned to AH-01 is the same as the IP address assigned to AH-03, and the IP address assigned to AH-02 is the same as the IP address assigned to AH-04. The users can view a network at a time by means of a skill introduced in section 9.2.5. The users have to make sure that the node number, the RS-485 station address, and the IP address which are assigned to a node are not the same as the node number, the RS-485 station address, and the IP address which are assigned to another node. The message in the message display area in the figure above indicates that the network architecture in the working area is correct.

● **Node number**

In principle, the node number assigned to a node in a network can not be the same as the node number assigned to another node in the network. If users view a network at a time, they can check whether the node number assigned to a node connected to a network is the same as the node number assigned to another node connected to the network.

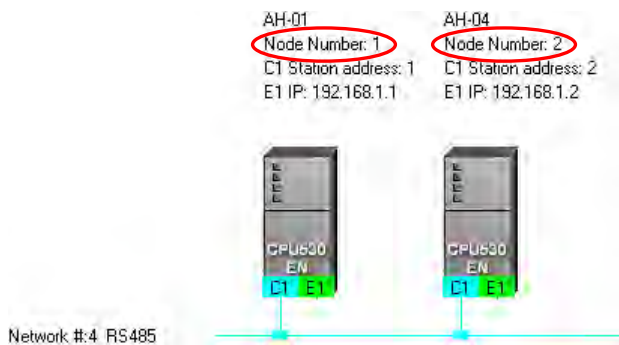
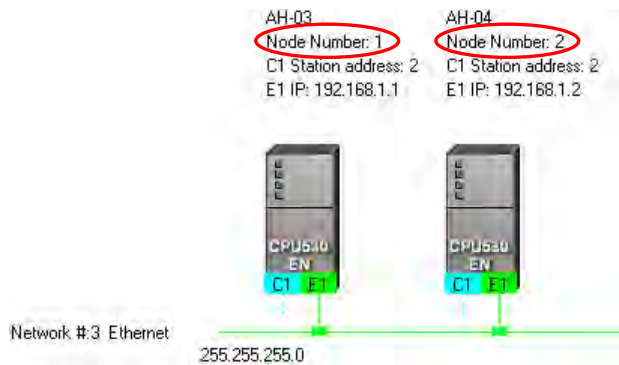
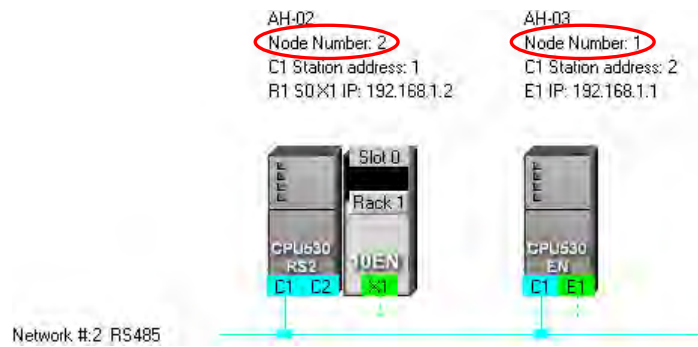
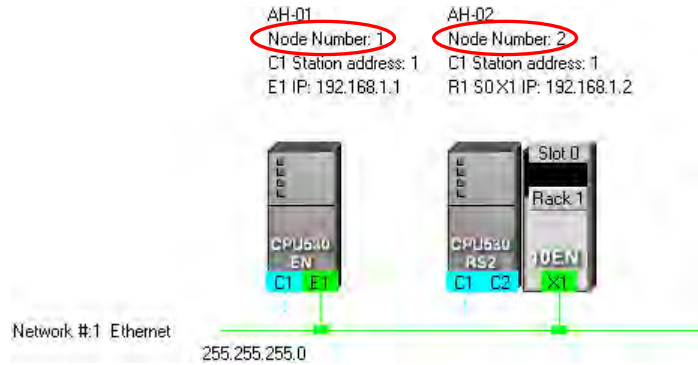

● **RS-485 station address**

In principle, the RS-485 station address of a port in a network can not be the same as the RS-485 station address of another port in the network. If users view an RS-485 network at a time, they can check whether the RS-485 station address of a port in a network is the same as the RS-485 station address of another port in the network.

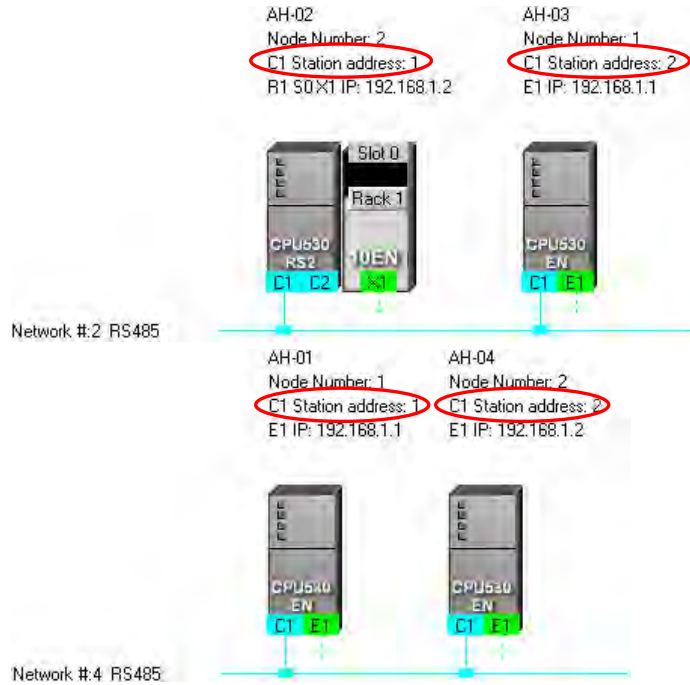

● **IP address**

The IP address of a port in a network can not be the same as the IP address of another port in the network. If users view an Ethernet network at a time, they can check whether the IP address of a port in a network is the same as the IP address of another port in the network.

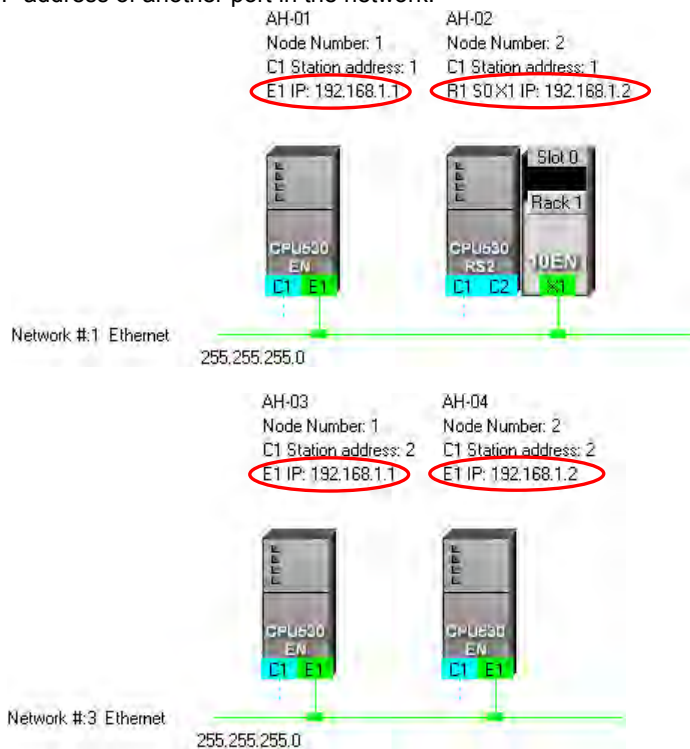

9.2.7 Downloading Routing Tables

After users make sure that the network architecture they create is correct, they can download the routing tables produced to PLCs. The routing data stored in a PLC is data related to the PLC itself, and therefore the routing tables downloaded to nodes are different. The users have to download the routing tables produced to nodes in the working area.

The users can download the routing tables produced to nodes one by one, or download the routing tables produced to nodes at the same time. If the users want to download the routing tables produced to nodes, the **Routing Mode** checkbox in the **Select a Driver** window must be unselected. Please refer to section 9.1.3 for more information.

- **Single node**

The users have to select a node in the working area. Only AH500 series CPU modules support routing. If the users select a device which is not an AH500 series CPU module, a routing table can not be downloaded to the device.

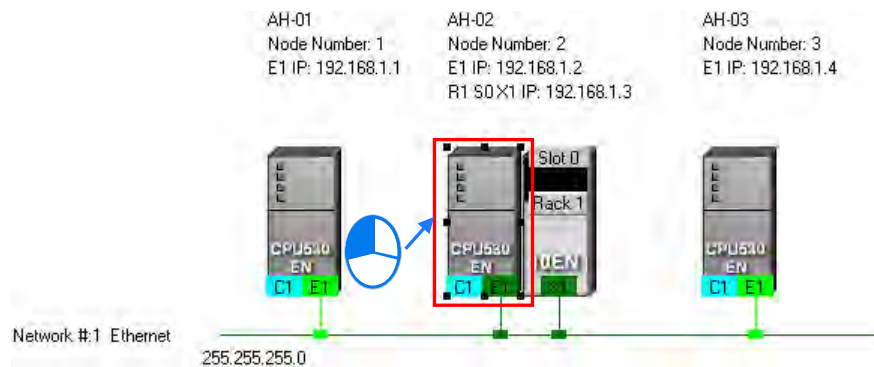

After the users click **Download to PLC** on the **PLC** menu, or  on the toolbar, the **Optional Download** window will appear. The users can also open the **Optional Download** window by right-clicking the device they select, and clicking **Download to PLC** on the context menu. After the users select the **Routing Table** checkbox in the **Optional Download** window, and click **OK**, a routing table will be downloaded to the device.

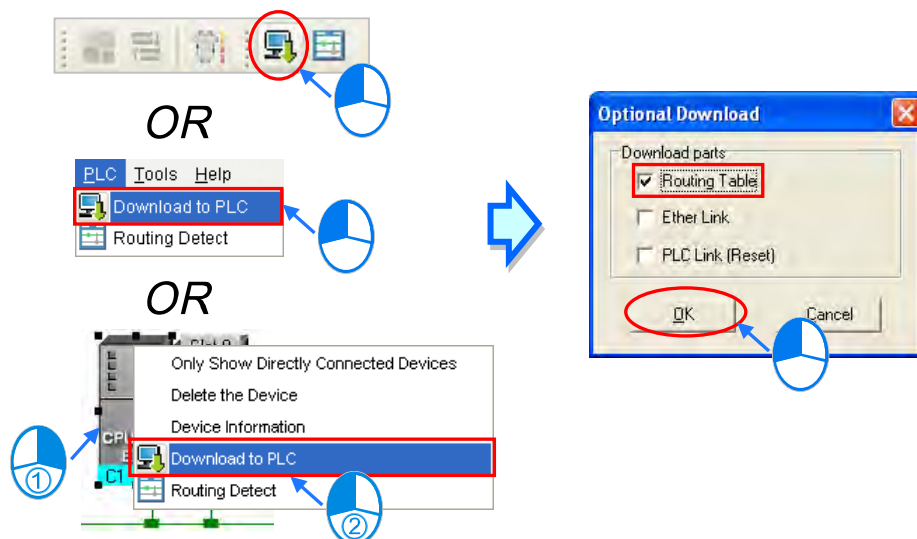

- **Multiple nodes**

The users have to select an Ethernet network in the working area. If the actual connection is consistent with the setting in NWCONFIG, parameters can be downloaded to the nodes connected to the Ethernet network. If the users want to download the routing tables produced to multiple devices connected to the Ethernet network, the connection type that the driver selected in the **Driver Name** drop-down list box in the

Select a Driver window uses must be Ethernet. Please refer to section 9.1.3 for more information.

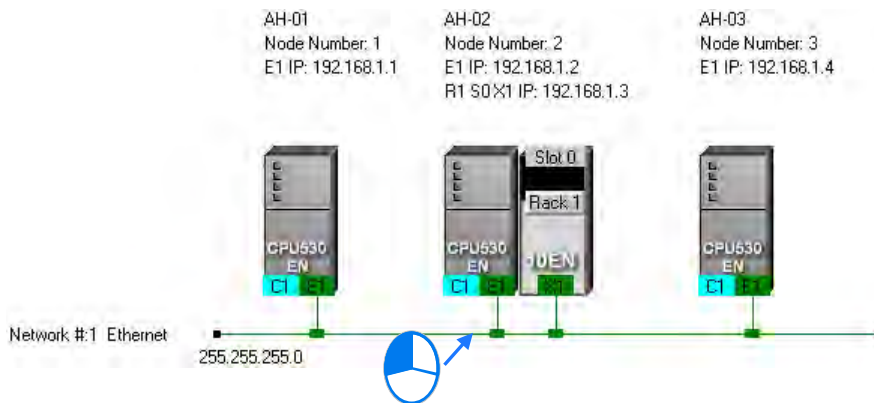

After the users click **Download to PLC** on the **PLC** menu, or  on the toolbar, the **Optional Download** window will appear. After the users select the **Routing Table** checkbox in the **Optional Download** window, and click **OK**, the routing tables produced will be downloaded to the nodes connected to the Ethernet network.

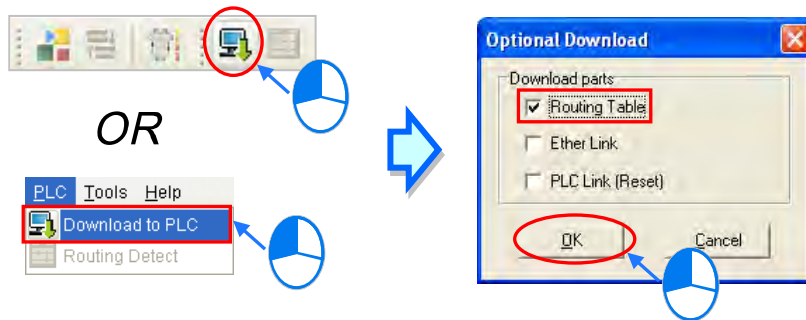

Additional remark

If the parameters related to an Ether Link or a PLC Link can be downloaded to the object selected, users can select the **Ether Link** checkbox or the **PLC Link (Reset)** checkbox in the **Optional Download** window. If a checkbox in the **Optional Download** window is gray, the checkbox can not be selected. Please refer to the following sections for more information about Ether Links and PLC Links. Besides, the routing data stored in a PLC is data related to the PLC itself. The users can not upload the routing data stored in a PLC. The system does not provide the function of uploading routing data.

9.2.8 Testing Routing

After the routing tables produced are downloaded, users can test routing by means of a function provided by NWCONFIG. The steps of testing routing are as follows.

- (1) The users have to make sure that all the nodes are wired according to the configuration in NWCONFIG, and operate normally. The setting of the devices has to be consistent with the setting in NWOCNIFG. In the **Select a Driver** window, the users have to select the **Routing Mode** checkbox, and select a device in the **First Station** drop-down list box. Please refer to section 9.1.3 for more information about setting communication.

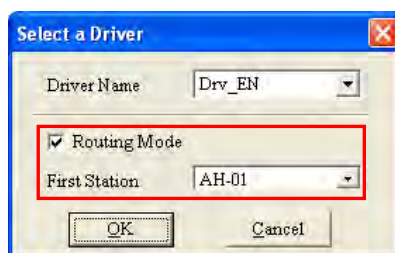

- (2) After the users select the destination device toward which packets are relayed, they have to click  on the toolbar, or **Routing Detect** on the **PLC** menu.

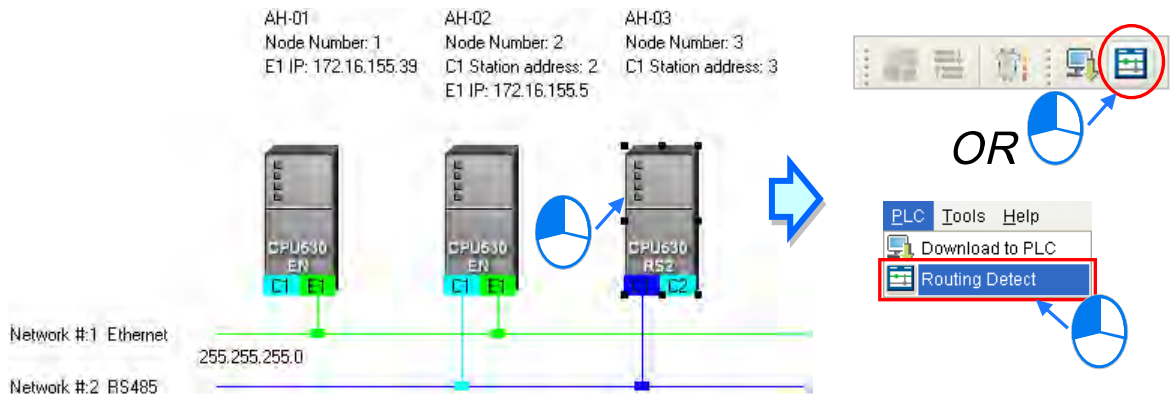

The users can also right-click the destination device, and then click **Routing Detect** on the context menu.

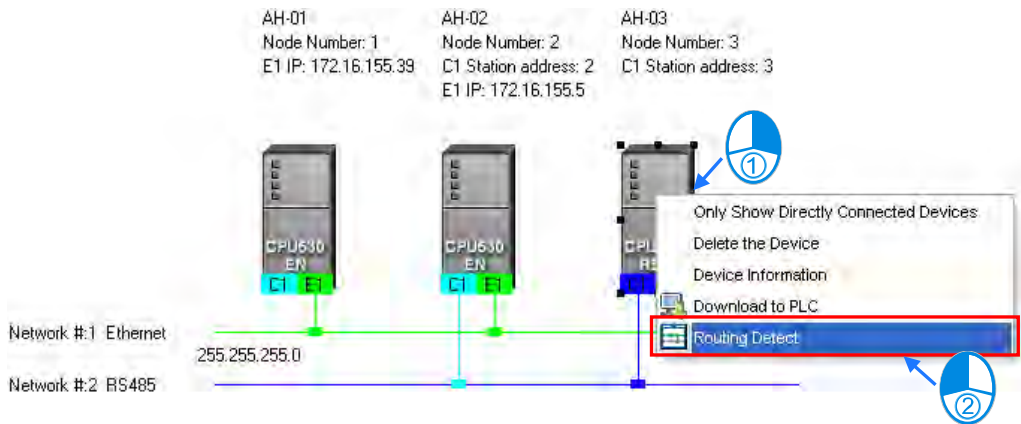

- (3) After **Routing Detect** is clicked, the display of the network architecture in the working area will change, and the **Routing detect status** window will appear. The way in which the node which is designated as the first station is connected to the computer is also shown in the working area. Please see the red circle in the figure below.

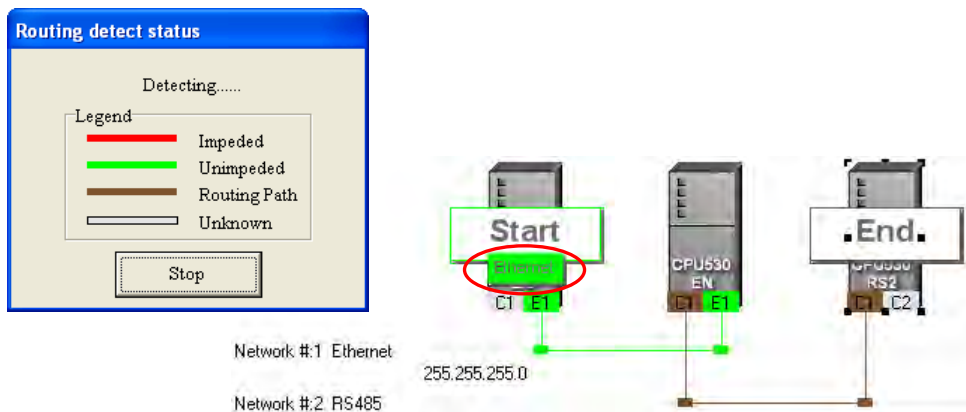

(4) After the detection is complete, the detection result will be shown in the working area.

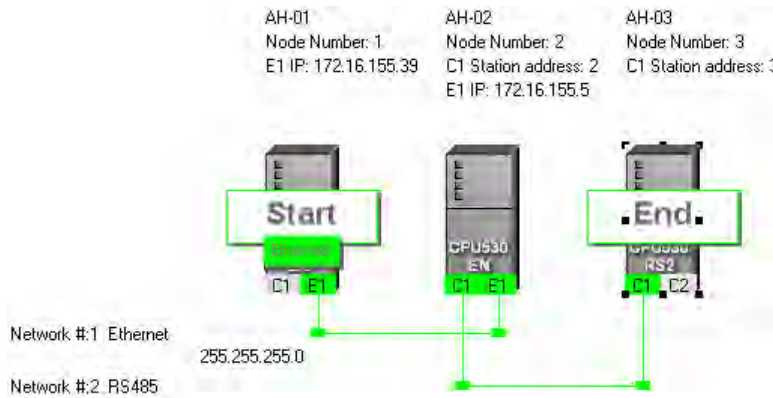

Additional remark

If the detection fails, the users have to make sure of the following points.

- (a) The users have to make sure that the IP addresses and the station addresses which are assigned to the devices and the communication setting in the devices are consistent with the setting in NWCONFIG. If AH500 series CPU modules or AH500 series modules are used, the users have to make sure that the parameters in the AH500 series CPU modules in HWCONFIG or the parameters in the AH500 series modules in HWCONFIG are set correctly, and downloaded to the AH500 series CPU modules or the AH500 series modules successfully. If DVP series PLCs or DVP series modules are used, the users have to make sure that the communication parameters in the related registers are correct. If other devices are used, the users have to refer to manuals for the usage of these devices, and make sure that the communication parameters in these devices are correct.
- (b) The users have to make sure that all the network connection is consistent with the setting in NWCONFIG. They also have to make sure that every node is connected to a network correctly, and operates normally.
- (c) Please refer to section 9.1.3, and make sure that the communication setting is correct.

9.3 Managing and Applying NWCONFIG

9.3.1 Saving Parameters and Printing a Network Framework

If users want to save the parameters set in NWCONFIG, they can click **Save** on the **File** menu, or  on the toolbar. The parameters which can be saved are the network framework created in NWCONFIG, the parameters related to the PLC Links constructed, and the parameters related to the Ether Links constructed. After the saving of the parameters set in NWCONFIG is complete, an nw file whose primary filename is the project name/group name, and an nwsd file whose primary filename is the project name/group name will appear in the folder in which the project/group of projects is/are saved.



After the users click **Print Preview** on the **File** menu, or  on the toolbar, the system will automatically open the **Print Preview** window, and the network framework that the users create in NWCONFIG will be displayed in the **Print Preview** window. Please refer to appendix C for more information.

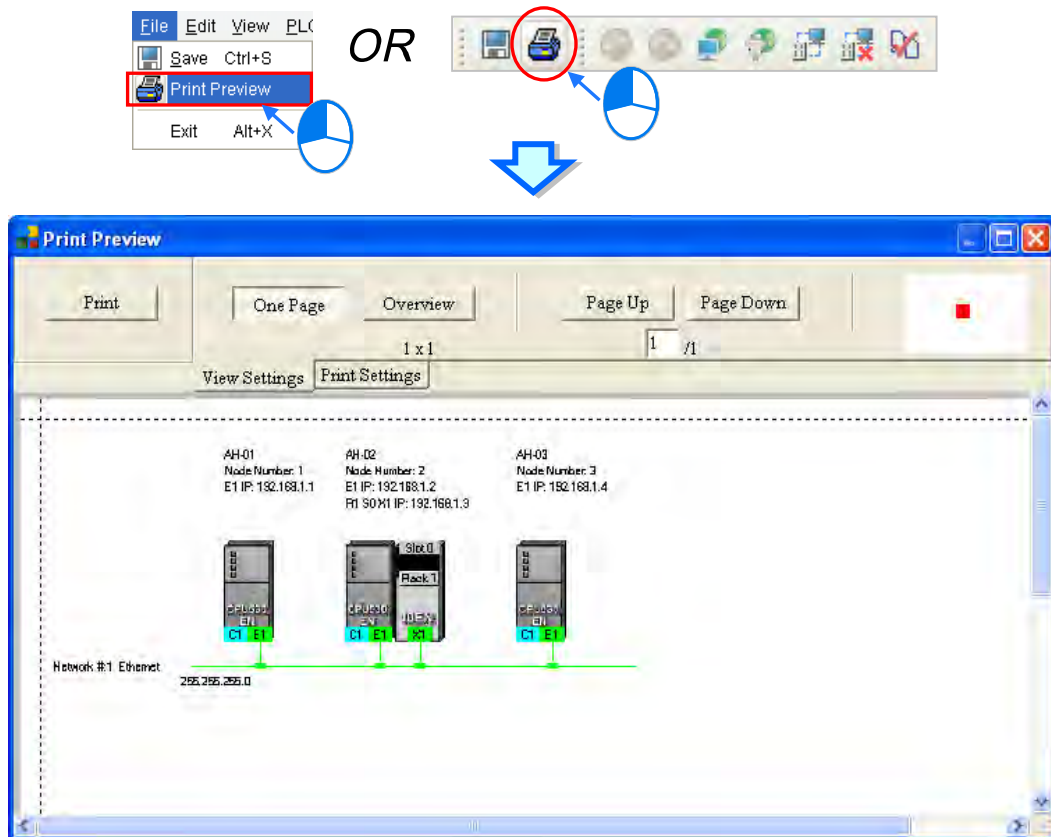

Before the users print the data related to a PLC Link or an Ether Link, they have to export the data as a CSV file. After the CSV file is opened in Microsoft Excel, they can print the data in the CSV file.

9.3.2 Downloading Parameters

In the working area in NWCONFIG, users can download the routing tables produced to PLCs, the parameters related to the PLC Links constructed, and the parameters related to the Ether Links constructed to the nodes. The users have to download the routing tables produced to nodes in the working area.

9.3.2.1 Introduction of Parameters

- **Routing table**
The routing data stored in a PLC is data related to the PLC itself, and therefore the routing tables downloaded to nodes are different.
- **Parameters related to a PLC Link**
The parameters related to a PLC Link can only be downloaded to the PLC designated as a master station. If the parameters related to a PLC Link are downloaded to a slave station, the related special relays and the related special registers in the slave station will be restored to the default setting. There is only one master station in a network. If users are not sure whether a device was designated as a master station, and whether the parameters related to a PLC Link was downloaded to the device, they have to download the parameters related to a PLC Link to the device.
- **Parameters related to an Ether Link**
The parameters related to an Ether Link must be downloaded to the data demanding nodes. However, the data exchange table stored in a PLC is a table related to the PLC itself. Besides, if the parameters set include a node which does not demand any data, the data in the node will be cleared after the parameter are downloaded to the node, and the start mode of the node will depend on the parameters after the

parameters are downloaded to the node.

9.3.2.2 Description of Downloading Parameters

If the users want to download parameters, the **Routing Mode** checkbox in the **Select a Driver** window must be unselected. Please refer to section 9.1.3 for more information.

- **Single node**

The users have to select a node in the working area.

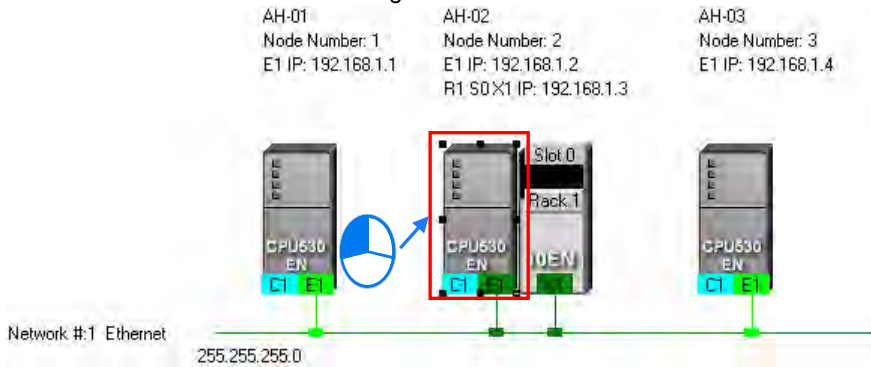

After the users click **Download to PLC** on the **PLC** menu, or  on the toolbar, the **Optional Download** window will appear. The users can also open the **Optional Download** window by right-clicking the device they select, and clicking **Download to PLC** on the context menu.

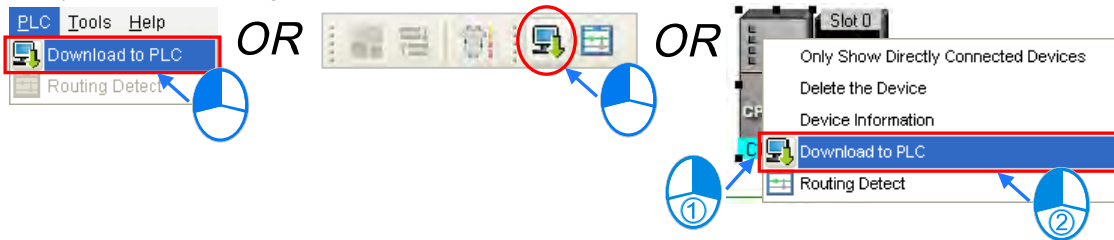

- **Multiple nodes**

The users have to select an Ethernet network in the working area. After the users click **Download to PLC** on the **PLC** menu, or  on the toolbar, the **Optional Download** window will appear. If the actual connection is consistent with the setting in NWCONFIG, parameters can be downloaded to the nodes connected to the Ethernet network.

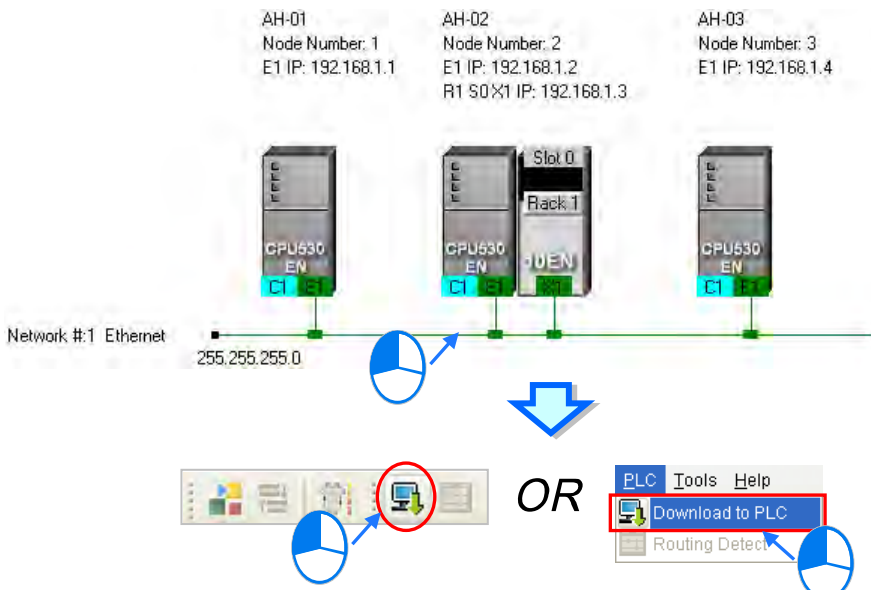

9

After the users follow the steps described above, the **Optional Download** window will appear. If a checkbox in the **Optional Download** window is gray, the checkbox can not be selected. After the users select checkboxes in the **Optional Download** window, they can click **OK**.

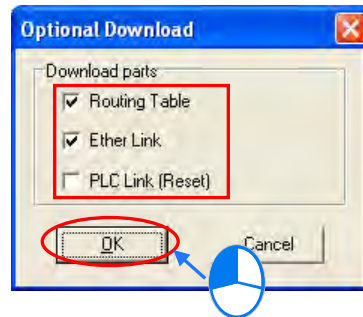

9.3.3 Using Routing in ISPSOft

After users create a network architecture in NWCONFIG, and download the routing tables produced to PLCs, they can download data to a device which is not directly connected to ISPSOft through routing, upload data from a device which is not directly connected to ISPSOft through routing, or monitor data in a device which is not directly connected to ISPSOft through routing. If the users want to use routing in ISPSOft, the devices used must be AH500 series CPU modules.

In the figure below, the PLC which actually connects to the computer is AH-01. AH-03 can be monitored through routing.

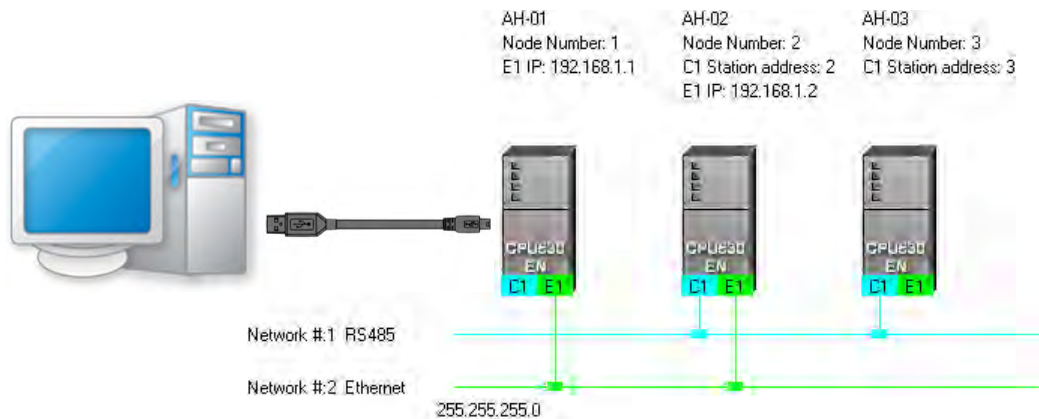

- (1) Users have to activate the project for AH-03.

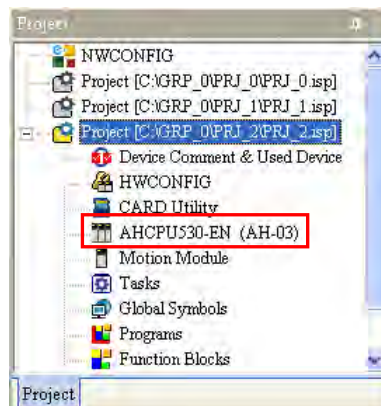

- (2) Click the **Tools** menu, and then click **Communication Settings....**

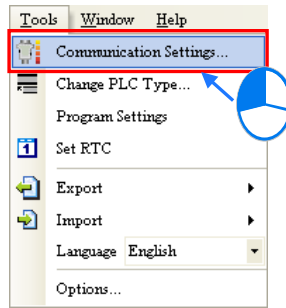

- (3) In the **Communication Setting** window, the users have to select the **Routing Mode** checkbox, and select a device in the **First Station** drop-down list box.

Generally speaking, the device which actually connects to the computer is the first station. If the computer connects to several devices, or connect to devices through Ethernet, the users have to designate a device as the first station according to the network framework created in NWCONFIG. Besides, if the **Routing Mode** checkbox is selected, the driver selected in the **Driver** drop-down list box must be a driver which can connect to the first station.

After the users click **OK** in the **Communication Setting** window, AH-03 can be monitored through AH-01.

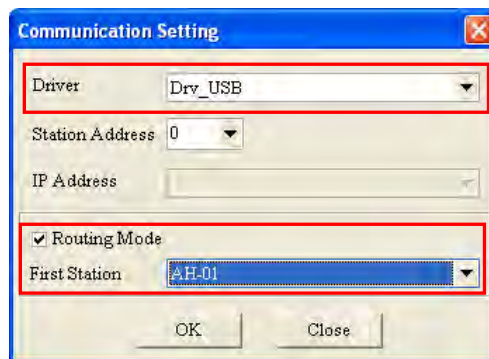

Additional remark

Before users use routing, they have to create projects, configure hardware, and configure a network. Please refer to section 9.1.4 for more information. The users can also refer to section 9.1.3 for more information about the communication setting in NWCONFIG.

Chapter 10 Operating Principle of the CPU Module

Table of Contents

10.1	Operation of the CPU Module	10-2
10.1.1	Procedure	10-2
10.1.2	I/O Refreshing and Communication Service	10-3
10.2	Operating Modes of the CPU Module	10-3
10.2.1	Operating Modes.....	10-3
10.2.2	Statuses and Operation under Different Operating Modes.....	10-3

10.1 Operation of the CPU Module

10.1.1 Procedure

The operation of the CPU module is described below.

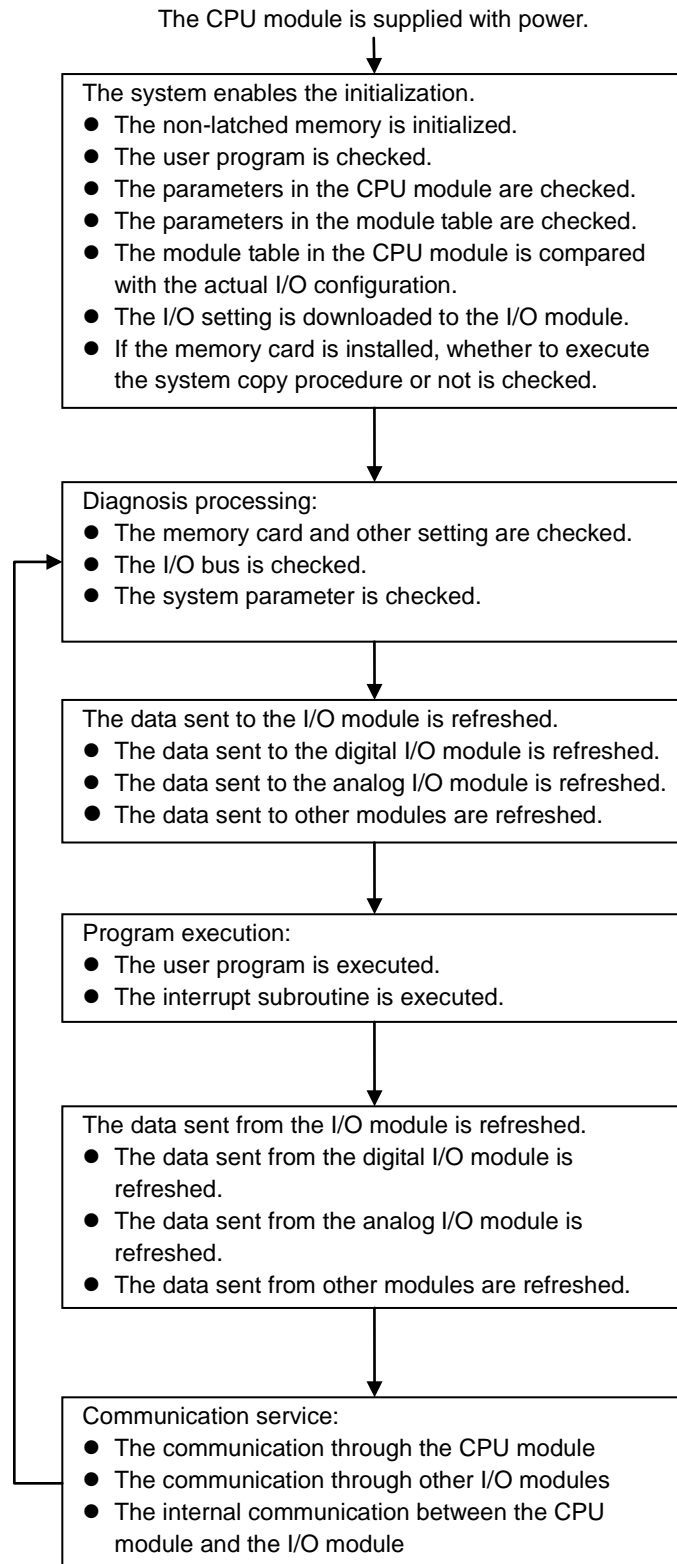

10.1.2 I/O Refreshing and Communication Service

- **I/O refreshing**

A CPU module reads external I/O data periodically or output data to external I/O. I/O refreshing includes the following.

- Refreshing data in a digital I/O module
- Refreshing data in an analog I/O module
- Refreshing data in a network module
- Refreshing data in a motion control module

All I/O refreshing is executed in the same loop. The data in an input device is refreshed before a program is executed, and the data in an output device is refreshed after the program is executed.

Unit	Maximum data exchange	Data exchange area
Digital I/O module	It depends on the number of input/output channels in the unit.	Input relay/Output relay
Analog I/O module	It depends on the number of input/output channels in the unit.	Data register
Network module	It depends on the unit.	Data register
Motion control module	It depends on the unit.	Data register

- **Communication service**

Communication service is nonscheduled communication service of a network module. It includes the communication request sent from external equipment to a CPU module, and the communication request sent from the CPU module to the external equipment.

10.2 Operating Modes of the CPU Module

10.2.1 Operating Modes

There are two operating modes. They can be used to control a user program and all tasks.

STOP mode: A program is not executed under this mode. Users can download a module table, initialize CPU configuration and other setting, download a program, check a program, and force a bit ON/OFF.

RUN mode: A program is executed under this mode. Users can not download a module table, and initialize CPU configuration and other setting.

10.2.2 Statuses and Operation under Different Operating Modes

The STOP mode and the RUN mode are modes for a CPU module. The statuses and operation under these modes are listed below.

- **Basic operation**

CPU mode	Program	I/O refreshing	External output	Program memory	
				Non-latched area	Latched area
STOP	The execution of the program stops.	The I/O refreshing is executed.	OFF (If users set the I/O module so that the final state of the external output on the I/O module is retained, the final state of the external output on the I/O module will be retained.)	The data in the program memories are retained.	
RUN	The program is executed.	The I/O refreshing is executed.	The external output is controlled by the program.	The program memories are controlled by the program.	

● **Relation between the operating modes and the tasks**

Mode	Loop task	Interrupt task
STOP	The execution of the loop task stops.	The execution of the interrupt task stops.
RUN	<ul style="list-style-type: none"> ● The tasks which have not been executed are in the halt state. ● If a task is active, or the instruction TKON is executed, the task is executed. ● If a task is not active, or the instruction TKOFF is executed, the task is not executed. 	If the condition of the interrupt is met, the task is executed.

● **Relation between the change of the modes and the program memory**

Change of the mode	Non-latched area	Latched area
STOP→RUN	Whether the data is cleared or retained depends on user's setting.	The data is retained.
RUN→STOP	The data is retained.	The data is retained.

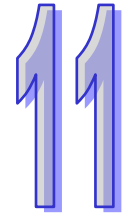

Chapter 11 Convenient Functions

Table of Contents

11.1	PLC Link (for AHCPU5X0 models).....	11-2
11.1.1	Introduction of a PLC Link.....	11-2
11.1.2	Constructing a PLC Link in NWCONFIG in ISPSOft.....	11-2
11.1.2.1	Opening the PLC Link Table Editor Window.....	11-3
11.1.2.2	Designating a Port as a Master Station (Step 1).....	11-4
11.1.2.3	Setting Communication Parameters (Step 2).....	11-6
11.1.2.4	Creating a Data Exchange Table (Step 3).....	11-7
11.1.2.5	Monitoring a PLC Link.....	11-14
11.1.2.6	Important Points About Constructing a PLC Link.....	11-18
11.1.3	Executing a PLC Link through the Program in ISPSOft.....	11-20
11.1.3.1	Parameters Related to a PLC Link.....	11-20
11.1.3.2	Setting a PLC Link.....	11-25
11.1.4	Related Special Auxiliary Relays and Special Data Registers.....	11-31
11.2	Ether Link (for AHCPU5X0 models).....	11-33
11.2.1	Introduction of an Ether Link.....	11-33
11.2.1.1	General Specifications and Functions.....	11-34
11.2.1.2	Steps of Constructing an Ether Link.....	11-35
11.2.2	Constructing an Ether Link in NWCONFIG in ISPSOft.....	11-36
11.2.2.1	Constructing an Ether Link.....	11-36
11.2.2.2	Opening the Ether Link Configuration Window.....	11-36
11.2.2.3	Creating and Managing a Data Exchange Table.....	11-38
11.2.2.4	Node List and Display Area.....	11-41
11.2.2.5	Start Mode of an Ether Link.....	11-43
11.2.2.6	Downloading the Parameters Related to an Ether Link.....	11-45
11.2.2.7	Uploading the Parameters Related to an Ether Link.....	11-47
11.2.2.8	Deleting Asynchronous Device.....	11-48
11.2.2.9	Enabling/Disabling the Online Monitoring Function.....	11-49
11.2.2.10	Starting/Stopping the Execution of an Ether Link Online.....	11-53
11.2.2.11	Monitoring Table and Error Log.....	11-56
11.2.3	Related Special Auxiliary Relays and Special Data Registers.....	11-57
11.3	Data Exchange Function.....	11-60
11.3.1	MODBUS Data Exchange.....	11-60
11.3.1.1	MODBUS Data Exchange.....	11-60
11.3.1.2	MODBUS Data Exchange - PLC Parameter Setting.....	11-60
11.3.1.3	MODBUS Data Exchange - Downloading/Uploading Parameters.....	11-63
11.3.1.4	MODBUS Data Exchange – Special Auxiliary Relays.....	11-64
11.3.2	MODBUS TCP Data Exchange.....	11-87
11.3.2.1	MODBUS TCP Data Exchange.....	11-87
11.3.2.2	MODBUS TCP Data Exchange - PLC Parameter Setting.....	11-88
11.3.2.3	MODBUS TCP Data Exchange - Downloading/Uploading Parameters.....	11-93
11.3.2.4	MODBUS TCP Data Exchange – Special Auxiliary Relays.....	11-95
11.4	Web.....	11-128
11.4.1	Introduction.....	11-128
11.4.2	Usage.....	11-128
11.4.3	Troubleshooting.....	11-130
11.5	EtherNet/IP.....	11-133

11.1 PLC Link (for AHCPU5X0 models)

This function is applicable for AH500 basic CPU module series (AHCPU500/510/520/530).

11.1.1 Introduction of a PLC Link

A PLC Link is a network mechanism for data exchange performed through an RS-485 cable. If there are several nodes in an RS-485 network, users can create a mechanism for data exchange in the network. If the parameters which are set are downloaded to the PLC which functions as a master station, the system of the PLC will perform data exchange through special auxiliary relays and special data registers when the PLC runs.

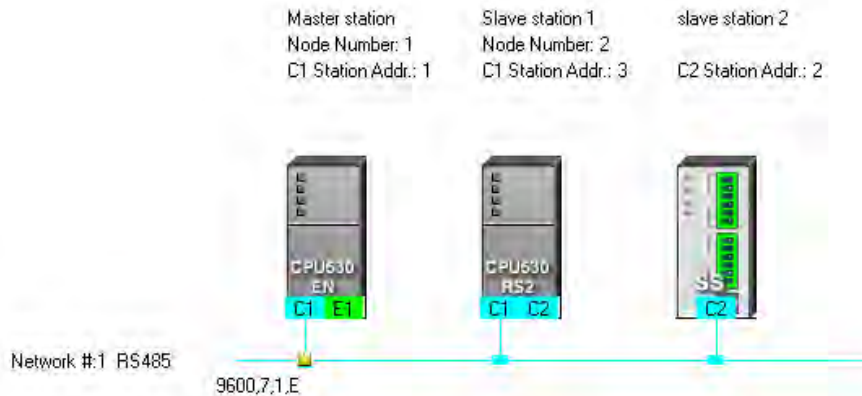

11.1.2 Constructing a PLC Link in NWCONFIG in ISPSoft

Constructing a PLC Link

A PLC Link is a network mechanism for data exchange performed through an RS-485 cable. If there are several nodes in an RS-485 network, users can create a mechanism for data exchange in the network. If the parameters which are set are downloaded to the PLC which functions as a master station, the system of the PLC will perform data exchange through special auxiliary relays and special data registers when the PLC runs. A PLC Link is a master/slave model. There is only one master station in an RS-485 network, and the other stations which are slave stations passively receive reading/writing commands from the master station. The slave stations can not exchange data. They have to exchange data through the master station.

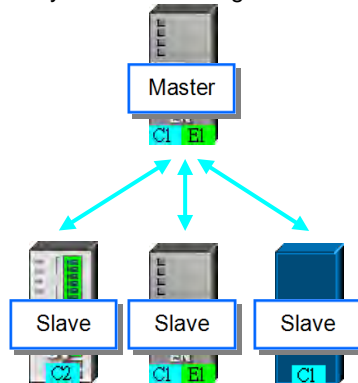

11.1.2.1 Opening the PLC Link Table Editor Window

Before creating a PLC Link, users have to make sure that all the network setting is correct. Please use one of the methods described below.

- **Method 1**

After the users select a network, they have to click **Construct PLC Link** on the **Tools** menu, or  on the toolbar.

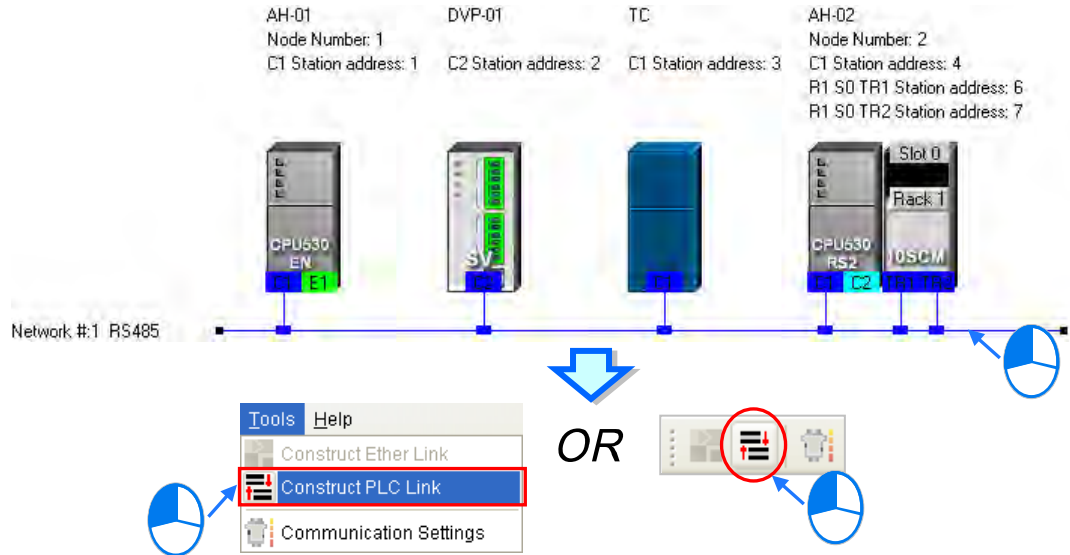

- **Method 2**

Double-click network.

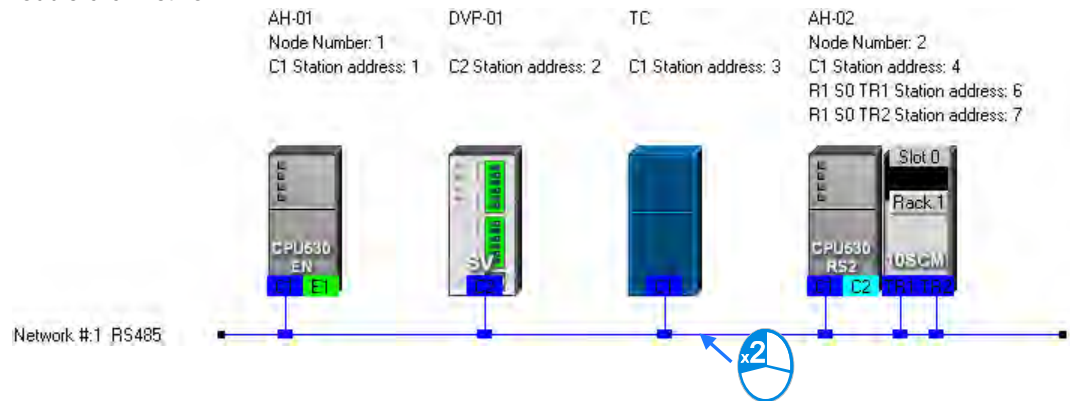

11

● **Method 3**

Right-click a network, and then click **Construct PLC Link** on the context menu.

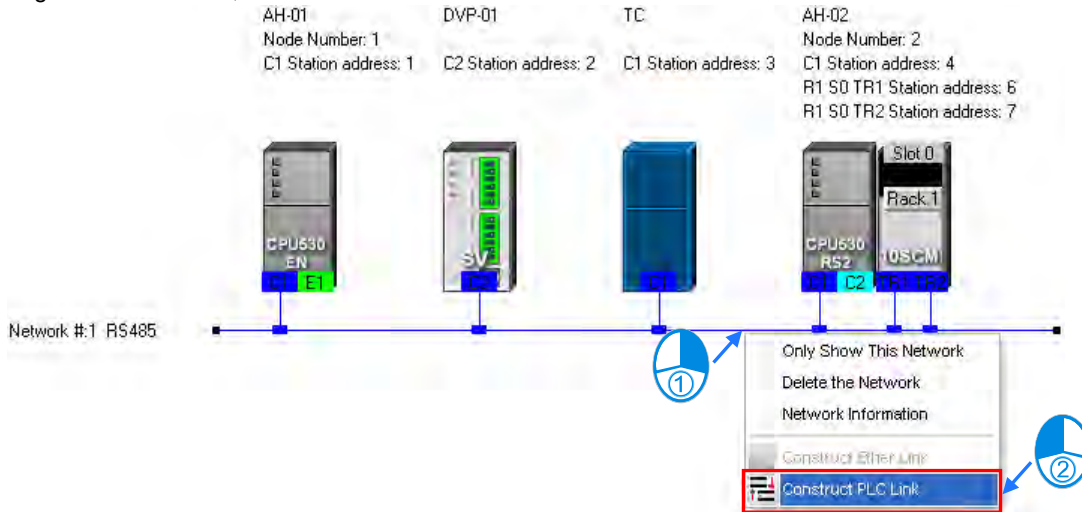

After the users use one of the methods described above, the **PLC Link Table Editor** window will be opened. The **PLC Link Table Editor** window leads the users to construct a PLC Link step by step. The steps of constructing a PLC Link are designating a port as a master station, setting communication parameters, and creating a data exchange table. The system leads the users to the operation screen displayed last time as soon as the **PLC Link Table Editor** window is opened. As a result, if the users construct a PLC Link for the first time, the screen displayed will lead the users to accomplish the first step.

Besides, a PLC Link is executed through special auxiliary relays and special data registers. The construction tool introduced here is just a friendly user interface which helps users download the parameters related to a PLC Link to the related special auxiliary relays and the related special data registers. The exact execution of a PLC Link depends on the special auxiliary relays and the special data registers in a PLC. To ensure that the PLC Link constructed can operate normally, users have to make sure of the functions of the PLCs and the limitations of the PLCs with regard to the PLC Link.

11.1.2.2 Designating a Port as a Master Station (Step 1)

Only an AH500 series CPU module, an AH500 series module, a DVP series PLC, or a DVP series module can be designated as the master station. Not all ports of a PLC or a module can be designated as the master station, and therefore users have to read the usage of the PLC or the module before they designate a port as the master station. Besides, if some of the ports of a node can be designated as masters, the PLC which is a part of the node will execute the PLC Link no matter what port is designated as a master station.

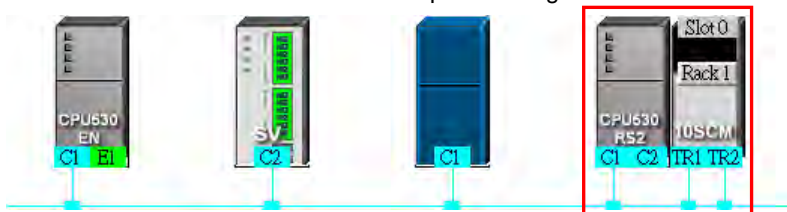

- (1) Select a port of a node in the **Master Device** drop-down list box. Only the ports which can be designated as master stations are listed.

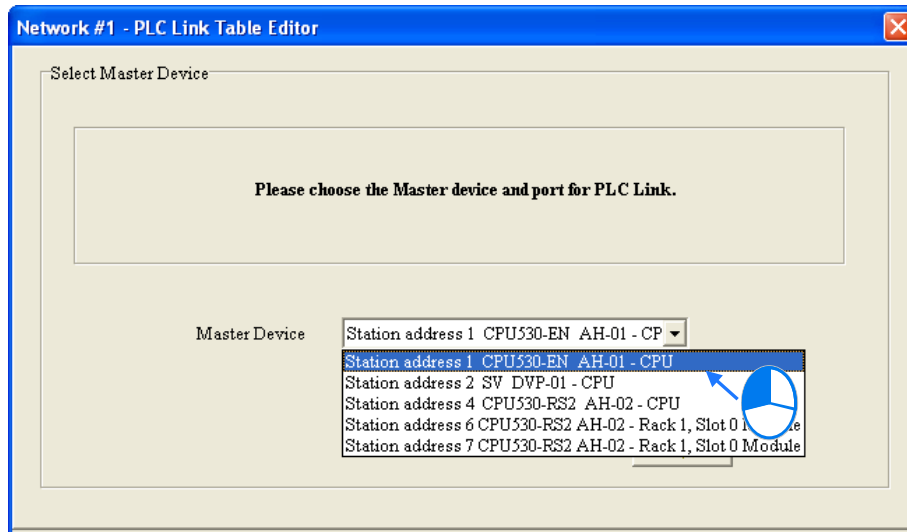

- (2) After users click , the system will ask the users whether they want to upload the setting related to a PLC Link through the master station. If the users click **No**, they will be led to the second step. If the users click **Yes**, the setting related to a PLC Link in the PLC which is a part of the node will be uploaded through the master station, and the data uploaded will be displayed on the screen after the users are led to the third step. Before the users upload the data, they have to make sure of the following points.
- The users have to make sure that the computer and the port designated as a master station are connected by means of a communication cable.
 - The users have to make sure that a driver has been created correctly, and the driver is started.
 - The users have to make sure that they have completed the communication setting in NWCONFIG.

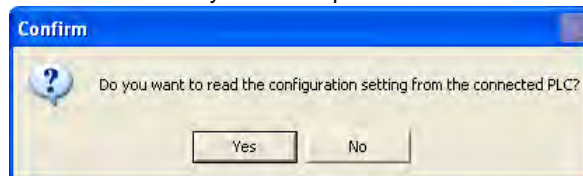

11.1.2.3 Setting Communication Parameters (Step 2)

After the system leads users to the second step, the users have to set the communication parameters in the **PLC Link Table Editor** window. The parameters uploaded through the master station are displayed at the left part of the window. The setting of the communication parameters of all the slave stations in the same network must be the same as the setting of the communication parameters of the master station. If no parameters are uploaded, "Unknown" will be shown in the boxes at the left part of the window. If the station address uploaded is different from the station address assigned to the master station, the **Station Address** box will become red.

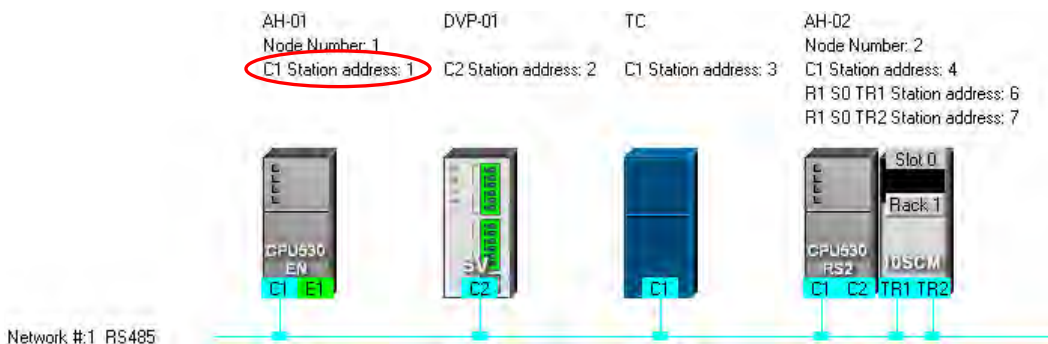
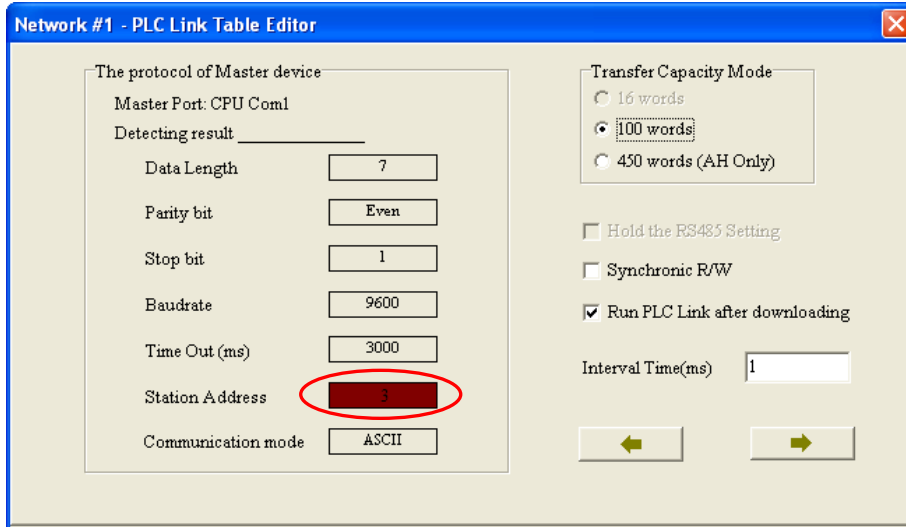

- **Transfer Capacity Mode**

The users can set 16 data exchange groups or 32 data exchange groups, depending on the model selected. The users can select a maximum data length in the **Transfer Capacity Mode** section. Besides, the maximum data length which can be set varies with the PLC which is designated as a master station. Please refer to manuals for more information.

If an AH500 series CPU module or an AH500 series module is designated as a master station, the **450 words (AH Only)** option button in the **Transfer Capacity Mode** section can be selected. Only AH500 series CPU modules allow 450-word data to be exchanged. As a result, if the **450 words (AH Only)** option button in the **Transfer Capacity Mode** section is selected, the DVP series PLCs and the other devices can not execute a PLC Link.

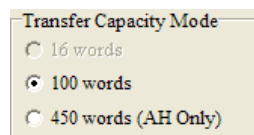



- **Hold the RS485 Setting**

Generally speaking, the communication parameters in a DVP series PLC will be restored to the default values if the DVP series PLC is turned on after a power failure. However, if the **Hold the RS485 Setting** checkbox is selected, the communication parameters stored will be loaded again if a DVP series PLC runs after it is stopped. Please refer to manuals for more information about the communication parameters in

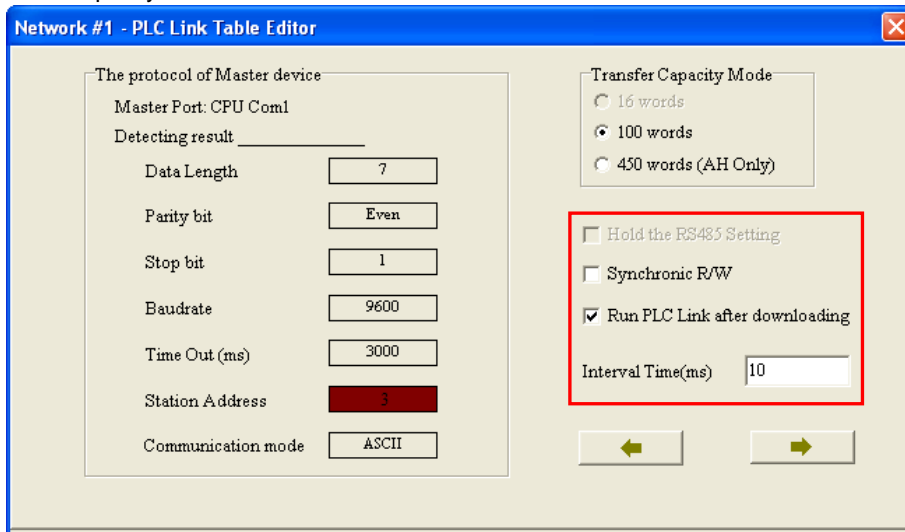
- DVP series PLCs.
- Synchronic R/W**
 Generally speaking, a master station sends a writing command and a reading command to a slave station separately. If the **Synchronic R/W** checkbox is selected, the master station can complete reading and writing simultaneously by means of a specific Modbus function code (the hexadecimal code 17), and the efficiency of data exchange is increased. However, the users have to make sure that the devices involved in data exchange support the Modbus function code before they select the **Synchronic R/W** checkbox. If the devices do not support the Modbus function code, the Modbus code can not be identified, and the reading/writing of data will fail after they receive the commands from the master station.
- Run PLC Link after downloading**
 If the **Run PLC Link after downloading** checkbox is selected, the PLC Link constructed will be enabled after the PLC Link constructed is downloaded to the PLC connected to the computer.
- Interval Time (ms)**
 The users can specify how often the master station sends a command.



After the users click , the system will lead the users to the next step. If the users click , the system will lead the users to the previous step.

11.1.2.4 Creating a Data Exchange Table (Step 3)

A. Introduction of a Data Exchange Table

The table below is a data exchange table. When a PLC Link is executed, the master station sends reading/writing commands to the slave stations according to the data exchange table created.

#	Station Addr.	R/W	Master Device Data	<=>	Slave Device Data	Length	Status	Device Type
4	3	R	D3400~D3424	<=	16#1000~16#1018	25	Enabled	MODBUS Device
		W	D3500~D3524	=>	16#1025~16#103D	25		
5	6	R	D3600~D3699	<=	D3000~D3099	100	Enabled	CPU530-RS2
		W	D3700~D3799	=>	D3100~D3199	100		
6	0	R	D500	<=	16#1000	0	Disabled	Unknown
		W	D500	=>	16#1000	0		
7	0	R	D600	<=	16#1000	0	Disabled	Unknown
		W	D600	=>	16#1000	0		
8	0	R	D700	<=	16#1000	0	Disabled	Unknown
		W	D700	=>	16#1000	0		

11

Column	Description
Serial Number (#)	The data exchange groups in the data exchange table in the PLC Link Table Editor window are numbered. Users can set 16 data exchange groups or 32 data exchange groups, depending on the model selected.
Station Addr.	The slave station address which belongs to a data exchange group is indicated. A station address can belong to several data exchange group. Besides, the station address 0 represents an undefined slave station, and is not a broadcast station address.
R/W	R: The master station reads the data in devices in a slave station. W: The master station writes data into devices in a slave station.
Master Device Data	The range of devices which are used in the master station is indicated.
<=>	<=: The master station reads the data in devices in a slave station. =>: The master station writes data into devices in a slave station.
Slave Device Data	The devices which are used in a slave station are indicated. If a slave station is a user-defined Modbus device, the devices used will be represented by hexadecimal addresses.
Length	A data length is indicated. A length indicates the number of devices used.
Status	Users can decide whether to involve a data exchange group in data exchange. If a data exchange group is set incorrectly, the data exchange group will not be involved in data exchange. If a data exchange group is not involved in data exchange, the related data will be on a gray ground.
Device Type	The device types shown are consistent with the device names shown in the working area in NWCONFIG. If a slave station address is assigned to a network module, the name of the PLC to which the network module is connected will be shown. Besides, if a slave station is undefined, it is unknown.

The figure below is an example of a data exchange table. Group #1, group #2, group #4, and group #5 are involved in data exchange. Please refer to the table below for more information.

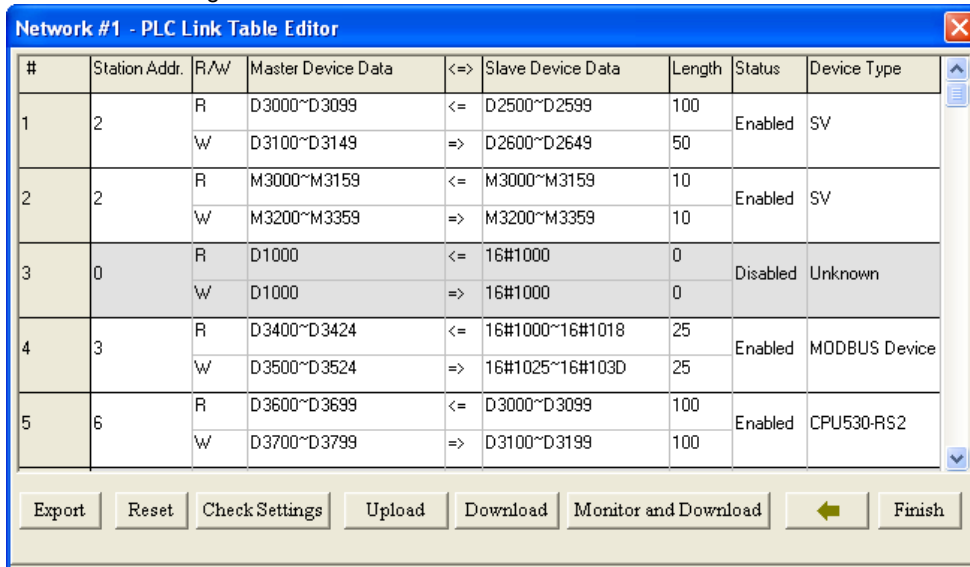

Serial number	Description
#1	The master station reads the data in D2500~D2599 in the slave station whose station number is 2, and stores the data in D3000~D3099 in itself. Meanwhile, the data in D3100~D3149 in the master station is written into D2600~D2649 in the slave station.
#2	The master station reads the data in M3000~M3159 in the slave station whose station number is 2, and stores the data in M3000~M3159 in itself. Meanwhile, the data in M3200~M3359 in the master station is written into M3200~M3359 in the slave station.

Serial number	Description
#4	The master station reads the data in 16#1000~16#1018 in the slave station whose station number is 3, and stores the data in D3400~D3424 in itself. Meanwhile, the data in D3500~D3524 in the master station is written into 16#1025~16#103D in the slave station.
#5	The master station reads the data in D3000~D3099 in the slave station whose station number is 6, and stores the data in D3600~D3699 in itself. Meanwhile, the data in D3700~D37999 in the master station is written into D3100~D3199 in the slave station.

11

Additional remark

If “Disabled” appears in the **Status** cell for a data exchange group, the data exchange group will not be involved in data exchange, and the system will ignore the setting in other cells for the data exchange group. Besides, if the setting of a data exchange group becomes incorrect after a modification, “Disabled” will appear in the **Status** cell for the data exchange group.

B. Setting a Data Exchange Group

If users want to set the parameters for a data exchange group, they can double-click the data exchange group in the data exchange table in the **PLC Link Table Editor** window.

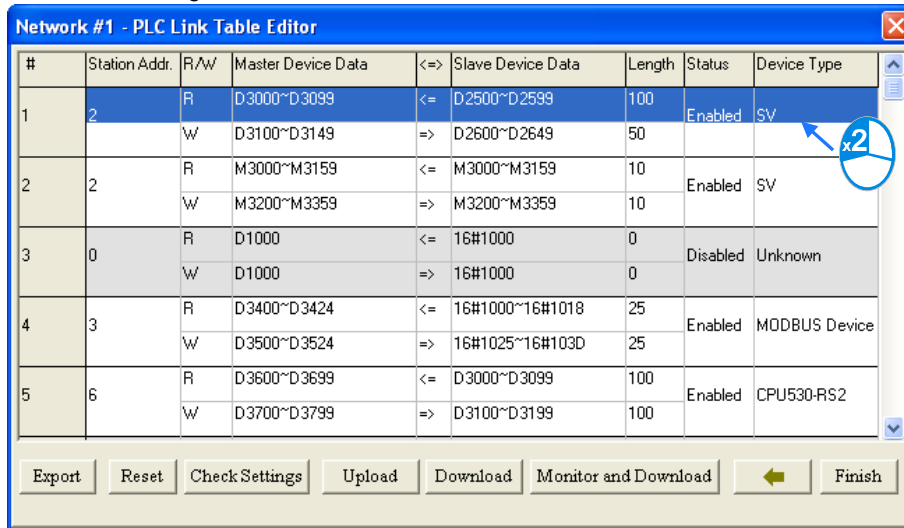

#	Station Addr.	R/W	Master Device Data	<=>	Slave Device Data	Length	Status	Device Type
1	2	R	D3000~D3099	<=>	D2500~D2599	100	Enabled	SV
		W	D3100~D3149	=>	D2600~D2649	50	Enabled	SV
2	2	R	M3000~M3159	<=>	M3000~M3159	10	Enabled	SV
		W	M3200~M3359	=>	M3200~M3359	10	Enabled	SV
3	0	R	D1000	<=>	16#1000	0	Disabled	Unknown
		W	D1000	=>	16#1000	0	Disabled	Unknown
4	3	R	D3400~D3424	<=>	16#1000~16#1018	25	Enabled	MODBUS Device
		W	D3500~D3524	=>	16#1025~16#103D	25	Enabled	MODBUS Device
5	6	R	D3600~D3699	<=>	D3000~D3099	100	Enabled	CPU530-RS2
		W	D3700~D3799	=>	D3100~D3199	100	Enabled	CPU530-RS2

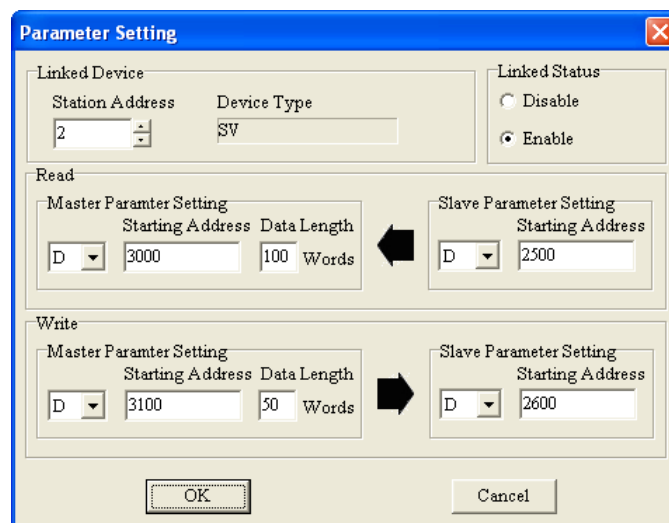
Parameter Setting

Linked Device
 Station Address: 2 Device Type: SV
 Linked Status
 Disable
 Enable

Read
 Master Parameter Setting: Starting Address: 3000, Data Length: 100 Words
 Slave Parameter Setting: Starting Address: 2500

Write
 Master Parameter Setting: Starting Address: 3100, Data Length: 50 Words
 Slave Parameter Setting: Starting Address: 2600

OK Cancel



● **Linked Device**

The users can select a slave station address which belongs to this data exchange group. The device type displayed in the **Device Type** box is a model name displayed in the working area in NWCONFIG. If the slave station address selected is assigned to a port of a network module, the name of the PLC to which the network module is connected will be shown in the **Device Type** box. If the slave station address selected is undefined, or is not involved in the PLC Link constructed, “Unknown” will be displayed in the **Device Type** box. Besides, the station address assigned to the master station can not be selected, and a slave station address can belong to several data exchange groups.

● **Linked Status**

After the users select a slave station address which can be used, they can select the **Disable** option button, or the **Enable** option button in the **Linked Status** section.

● **Read**

The users can select a device type, type a starting address, and type a data length in the **Master Parameter Setting** section. They can select a device type, and type a starting address in the **Slave Parameter Setting** section. Generally speaking, the device types selected in the **Read** section must be the same, and do not have to be the same as the device types selected in the **Write** section.

● **Write**

The users can select a device type, type a starting address, and type a data length in the **Master Parameter Setting** section. They can select a device type, and type a starting address in the **Slave Parameter Setting** section. Generally speaking, the device types selected in the **Write** section must be the same, and do not have to be the same as the device types selected in the **Read** section.

The data in a group of devices can be written into several different groups of devices, but the data in different groups of devices are not allowed to be stored in the same group of device. Take the figure above for example. The data in D3100~D3149 in the master station can be written into different slave stations, but D3000~D3099 in the master station can not receive the data in devices other than D2500~D2599 in the slave station whose station address is 2. Besides, the device types selected in the **Read/Write** section must be the same. However, the limitation on the setting of a data exchange group varies with the master station/slave station selected or the communication parameters selected.

Related setting	Description
The 450 words (AH Only) option button in the Transfer Capacity Mode section is selected.	Only AH500 series CPU modules allow 450-word data to be exchanged. As a result, if the 450 words (AH Only) option button in the Transfer Capacity Mode section is selected, the DVP series PLCs and the other devices can not execute a PLC Link. The users can only select M devices, D devices, or L devices in the Read/Write section. The device types selected in the Read/Write section do not have to be the same.

Related setting	Description
The 16 words option button in the Transfer Capacity Mode section is selected.	If the master station selected is a DVP series PLC, the 16 words option button in the Transfer Capacity Mode section can be selected. If the 16 words option button in the Transfer Capacity Mode section is selected, the starting device address in the Read/Write section will be a certain special data register, and the users can only specify a data length.
The slave station selected is a user-define device.	If the slave station selected is a Modbus device, the devices used will be represented by hexadecimal addresses, and the users can select word devices or bit devices.
The Synchronic R/W checkbox is selected.	If the 450 words (AH Only) option button is not selected, the users can only select D devices in the Read/Write section after the Synchronic R/W checkbox is selected.

C. Consistency Between a Data Exchange Table and the Network Created in NWCONFIG

The device types shown in the data exchange table in the **PLC Link Table Editor** window are consistent with the device names shown in the working area in NWCONFIG. Besides, if a slave station address is assigned to a port of a network module, the name of the PLC to which the network module is connected will be shown.

#	Station Addr.	R/W	Master Device Data	<=>	Slave Device Data	Length	Status	Device Type
1	2	R W	D0~D99 D0~D99	<=>	D100~D199 D200~D299	100 100	Enabled	SV
2	3	R W	D100~D199 D100~D199	<=>	16#1000~16#1063 16#1000~16#1063	100 100	Enabled	MODBUS Device
3	4	R W	D200~D299 D200~D299	<=>	D100~D199 D200~D299	100 100	Enabled	CPU530-RS2
4	6	R W	D300~D399 D300~D399	<=>	D100~D199 D200~D299	100 100	Enabled	CPU530-RS2
5	7	R W	D400~D499 D400~D499	<=>	D100~D199 D200~D299	100 100	Enabled	CPU530-RS2

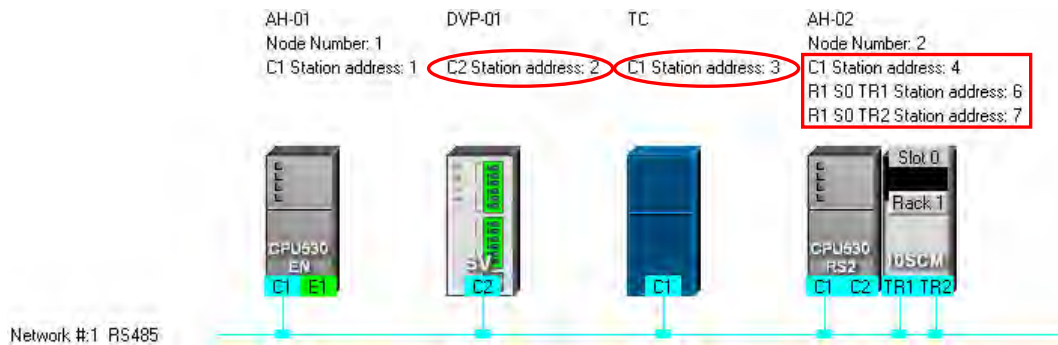

If users change the model to which a station address is assigned in NWCONFIG after a PLC Link is constructed, the new model name appearing in the **Device Type** cell for the station address will be in red, and “Disabled” will appear in the **Status** cell for the station address. The users have to check whether the setting is correct. If the setting is incorrect, the users have to modify the incorrect parts. After the users modify the incorrect parts, they can select the **Enable** option button in the **Linked Status** section.

11

#	Station Addr.	R/W	Master Device Data	<=>	Slave Device Data	Length	Status	Device Type
1	2	R	D3000~D3099	<=>	D2500~D2599	100	Disabled	DMV1000
		W	D3100~D3149	=>	D2600~D2649	50		

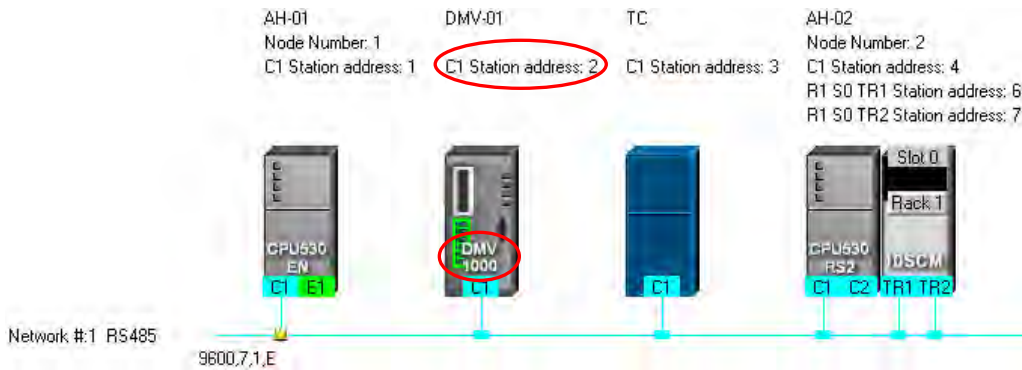

If the data uploaded from the master station which is an AH500 series CPU module is not consistent with the network created in NWCONFIG, the device types shown in the data exchange table in the **PLC Link Table Editor** window will still be consistent with the device names shown in the working area in NWCONFIG, the incorrect device types will be in red, and “Disabled” will appear in the **Status** cell for the incorrect device types. The users have to check whether the setting is correct. If the setting is incorrect, the users have to modify the incorrect parts. After the users modify the incorrect parts, they can select the **Enable** option button in the **Linked Status** section.

#	Station Addr.	R/W	Master Device Data	<=>	Slave Device Data	Length	Status	Device Type
2	3	R	D100~D115	<=>	D100~D115	16	Disabled	SX
		W	D100~D115	=>	D200~D215	16		

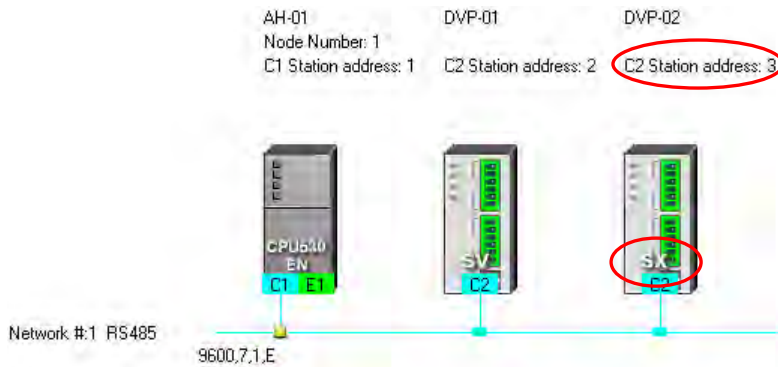

The device types in the data exchange table in the **PLC Link Table Editor** window can not be stored in a DVP series PLC, and therefore the users do not know whether the data uploaded from the DVP series PLC is consistent with the network created in NWCONFIG. The device types shown in the data exchange table in the **PLC Link Table Editor** window is consistent with the device names shown in the working area in NWCONFIG. If the device ranges set for a model is incorrect, “Disabled” will appear in the **Status** cell for the model. The users have to modify the incorrect parts. After the users modify the incorrect parts, they can select the **Enable** option button in the **Linked Status** section.

The figure below is a data exchange table which is downloaded to a DVP-SV series PLC. The slave station to which the station address 1 is assigned is AHCPU530-EN.

#	Station Addr.	R/W	Master Device Data	<=>	Slave Device Data	Length	Status	Device Type
1	1	R	D0~D99	<=>	D32000~D32099	100	Enabled	CPU530-EN
		W	D100~D199	=>	D200~D299	100		

The present network created in NWCONFIG is shown below. The slave station to which the station address 1 is assigned is a DVP-SV2 series PLC. After the data exchange table in the DVP-SV series PLC is uploaded, the device types shown in the data exchange table in the **PLC Link Table Editor** window will be consistent with the device names shown in the working area in NWCONFIG. The device ranges set for the DVP-SV2 series PLC is not within the device range for DVP-SV2 series PLC, and therefore “Disabled” appears in the **Status** cell for the DVP-SV2 series PLC.

#	Station Addr.	R/W	Master Device Data	<=>	Slave Device Data	Length	Status	Device Type
1	1	R	D0~D99	<=	Address error	100	Disabled	SV2
		W	D100~D199	=>	Address error	100		

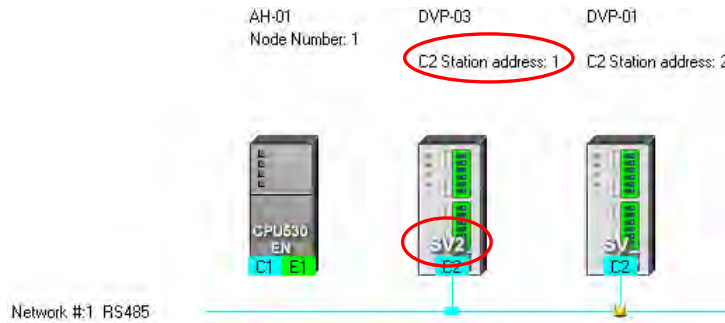

D. Managing a Data Exchange Table

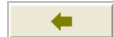
There are buttons under the data exchange table in the **PLC Link Table Editor** window. Please refer to the table below for more information about the buttons. If users click , the system will lead the users to the previous step.

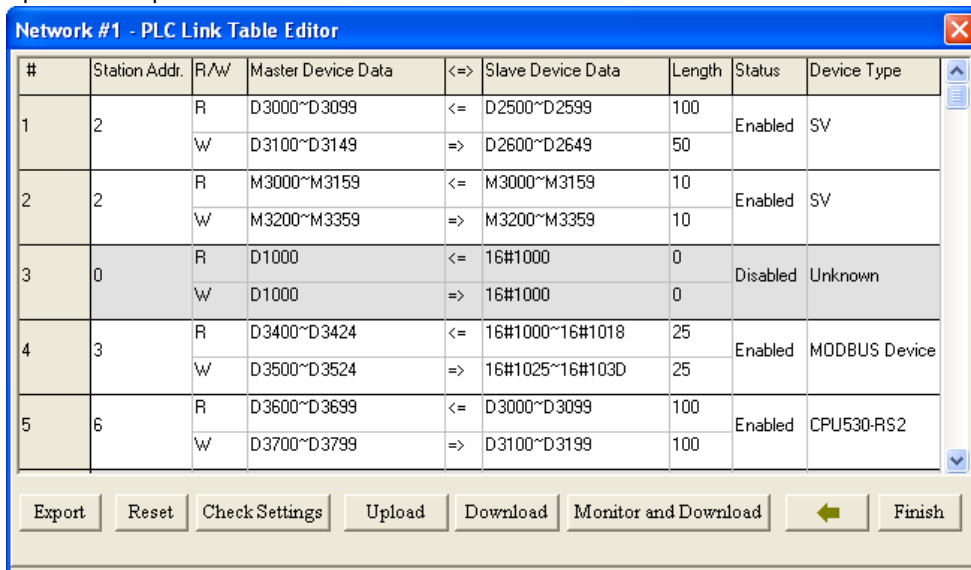

Item	Description
Export	The data in the data exchange table can be exported as a CSV file. The users can edit the CSV file through Microsoft Excel. The CSV file can also be used as reference material for another development work.
Reset	After the users click the button, the setting in the data exchange table will be restored to the initial setting.
Check Settings	After the users click the button, the data exchange table will be checked.
Upload	After the users click the button, the parameters related to a PLC Link in the master station will be uploaded.
Download	After the users make sure that the setting of a PLC Link is correct, they can download the setting to the master station by clicking the button.

11

Item	Description
Monitor and Download	After the users make sure that the setting of a PLC Link is correct, they can download the setting to the master station. After the setting is downloaded to the master station, the Linked Machines Status window will be opened automatically.
Finish	After the users click this button, the PLC Link Table Editor window will be closed. Before the PLC Link Table Editor window is closed, the system will ask the users whether they want to save the modifications they make.

During the execution of a PLC Link, the slave stations passively receive reading/writing commands from the master station. As a result, the parameters set in the data exchange table in the **PLC Link Table Editor** window are for the master station. If the users click **Upload**, the parameters related to a PLC Link in the master station will be uploaded. If the users click **Download**, the setting in the data exchange table in the **PLC Link Table Editor** window will be downloaded to the master station. Likewise, the master station will be monitored if the users click **Monitor and Download**. Before the users click **Upload**, **Download**, or **Monitor and Download**, they have to make sure that the device which is connected to the computer is the PLC which is designated as a master station, and the computer can communicate with the PLC normally. Please refer to section 16.1.3 for more information.

11.1.2.5 Monitoring a PLC Link

Before users monitor the PLC Link constructed, they have to make sure that the system is connect to the PLC which is designated as a master station normally. Please refer to section 16.1.3 for more information. After the users make sure that the PLC Link constructed is correct, they can click **Monitor and Download** under the data exchange table in the **PLC Link Table Editor** window to open the **Linked Machines Status** window. Besides, a PLC link can be executed normally only if the master station runs. As a result, the users have to make sure that the PLC which is designated as a master station runs before they monitor the PLC Link constructed.

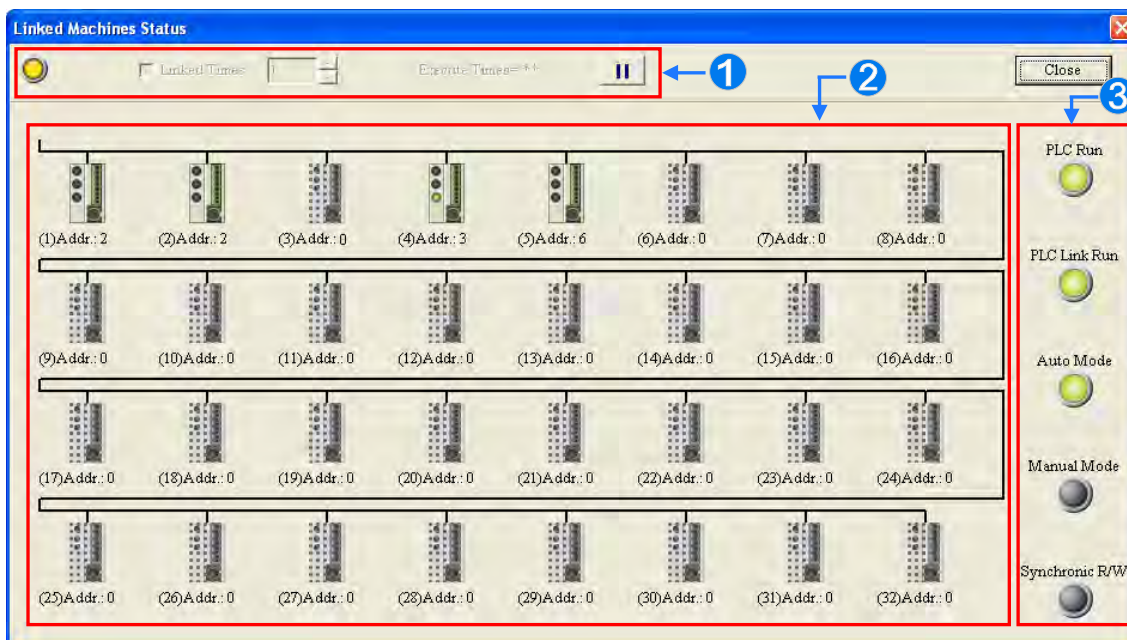
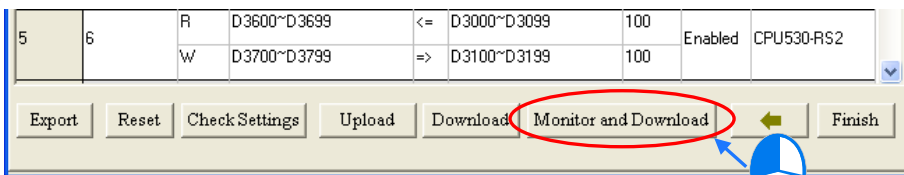

- ① **Setting area:** The users can set the PLC Link constructed.
- ② **Monitoring area:** The status of the data exchange between the master station and the slave stations is

displayed in this area. The users can also edit registers online in this area.

- ③ **Indicators:** The LED indicators indicate the status of the PLC Link constructed. Please refer to the table below for more information.

Indicator	Description
PLC Run	When the PLC which is designated as a master station runs, the indicator is ON.
PLC Link Run	When the master station executes the PLC Link constructed, the indicator is ON.
Auto Mode	When the PLC Link constructed is executed automatically, the indicator is ON.
Manual mode	When the PLC Link constructed is executed manually, the indicator is ON. After the master station polls the slave stations a certain number of times, the indicator will be OFF.
Synchronic R/W	When the synchronic reading/writing function is enabled, the indicator is ON.

11

● **Setting area**

The users can set the PLC Link constructed. If the users set the PLC Link constructed, the values in the related special data registers in the master station and the states of the related special auxiliary relays in the master station will be changed. After the users click **Close**, the status of the PLC Link will remain unchanged. As a result, the users have to make sure that the status of the PLC Link constructed is correct before they click **Close**.



- ① When the computer is connected to the PLC which is designated as a master station, the indicator blinks.
- ② If the **Linked Times** checkbox is selected, the PLC Link constructed will be executed manually. If the **Linked Times** checkbox is unselected, the PLC Link constructed will be executed automatically.
- ③ If the PLC Link constructed is executed manually, the users can set the number of times the master station polls the slave stations. The master station can poll the slave stations 65535 times at most. After the master station polls the slave stations a certain number of times, the PLC Link constructed will not be executed.
- ④ If the PLC Link constructed is executed manually, the number of times the PLC Link is executed will be displayed. If the master station exchanges data with all the slave stations once, the number of times the PLC Links constructed is executed will be one.
- ⑤ The users can start or stop the execution of the PLC Link constructed by clicking the button. If the system is disconnect from the PLC which is designated as a master station while the PLC Link constructed is monitored, the **Continue to Monitor** button will appear in the upper right corner of the **Linked Machines Status** window. After the users eliminate the problem which results in the disconnection, they can click the **Continue to Monitor** button.



● **Monitoring area**

When the PLC Link constructed is executed, the master station exchanges data with the slave stations. The status of the data exchange between the master station and the slave stations are displayed in this area.

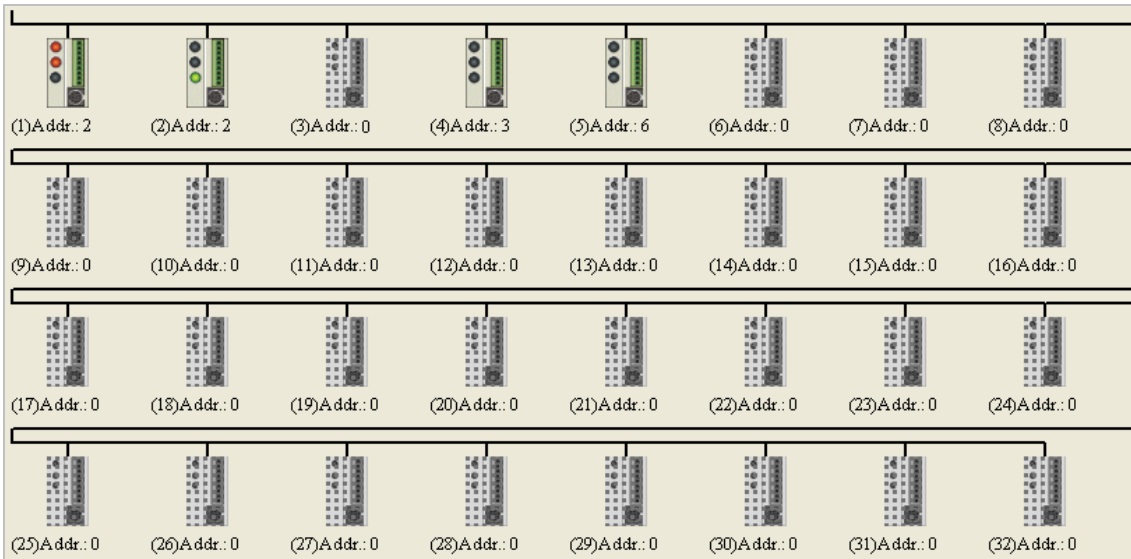

The small pictures in the monitoring area indicate the status of the main station rather than the statuses of the slave stations. The small pictures in the monitoring area are described below.

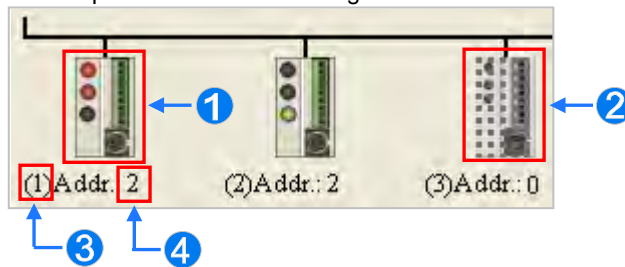

- ❶ The indicators on the small picture indicate the status of the data exchange group represented by the small picture.
- ❷ The data exchange group represented by the small picture is not involved in data exchange.
- ❸ The number corresponds to a serial number in the data exchange table. It represents the serial number of the data exchange group represented by the small picture.
- ❹ The number corresponds to a slave station address in the data exchange table. It represents the slave station address which belongs to the data exchange group represented by the small picture.

Besides, the PLC Link error flags in an AH500 series CPU module are slightly different from the PLC Link error flags in a DVP series PLC, and therefore the small picture representing an AH500 series CPU module is different from the small picture representing a DVP series PLC. Please refer to the following table for more information.

Master station	Small picture	Description
AH500 series CPU module		<ul style="list-style-type: none"> ❶ If an error occurs when data in a slave station is read, the indicator will be ON. ❷ If an error occurs when data is written into a slave station, the indicator will be ON. ❸ When data exchange is performed, the indicator will be ON.
DVP series PLC		<ul style="list-style-type: none"> ❶ If an error occurs when data in a slave station is read, or an error occurs when data is written into a slave station, the indicator will be ON. ❷ When data exchange is performed, the indicator will be ON.

After the users select a small picture, and right-click the small picture, they can click **Write Register** or

Read Register on the context menu.

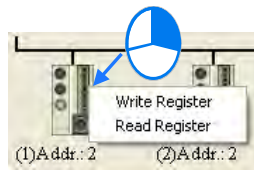

11

- **Write Register:** The data written into the slave station specified is stored in registers in the master station. For example, D3100~D3149 in the figure below are write registers.
- **Read Register:** The data **read** from the slave station specified is stored in registers in the master station. For example, D3000~D3099 in the figure below are read registers.

#	Station Addr.	R/W	Master Device Data	<=>	Slave Device Data	Length	Status	Device Type
1	2	R	D3000~D3099	<=	D2500~D2599	100	Enabled	SV
		W	D3100~D3149	=>	D2600~D2649	50		

After the users click **Write Register** or **Read Register** on the context menu, a corresponding register monitoring table will appear.

Input Value

Device Name	Value	Device Comment
D3100	0	
D3101	0	
D3102	0	
D3103	0	
D3104	0	
D3105	0	
D3106	0	
D3107	0	
D3108	0	
D3109	0	
D3110	0	
D3111	0	
D3112	0	
D3113	0	
D3114	0	

Value Type

Decimal

Hexdecima

A data format can be selected.

Close

If the users double-click the **Value** cell for a device, or click **Edit Value** on the context menu after they right-click the **Value** cell, they can type a value in the **Enter Value** window. If the users double-click the **Device Comment** cell for a device, or click **Edit Comment** on the context menu after they right-click the **Device Comment** cell, they can make a comment on the device. The comments made are for the PLC Link constructed. They are not related to the comments on the devices in the program created in ISPSOft.

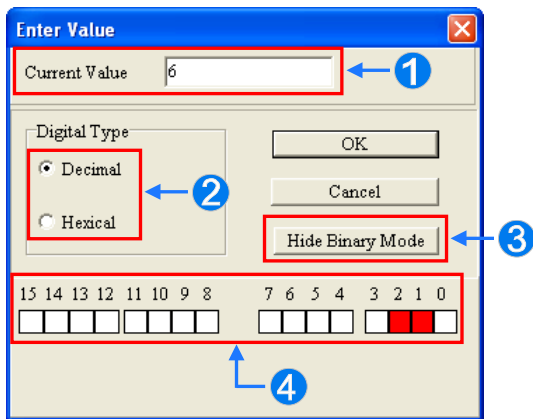
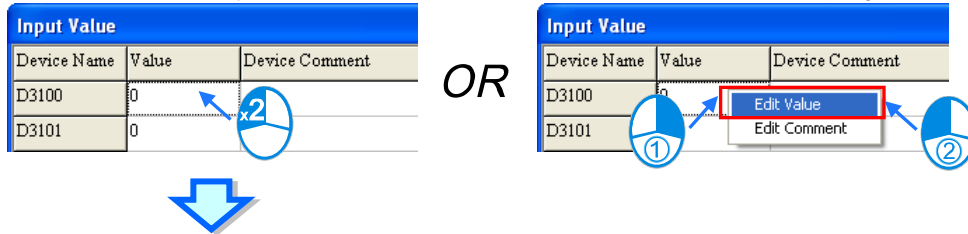

- 1 Users can type a value in the box.
- 2 Users can select a data format.
- 3 Users can display or hide the binary mode.
- 4 In the binary mode, users can set the states of the bits through the mouse.

11.1.2.6 Important Points About Constructing a PLC Link

There is only one master station in an RS-485 network. If the node designated as a master station has several serial ports, the node can not be designated as a master station in another RS-485 network, but can be designated as a slave station in another RS-485 network. In the figure below, C1 on the node AH-01 is designated as a master station in network #1, and TR1 on the node AH-01 is designated as a slave station in network #2. Besides, C1 on AH-01 and TR2 on AH-01 are connected to network #1. The station addresses assigned to these two ports are different. As a result, TR2 is allowed to be designated as a slaved station in network #1.

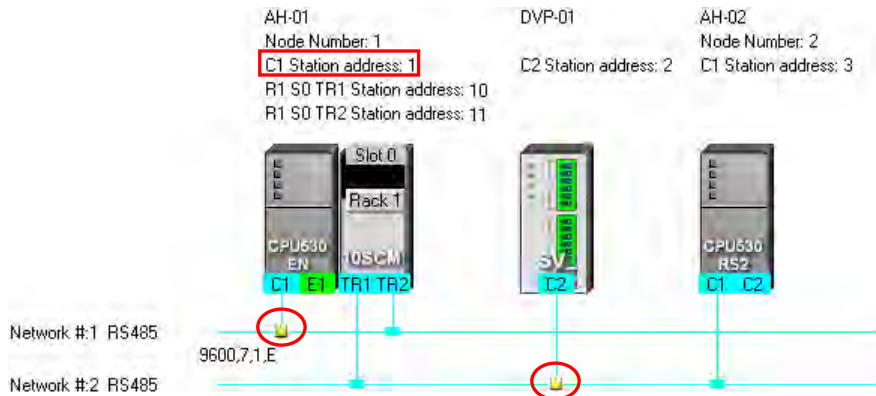

When a PLC Link is executed, the master station sends reading/writing commands to the slave stations according to the data exchange table created. Another master station which can send commands is not allowed to exist. If there is an unknown device which does not appear in NWCONFIG and which can send commands in an RS-485 network, or there is a device which is designated as a slave station and which can send reading/writing commands in an RS-485 network, an error occurs when more than one device sends commands. As a result, after users create a network in NWCONIFG, they have to make sure that the actual connection is consistent with the network created in NWCONFIG.

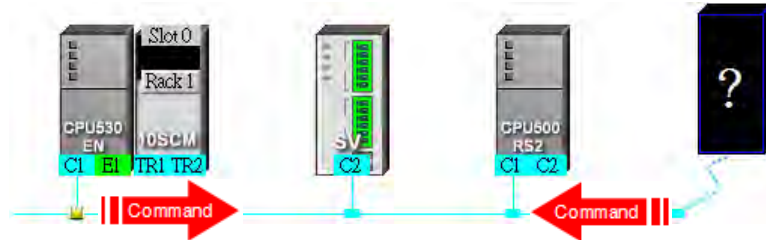

Besides, if the users do not set the parameters related to a PLC Link in the original master station again before they designate another device as a master station, an error occurs when more than one device sends reading/writing commands. As a result, if the users want to designate another device as a master station, they have to make sure that the original master station does not execute the original PLC Link.

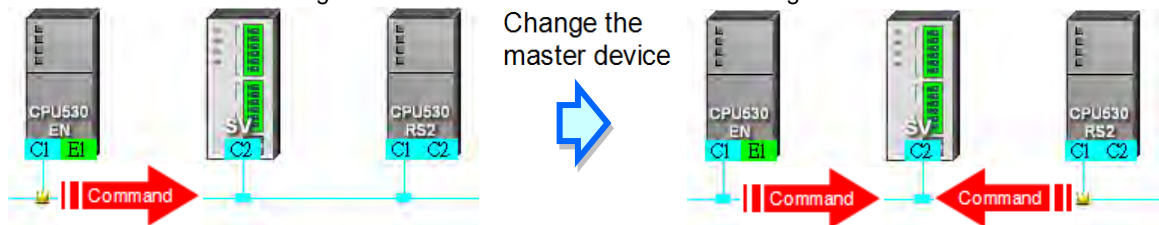

* In addition to the conditions mentioned above, users have to prevent two devices or more than two devices from sending reading/writing commands simultaneously in any conditions.

11.1.3 Executing a PLC Link through the Program in ISPSoft

Users can execute a PLC Link through the program in ISPSoft. The setting of the parameters related to a PLC Links is described in this section. Users can execute a PLC Link efficiently.

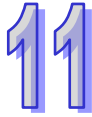

11.1.3.1 Parameters Related to a PLC Link

1. The special data registers and the special auxiliary relays for slave 1~slave 32 are described below.

		Master station						
		Slave station 1		Slave station 2		...	Slave station 32	
		Read	Write	Read	Write	...	Read	Write
Latched area	Address in the master: The device address into which the data is read (SR1404 and SR1405)	Address in the master: The device address from which the data is written (SR1468 and SR1469)	Address in the master: The device address into which the data is read (SR1406 and SR1407)	Address in the master: The device address from which the data is written (SR1470 and SR1471)	...	Address in the master: The device address into which the data is read (SR1466 and SR1467)	Address in the master: The device address from which the data is written (SR1530 and SR1531)	
	Address in the slave: The device address from which the data is read (SR1532 and SR1533)	Address in the slave: The device address into which the data is written (SR1596 and SR1597)	Address in the slave: The device address from which the data is read (SR1534 and SR1535)	Address in the slave: The device address into which the data is written (SR1598 and SR1599)	...	Address in the slave: The device address from which the data is read (SR1594 and SR1595)	Address in the slave: The device address into which the data is written (SR1658 and SR1659)	
	Number of data which is read from the slave (SR1660)	Number of data which is written into the slave (SR1692)	Number of data which is read from the slave (SR1661)	Number of data which is written into the slave (SR1693)	...	Number of data which is read from the slave (SR1691)	Number of data which is written into the slave (SR1723)	
	Device type (SR1340)	Device type (SR1372)	Device type (SR1341)	Device type (SR1373)	...	Device type (SR1371)	Device type (SR1403)	
	Type of slave 1 (SR1724)		Type of slave 2 (SR1725)		...	Type of slave 32 (SR1755)		
	Address of slave 1 (SR1756)		Address of slave 2 (SR1757)		...	Address of slave 32 (SR1787)		
	PLC Link flag (SM1392)		PLC Link flag (SM1393)		...	PLC Link flag (SM1423)		
	Data exchange flag (SM1424)		Data exchange flag (SM1425)		...	Data exchange flag (SM1455)		
Non-latched area	Read error flag (SM1456)	Write error flag (SM1488)	Read error flag (SM1457)	Write error flag (SM1489)	...	Read error flag (SM1487)	Write error flag (SM1519)	
	The data reading is complete. (ON->OFF) (SM1520)		The data reading is complete. (ON->OFF) (SM1521)		...	The data reading is complete. (ON->OFF) (SM1551)		
	The data writing in the PLC Link is complete. (ON->OFF) (SM1552)		The data writing in the PLC Link is complete. (ON->OFF) (SM1553)		...	The data writing in the PLC Link is complete. (ON->OFF) (SM1583)		

*. SM1424~SM1583 are read-only devices.

- Start address in the master station: The start address in the master station is a device address. The default start address in the master station is D0. If the AH500 Modbus communication protocol is used, the start address in the master station is an AH500 Modbus device address. If the standard Modbus communication protocol is used, the start address in the master station is a Modbus device address. The data in the device addresses in the master station starting from the start address in the master station is sent to a slave, and the data sent by a slave station is stored in the devices in the master station starting from the start address in the master station. If the communication protocol used is the standard Modbus communication protocol, only M0~M8191 and D0~D32767 can be used. If the communication protocol used is the AH500 Modbus communication protocol, only M0~M8191,

D0~D65535, and L0~L65535 can be used.

- Start address in a slave station: The start address in a slave station is a device address. The default start address in a slave station is 0. The data in the device addresses in a slave station starting from the start address in the slave station is read, and the data sent by the master station is stored in the device addresses in a slave station starting from the start address in the slave station. If the communication protocol used is the standard Modbus communication protocol, only M0~M8191 and D0~D32767 can be used. If the communication protocol used is the AH500 communication protocol, only M0~M8191, D0~D65535, and L0~L65535 can be used. If a slave station is not an AH500 CPU module, the start address in the slave station must be an absolute address, e.g. 16#1000.
- Number of data read from a slave station: The default value is 0. If the devices used are registers, the unit of data length is a word. If the devices used are contacts, the unit of data length is a bit.
- Number of data written into a slave station: The default value is 0. If the devices used are registers, the unit of data length is a word. If the devices used are contacts, the unit of data length is a bit.
- An AH500 series CPU module can modify the data length automatically. If data length is larger than 450/100 (the AH500 communication protocol/the standard Modbus protocol) words, it will be modified automatically and become 450/100 words. If data length is larger than 7200/1600 (the AH500 communication protocol/the standard Modbus protocol) bits, it will be modified automatically and become 7200/1600 bits.
- A DVP series PLC can modify the data length automatically. If data length is larger than 100 words, it will be modified automatically and become 100 words. If data length is larger than 1600 bits, it will be modified automatically and become 1600 bits.
- Slave station type: The models which can be connected to the master station can be AH500 series CPU modules, DVP series PLCs, and other models. (The default value is 0.)
- After a CPU module is restored to the factory setting, the slave station address will become the default value. (The address of the 1st slave station will be 1, the address of the 2nd slave station will be 2, and the address of the 32th slave station will be 32.) If a PLC Link is executed, and SM1595 is ON, the slave station addresses in SR1756~SR1787 will be read. If a PLC Link is executed, and SM1595 is OFF, the slave station address in SR1756 will be read. A slave station address must be in the range of 1 to 216. If a slave station address is not in the range, it will become 1.
- Device type: The device type used by a slave station must be the same as the device type used by the master station. For example, if a slave station uses contact devices, the master station must use contact devices. The legal setting values are 0 (registers) and 1 (contacts). Other values are illegal values. If the value set is illegal, the slave station will not be involved in a data exchanged. The device type used for reading in a slave station can be set by means of SR1340, and the device type used for writing in a slave station can be set by by means of SR1372. (The default values in SR1340 and SR1372 are 0. (If the reading of data and the writing of data are synchronous, the device type used for reading must be the same as the device type used for writing.))

Additional remark:

A PLC Link can be executed only if the AH500 series CPU modules runs. If the number of data read from a slave station and the number of data written into a slave station are 0, no data exchange is performed. If a PLC Link is executed, the parameters related to the PLC link can not be modified. That is, a slave station can not be deleted or added if a PLC Link is executed. Only serial ports can be used as communication interfaces for data exchange performed by means of a PLC Link. (If an AH500 series CPU module used is AHCPU530-RS2, COM1 must be used for data exchange.)

2. Descriptions of flags:

- PLC Link flag: The state of a PLC Link flag indicates whether the corresponding slave station is connected to the master station. If SM1585 is ON, users can decide whether to connect a slave station to the master station.
- Data exchange flag: The state of a data exchange flag indicates whether the corresponding slave station and the master station exchange data with each other.
- Read error flag: If an error occurs when the master station reads data from a slave station, the corresponding read error flag will be ON. For example, if the command sent form a slave station is incorrect, or the checksum in the command sent form a slave station is incorrect, the corresponding read error flag will be ON.
- Write error flag: If an error occurs when the master station writes data into a slave station, the corresponding write error flag will be ON. For example, if the number of data written into a slave station is incorrect (is not in a device range), the write error flag will be ON.

- Completion of reading: The master station finishes reading data from a slave station
- Completion of writing: The master station finishes writing data into a slave station.

Additional remark:

If the reading of data and the writing of data are synchronous, the related flags will be controlled in the ways described below.

	Read error	Write error	Completion of reading	Completion of writing
The master station stops reading data and writing data simultaneously, or the master station is reading data and writing data simultaneously.	OFF	OFF	OFF	OFF
The master station finishes reading data and writing data simultaneously.	OFF	OFF	ON	ON
Timeout	ON	ON	OFF	OFF
The master station can not produce a packet which will be sent.	ON	ON	OFF	OFF
The data sent by a slave station can not be stored in the master station.	ON	OFF	OFF	ON

3. Description of the setting of the parameters related to a PLC Link:

The setting of the parameters related to a PLC Link is described below. (Suppose the master station and slave station 1 are AHCPU530-EN.) The data in the device addresses starting from D100 in slave station 1 is read into the device address starting from D9 in the master station. The number of data read from slave station 1 is 10. The data in the device addresses starting from Y0.0 in the master station is written into the device addresses starting from Y2.0 in slave station 1. The number of written into slave station 1 is 5. The slave station type is AHCPU530-EN (16#E001). The slave station address is 16#0001.

Item	Reading/Writing	Device code	Value
Start address in the master station	Reading	SR1404	16#0000
		SR1405	16#0009
	Writing	SR1468	16#0000
		SR1469	16#A000
Start address in slave station 1	Reading	SR1532	16#0000
		SR1533	16#0064
	Writing	SR1596	16#0000
		SR1597	16#A020
Number of data read from slave station 1	Reading	SR1660	16#000A
Number of data written into slave station 1	Writing	SR1692	16#0005
Slave station type	Reading	SR1724	16#E001
	Writing		
Slave station address	Reading	SR1756	16#0001
	Writing		
Device type	Reading	SR1340	16#0000
	Writing	SR1372	16#0001

Additional remark:

There are a variety of Delta PLCs. Users can construct a PLC Link by connecting AH500 series CPU modules to DVP series PLCs, and other models. Consequently, there are limitations on the devices which can be used, the data exchange which can be performed, and the number of data which can be exchanged.

- The limitation on data exchange performed by an AH500 series CPU module is described below.

Device	Device range	Maximum length of data which can be read/written
Relays	M0~M8191	450 registers/100 registers* 7200 contacts/1600 contacts*
Data register	D0~D65535	
Link register	L0~L65535	

*. Maximum length of data which can be read/written (Reading data and writing data synchronously)=Maximum length of data which can be read/written (Reading data and writing data asynchronously). A PLC which is not an AH500 series CPU module can read/write the data in 100 registers at most, and the data in 1600 contacts at most.

- If an AH500 series CPU module is a master station, DVP series PLCs can function as slave stations. DVP series PLCs can read data and write data simultaneously.

Model	Device code	Maximum data register address which can be used	Maximum relay address which can be used	Communication port which supports RS-485	Maximum length of data which can be read/written (word)*	
					Reading and writing data synchronously	Reading and writing data asynchronously
ES	0x0000	D599	M999	COM2	100	100
EX	0x0001	D599	M999	COM2	100	100
SS	0x0002	D599	M999	COM2	100	100
EC	0x0003	D599	M999	COM2	100	100
EH	0x0004	D9999	M4095	COM2	100	100
SA	0x0006	D4999	M4095	COM2	100	100
SC	0x0007	D4999	M4095	COM2	100	100
SX	0x0008	D4999	M4095	COM2	100	100
SV	0x0009	D9999	M4095	COM2	100	100
EH2-L	0x000A	D9999	M4095	COM2	100	100
EH2	0x000B	D9999	M4095	COM2	100	100
ES2	0x000C	D9999	M4095	COM2 and COM3	50	100
EX2	0x000D	D9999	M4095	COM2 and COM3	50	100
SS2	0x000E	D4999	M4095	COM2	50	100
SX2	0x000F	D9999	M4095	COM2	50	100
SV2	0x0010	D11999	M4095	COM2	100	100
EH3-L	0x0011	D11999	M4095	COM2 and COM3	100	100
EH3	0x0012	D11999	M4095	COM2 and COM3	100	100
SA2	0x0013	D9999	M4095	COM2 and COM3	50	100
MC	0x0014	D9999	M4095	COM2	50	100
SE	0x0015	D11999	M4095	COM2 and COM3	50	100

*. DVP series PLCs can modify the data length automatically.

➤ The rules of data exchange are described below.

Master station	Slave station	Communication	Data exchange	
			Master station <=> Slave station	
AH500 series CPU module	AH500 series CPU module	AH500 Modbus communication protocol	M, D, and L ^{*1}	M, D, and L ^{*1}
		Standard Modbus communication protocol	M ^{*2}	M ^{*2}
	DVP series PLC	Standard Modbus communication protocol	D	D
		Standard Modbus communication protocol	M ^{*2}	M ^{*2}
	Device which is neither an AH500 series CPU module nor a DVP series PLC	Standard Modbus communication protocol	D	D
		Standard Modbus communication protocol	M ^{*2}	H (contact) ^{*2}
DVP series PLC	AH500 series CPU module	Standard Modbus communication protocol	D	D
	DVP series PLC	Standard Modbus communication protocol	D	D
	Device which is neither an AH500 series CPU module nor a DVP series PLC	Standard Modbus communication protocol	D	H (register)

*1. If the AH500 Modbus communication protocol is used, users can use relays, data registers, and link registers.

*2. If the standard Modbus communication protocol is used, devices which are not data registers can not be involved in synchronous data exchange.



11.1.3.2 Setting a PLC Link

1. The process of setting a PLC Link is described below.

Step 1: Setting the parameters related to a PLC Link

Set the special data registers and the special auxiliary relays which are described in section 11.1.3.1.

Step 2: Assigning slave station addresses manually/automatically

If SM1595 is ON, users can assign station addresses to all the slave stations.

If SM1595 is OFF, users can assign a station address to slave station 1 (SR1756), and the system can assign the station addresses starting from the station address that users assign to slave station 1 to the other slave stations.

Step 3: Connecting to the slave stations manually/automatically

If SM1585 is ON, users can decide whether to connect a slave station to the master station by setting the PLC Link flag corresponding to the slave station. SM1392~SM1423 are PLC Link flags.

If SM1585 is OFF, the master station will connect to the slave stations to which station addresses are assigned.

Step 4: Reading data and writing data synchronously/Reading data and writing data asynchronously

Reading data and writing data synchronously: If SM1598 is ON, the master station will read data from a slave station, and write data into the slave station simultaneously.

Reading data and writing data asynchronously: If SM1598 is OFF, the master station will not read data from a slave station, and write data into the slave station simultaneously.

Step 5: PLC Link in the manual/automatic mode

PLC Link in the manual mode: Before users set SM1587 to ON, they have to set the number of times the master station exchanges data with all the slave stations (SR1338). The number of times the master station exchanges data with all the slave stations is displayed in SR1337. If the value in SR1338 is 0, SM1592 will be ON. The value in SR1338 can not be 0.

Users have to set SM1587 and SM1584 to ON first. If the value in SR1337 becomes the same as the value in SR1338, the execution of the PLC Link will stop, and SM1584 will become OFF. If the users want to execute the PLC Link in the manual mode again, they have to set SM1587 and SM1584 to ON again.

PLC Link in the automatic mode: After users set SM1586 and SM1584 to ON, the master station will exchange data with all the slave stations. The PLC Link will be executed until MS1584 or SM1586 becomes OFF.

Step 6: Enabling the function of executing a PLC Link

After the setting of all the parameters is complete, users can set SM1584 to ON.

Flowchart:

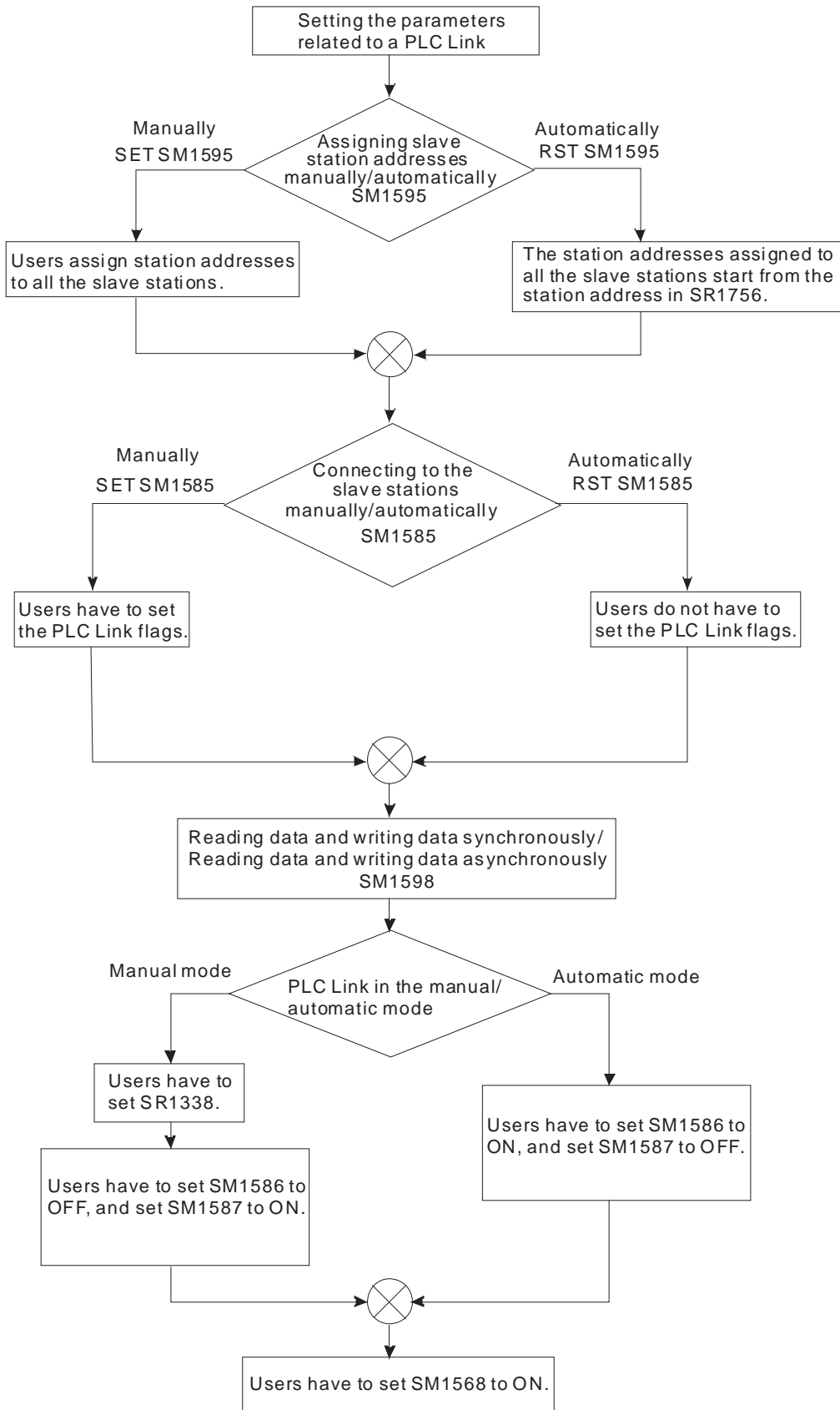

2. Example:

The master station AHCPU530-RS2 is connected to slave station 1 DVP28SV11T. The data in the device

addresses starting from D300 in slave station 1 is read into the device address starting from D100 in the master station. The number of data read from slave station 1 is 10. The data in the device addresses starting from D0 in the master station is written into the device addresses starting from D300 in slave station 1. The number of written into slave station 1 is 10. SM1598 is set to OFF, SM1595 is set to OFF, and SM1586 is set to ON. Users can check whether data exchange is preformed correctly by comparing the data in D0~D9 with the data in D100~D109 in the master station.

Method 1:

Users can set the parameters related to a PLC Link according to the process described above.

Step 1: Start ISPSoft, and write the program shown below. If M1 is turned ON, SM1586 and SM1584 will be ON.

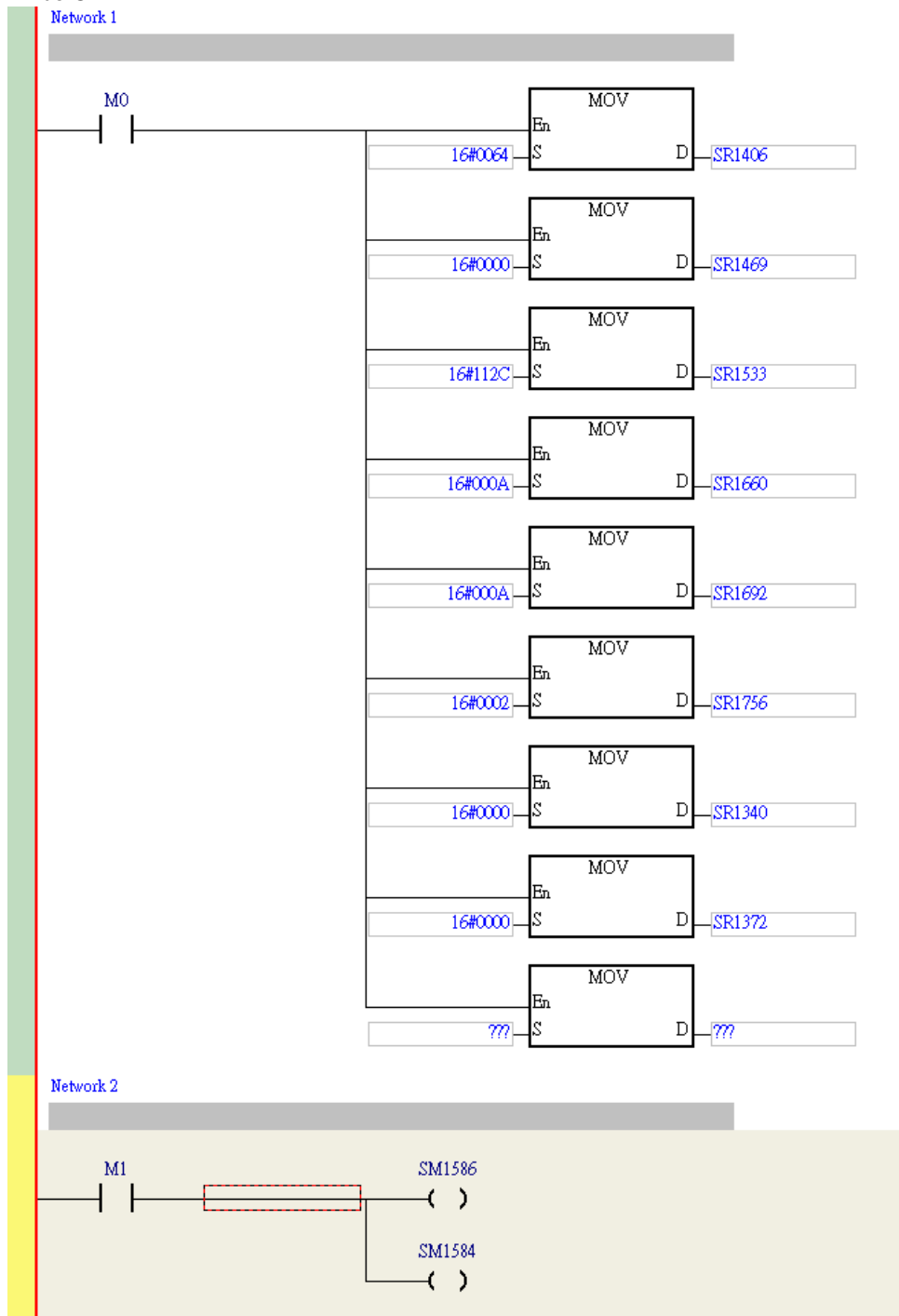

Step 2: Open the **Monitor Table** window in ISPSoft. Add M1, D0~D9, and D100~D109 to the window. Set

M1 to ON, and then set values for D0~D9. Users can check whether data exchange is performed correctly by comparing the data in D0~D9 with the data in D100~D109.

11

Device Name	Status	Data Type	Value (16 bits)
M1			
D0			11
D1			22
D2			33
D3			44
D4			55
D5			66
D6			77
D7			88
D8			99
D9			1010
D100			11
D101			22
D102			33
D103			44
D104			55
D105			66
D106			77
D107			88
D108			99
D109			1010

Method 2:

If users write a program, they will spend much time setting special data registers and special auxiliary relays. It is more convenient for users to construct a PLC Link by means of NWCONFIG in ISPSOft. (Please refer to section 11.1.2 for more information about NWCONFIG in ISPSOft.)

Step 1: After users double-click the RS-485 network in the **NWCONFIG** window, the **PLC Link Table Editor** window will appear. The users have to select **Station address 1 CPU530-RS2** in the **Master Device** drop-down list box.

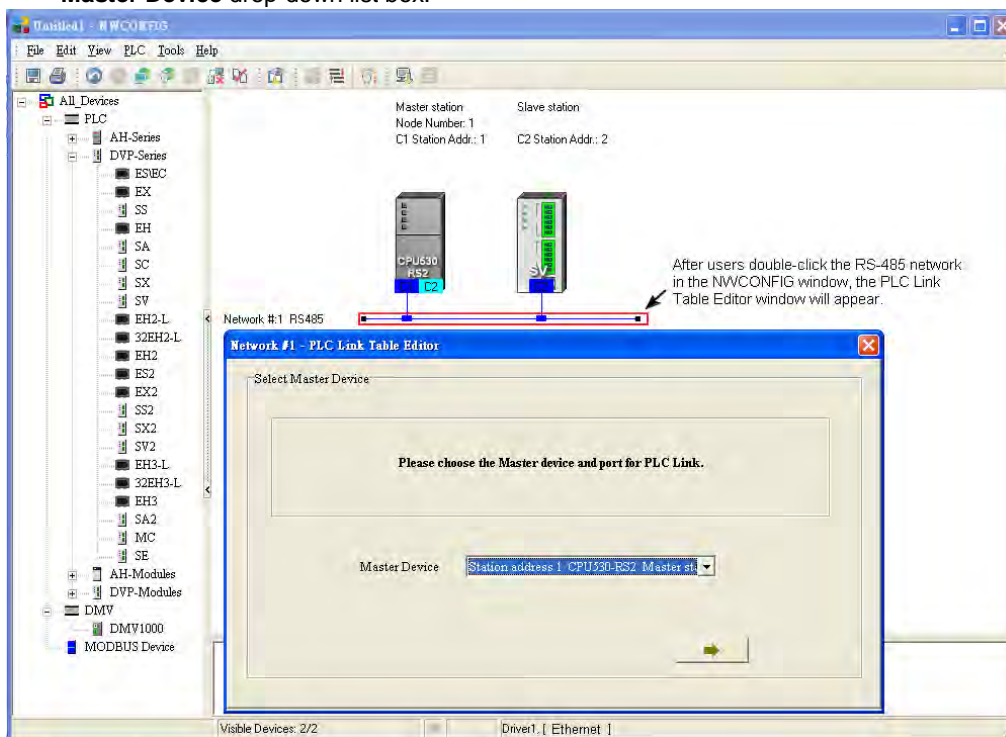

- Step 2:** The users have to click  until the system lead them to the third step.
- After the users double-click 2 in the **Station Addr.** cell, the **Parameter Setting** window will appear.
 - In the **Master Parameter Setting** section in the **Read** section, the users have to select **D** in the drop-down list box, type **100** in the **Starting Address** box, and type **10** in the **Data Length** box. In the **Slave Parameter Setting** section in the **Read** section, the users have to select **D** in the drop-down list box, and type **300** in the **Starting Address** box. In the **Master Parameter Setting** section in the **Write** section, the users have to select **D** in the drop-down list box, type **0** in the **Starting Address** box, and type **10** in the **Data Length** box. In the **Slave Parameter Setting** section in the **Write** section, the users have to select **D** in the drop-down list box, and type **300** in the **Starting Address** box.
 - After the parameters in the **Parameter Setting** window are set, the users can click **OK** in the **Parameter Setting** window, and click **Monitor and Download** in the **PLC Link Table Editor** window.

11

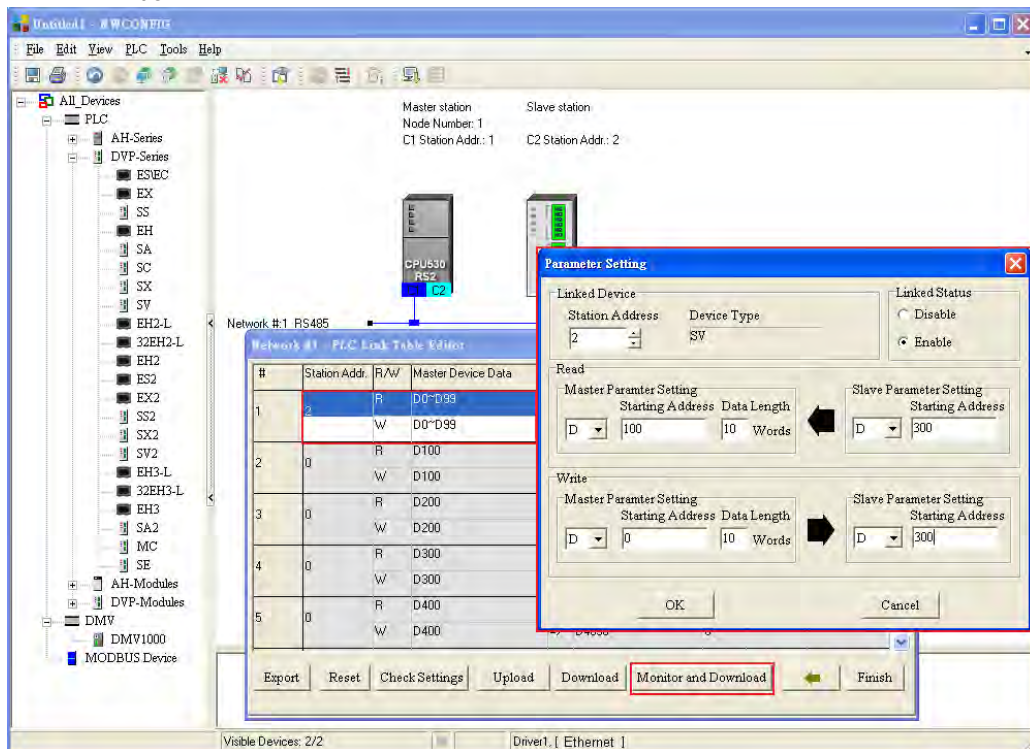

Step 3:

- A. After the users click ► in the **Linked Machines Status** window, ► will become ||.
- B. After the users right-click **(1) Addr.: 2**, they have to click **Write Register** on the context menu.
- C. The users have to type the values shown in the figure below in the **Input Value** window.

11

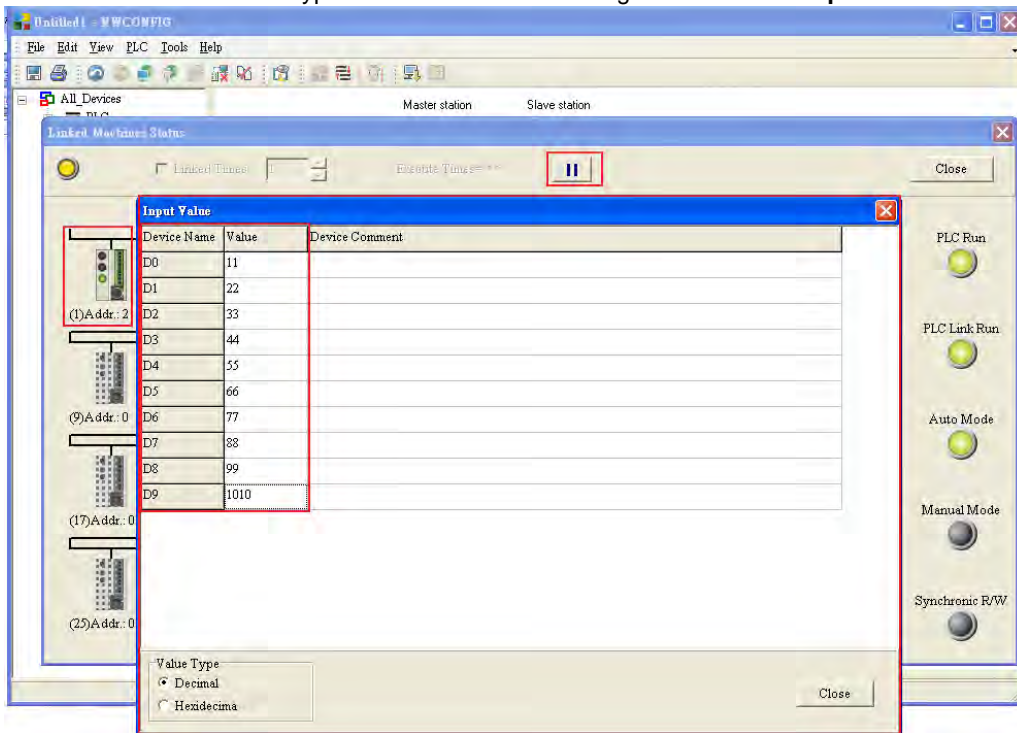

Step 4: The users have to right-click **(1) Addr.: 2**, and click **Read Register** on the context menu. The values in the **Input Value** window indicate that the data exchange is performed correctly.

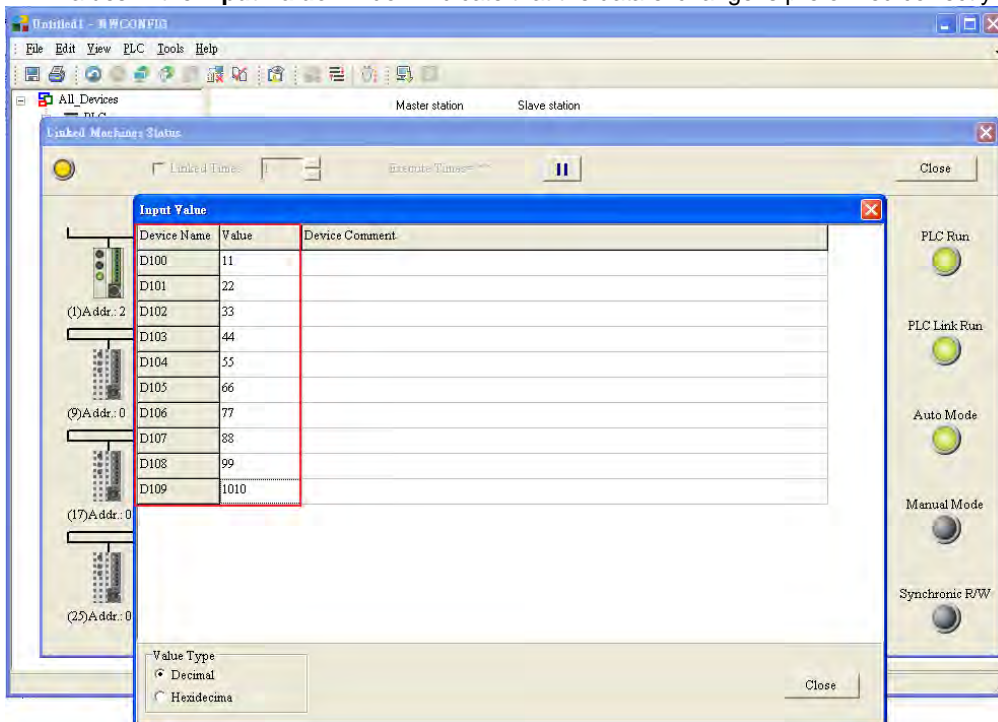

11.1.4 Related Special Auxiliary Relays and Special Data Registers

1. Descriptions of the related special auxiliary relays:

Device	Name	R/W	Description
SM1584	Enabling the function of executing a PLC Link	R/W	Executing a PLC Link OFF: The function of executing a PLC Link is disabled. (Default) ON: The function of executing a PLC Link is enabled.
SM1585	Connecting to the slave stations automatically/manually	R/W	Using user-defined PLC Link flags ^{**1} OFF: The user-defined PLC Link flags are not used. ON: The user-define PLC Link flags are used.
SM1586	Executing a PLC Link in the automatic mode	R/W	PLC Link in the automatic OFF: Not executing a PLC Link in the automatic mode (Default) ON: Executing a PLC Link in the automatic mode
SM1587	Executing a PLC Link in the manual mode	R/W	PLC Link in the manual mode OFF: Not executing a PLC Link in the manual mode (Default) ON: Executing a PLC Link in the manual mode
SM1588	Enabling the function of detecting the slave stations automatically	R	Detecting the slave stations OFF: The master does not detect the slaves. ON: The master station detects the slave stations.
SM1589	PLC Link error flag	R	If SM1586 and SM1587 are ON, SM1589 will be ON. OFF: No error occurs. ON: An error occurs.
SM1590	A device address is incorrect.	R	If a device address is incorrect, SM1590 will be ON. OFF: A device address is incorrect. ON: No device address is incorrect.
SM1591	Timeout	R	If there is a communication timeout, SM1591 will be ON. OFF: There is no communication timeout. ON: There is a communication timeout.
SM1592	The number of polling cycles in a PLC link is incorrect.	R	If the value in SR1338 is 0, SM1592 will be ON. OFF: The number of times the master station polls the slave station is correct. ON: The number of times the master station polls the slave stations is incorrect.
SM1593	Standard Modbus communication protocol/AH500 Modbus communication protocol	R/W	Selecting a communication protocol OFF: Standard Modbus communication protocol (Default) ON: AH500 Modbus communication protocol



Device	Name	R/W	Description
SM1594	Detecting the slave stations automatically	R/W	The master station will detect the slave stations automatically only if the execution of the PLC Link stops. OFF: The master station finishes detecting the slave stations, or waits to detect the slave stations. (Default) ON: The master station is detecting the slave stations.
SM1595	Assigning slave station addresses automatically/manually	R/W	OFF: The station addresses assigned to all the slave stations start from the station address in SR1756. (Default) ON: Users assign station addresses to all the slave stations.
SM1596	PLC Link error	R	If an error occurs when a PLC Link is executed, SM1596 will be ON. If no error occurs when a PLC Link is executed, SM1596 will be OFF. OFF: No error occurs. (Default) ON: An error occurs.
SM1597	Using an extension communication port	R/W	If SM1597 is ON, an extension communication port will be used to send a command. If SM1597 is OFF, a communication port on the master station is used to send a command. OFF: No extension communication port is used. (Default) ON: An extension communication port is used.
SM1598	Enabling the function of reading data and writing data synchronously	R/W	If SM1598 is ON, t If SM1598 is OFF, t OFF: The function of reading data and writing data synchronously is disabled. ON: The function of reading data and writing data synchronously is enabled.*2 °

- *1. If the master station automatically detects that the station address of a slave station is the same as its station address, it will not connect to the slave station.
- *2. If the reading of data and the writing of data are synchronous, the device type used for reading must be the same as the device type used for writing. Otherwise an error will occur.

2. Descriptions of the read-only devices SM1588~SM1592:

Device	Description
SM1588	When the master station detects the slave stations automatically, SM1588 is ON. When the master station finishes detecting the slave stations, SM1588 is OFF.
SM1589	If SM1586 and SM1587 are ON, SM1589 will be ON, and SM1584 will be OFF. If no error occurs when the PLC Link is executed again, SM1589 will become OFF automatically.
SM1590	If communication address error occurs when data exchange is performed, SM1590 will be ON. If no communication address error occurs when data exchange is performed, SM1590 will be OFF.
SM1591	If a timeout occurs when data exchange is performed, SM1591 will be ON. If no timeout occurs when data exchange is performed, SM1591 will be OFF.
SM1592	If the value in SR1338 is 0, SM1592 will be ON, and SM1587 will be OFF. If the value in SR1338 is a legal value when SM1587 is ON, or if the value in SR1338 is a legal value when SM1584 is ON, SM1592 will be OFF.

3. Descriptions of the special data registers SR1329~SR1338:

Device	Name	R/W	Description
SR1332	Remote backplane ID	R/W	The value in SR1332 indicates the remote backplane on which the RTU module used is installed. The value in SR1332 must be in the range of 1 to 8.
SR1333	Remote slot ID	R/W	The value in SR1333 indicates the remote slot in which the RTU module used is installed. The value in SR1333 must be in the range of 0 to 7.
SR1334	Extension communication port number	R/W	The value in SR1334 indicates the communication port used. The value in SR1334 must be 1 or 2.
SR1335	Cycle of a PLC Link	R	The value in SR1335 indicates the time it takes for the master station to detect all the slave stations. (Time unit: 1 millisecond) The value in SR1335 will be 0 if one of the following conditions occurs. 1. The master station is turned from OFF to ON. 2. The master station begins to runs, or stops running. 3. The master station finishes detecting all the slave stations for the first time. The value in SR1335 will remain unchanged if the function of enabling a PLC Link is disabled.
SR1336	Number of slave stations connected	R	Users can not set SR1336. The can only view the value in SR1336. Whenever a PLC Link is executed, the slave stations connected to the master station are count.
SR1337	Time for which data has been exchanged by means of a PLC link	R	The value in SR1337 indicates the number of times the master station exchanges data with all the slave stations. SR1337 can be used only if SM1587 is ON. If the execution of a PLC link stops, the value in SR1337 will not disappear. If the execution of a PLC link in the manual mode stops, the value in SR1337 will not disappear. If the value in SR1337 becomes the same as the value in SR1338, the execution of the PLC link in the manual mode will stop.
SR1338	Restricted time of the PLC link which is defined by users	R/W	Users can set the number of times the master station exchange data with all the slave stations. The value in SR1338 must be in the range of 1 to 65535. If the value in SR1338 is not in the range, it will not be changed automatically.

11.2 Ether Link (for AHCPU5X0 models)

This function is applicable for AH500 basic CPU module series (AHCPU500/510/520/530).

11.2.1 Introduction of an Ether Link

An Ether Link is a network mechanism for data exchange performed through an Ethernet connection. If there are several nodes in an Ethernet network, users can create a mechanism for data exchange in the network, and select a start mode. If the parameters which are set are downloaded to the PLCs in the network, the systems of the PLCs perform data exchange according to the start mode selected when the PLCs run. The users do not have to write a redundant program. Besides, only AH500 series CPU modules support Ether Links.

A PLC Link is a master/slave model. There is only one master station in an RS-485 network, and the other stations which are slave stations passively receive reading/writing commands from the master station. Compared with a PLC Link, an Ether Link adopts a safer data request mechanism. It is the data demanding nodes in an Ethernet network that execute an Ether Link.

An Ether Link is not a master/slave model. It allows a node to send reading commands which ask for data to other nodes. The nodes will send the data to the node after they receive the reading commands. Owing to the fact that a node can not send writing commands to other nodes, the use of an Ether Link is safer than the use of

a PLC Link. Besides, all the nodes in an Ethernet network can send reading commands through TCP/IP, and the system automatically manages the transmission of packets through TCP/IP. Compared with a PLC Link, an Ether Link is more efficient.

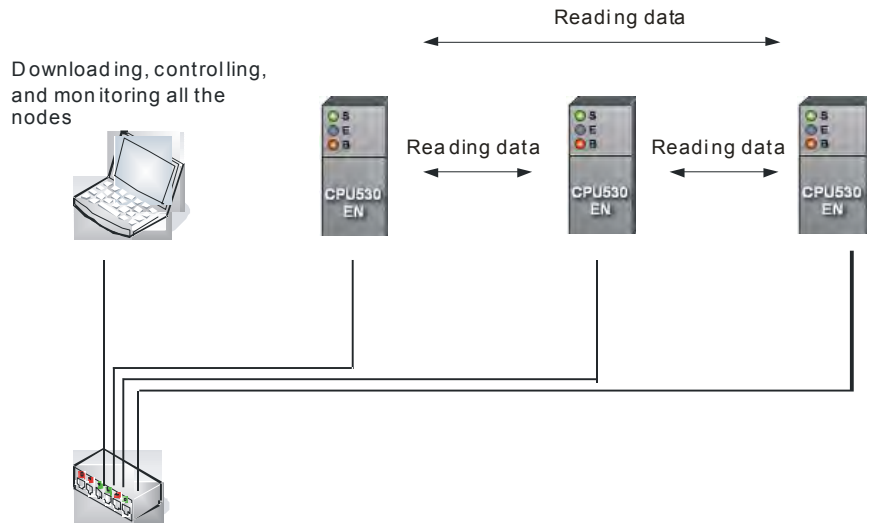

11.2.1.1 General Specifications and Functions

1. General specifications:

Item	Specifications
Communication type	Distribution
Data transfer rate	100 Mbps
Communication medium	Category 5 shielded cable
Maximum transfer distance	100 meters
Data storage	Relays (A word is taken as a unit.), data registers, and link registers
Number of storage blocks	Maximum of 128 blocks
Size of a storage block	Maximum of 1900 words
Modules supported	AHCPU530-EN, AH10EN-5A

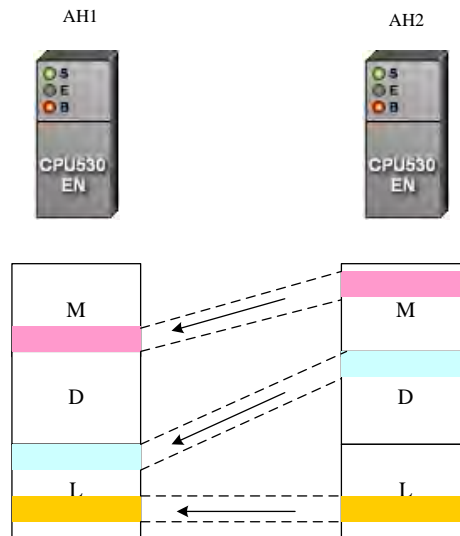

- Flexible control

There are three start modes.

 - (1) **Always Run**: When the PLC runs, data exchange is performed.
 - (2) **Always Stop**: During the operation of the PLC, no data exchange is performed.
 - (3) **SM Flag**: The performance of data exchange depends on a special auxiliary relay in the PLC. Users can set the start mode of an Ethernet port. They can operate an Ethernet port flexibly.
- Simple setting

Users can construct an Ether Link and a PLC Link by means of NWCONFIG in ISPSOft. After users create a network framework in NWCONFIG, they can create a data exchange table. Users can add devices and storage blocks which are involved in data exchange according to the actual framework. The setting can be downloaded to a PLC by the software. Users do not have to memorize registers.
- Elimination of errors

The execution of an Ether Link can be monitored by ISPSOft. Users can know the operating status of a PLC. The ports on a PLC and the storage blocks involved in data exchange are displayed. Besides, the error log displayed helps users eliminate errors.

11.2.1.2 Steps of Constructing an Ether Link

1. Plan a network architecture.
2. Connect PLCs to network cables according to the network architecture planned, and power the PLCs up.
3. Assign IP addresses and subnet masks to the Ethernet ports on the PLCs which will be involved in data exchange by means of HWCONFIG in ISPSOft. (The PLCs which will be involved in data exchange must be in the same domain.)
4. Create the network architecture planned in NWCONFIG in ISPSOft. Assign IP addresses and subnet masks to the machines which will be involved in data exchange. (Note: The IP addresses/subnet masks assigned in HWCONFIG and the IP addresses/subnet masks assigned in NWCONFIG must be the same. Otherwise an error will occur if the Ether Link constructed in NWCONFIG is executed.)
5. Create a data exchange table. (Please refer to section 11.2.2 for more information.)
6. Download the data exchange table, and monitor the execution of the Ether Link constructed in NWCONFIG.
7. The construction of an Ether Link is finished.

11.2.2 Constructing an Ether Link in NWCONFIG in ISPSOft

11.2.2.1 Constructing an Ether Link

Please refer to the example below for more information. If users want to create an Ether Link shown below, they have to create a data exchange table for the two data request nodes AH-01 and AH-02.

- (a) AH-01 reads the data in D100~D109 in AH-02, and stores the data in D0~D9 in itself.
- (b) AH-02 reads the data in D200~D219 in AH-01, and stores the data in D110~D129 in itself.

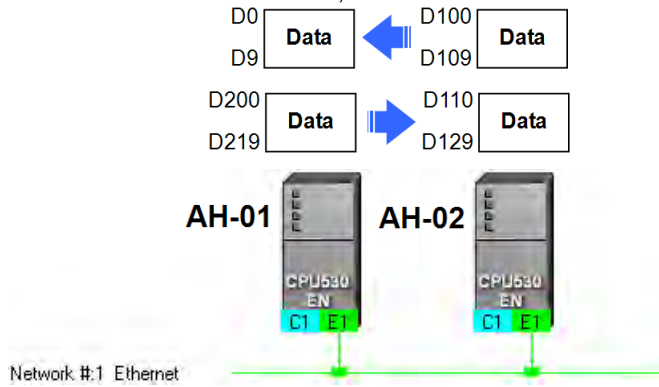

#	Device Name	Register	Starting Address	Range	<->	#	Device Na...	Register	Starting Address	Range	Size
1	AH-01	D	0	D0 ~ D9	<-	2	AH-02	D	100	D100 ~ D109	10
2	AH-02	D	110	D110 ~ D129	<-	1	AH-01	D	200	D200 ~ D219	20

An Ether Link is based on a network. If a node is connected to several networks, users can set several groups of parameters related to Ether Links for the networks. As a result, there may be several groups of parameters related to Ether Links in a PLC. Owing to the fact that an Ether Link is not a master/slave model, each node in a network can be a data demanding node and a data supply node at the same time. In the first piece of data in the table above, AH-01 is a data requiring node, and AH-02 is a data providing node. In the second piece of data in the table above, AH-01 is a data providing node, and AH-02 is a data requiring node.

11.2.2.2 Opening the Ether Link Configuration Window

Before users construct an Ether Link, they have to make sure that a network is set correctly. There are three ways to open the **Ether Link Configuration** window.

- **Method 1**

After the users select a network, they have to click **Construct Ether Link** on the **Tools** menu, or  on the toolbar.

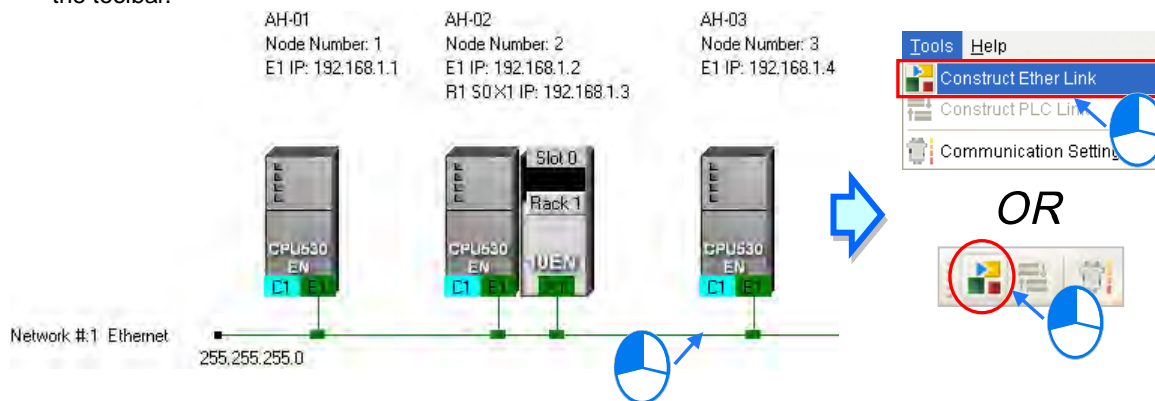

- **Method 2**
Double-click a network.

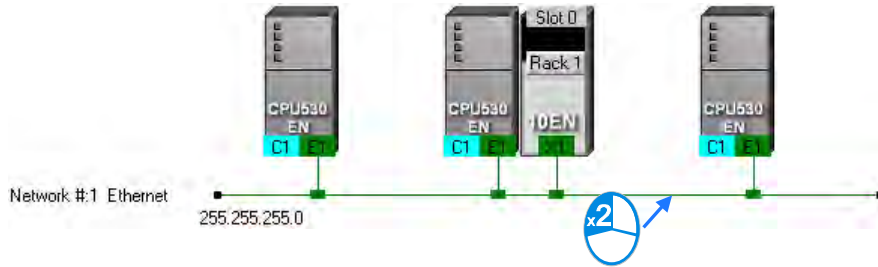

11

- **Method 3**
Right-click a network, and then click **Construct Ether Link** on the context menu.

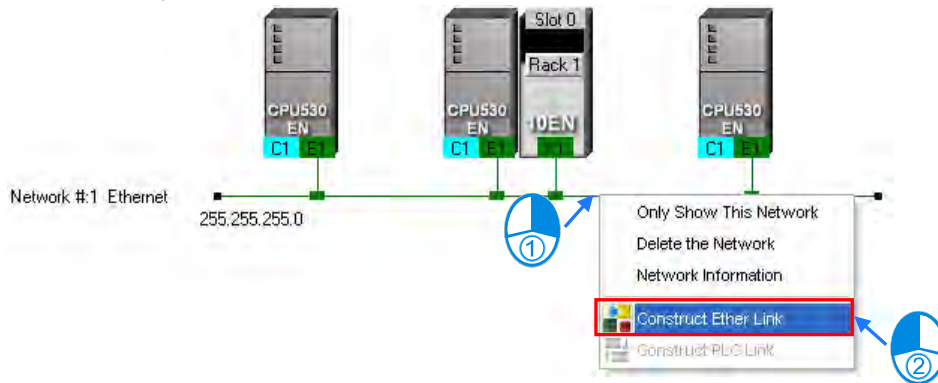

The **Ether Link Configuration** window is shown below.

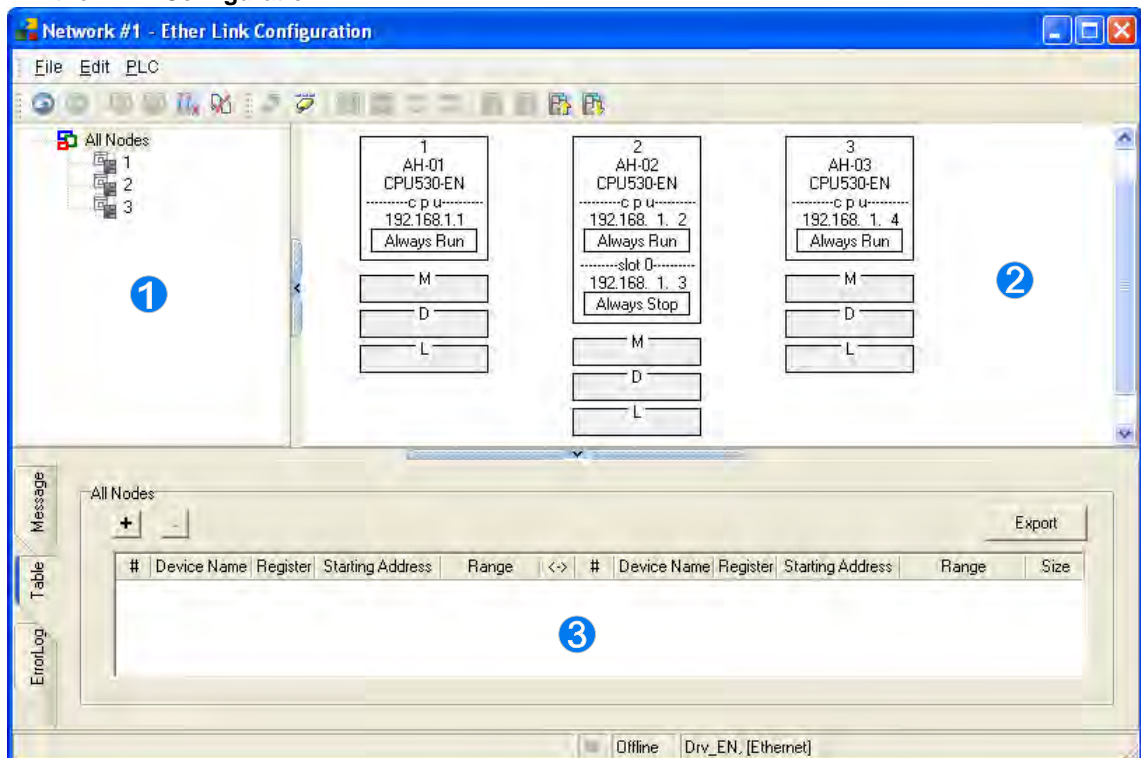

- ❶ **Node list:** After the users click a node, the node and the nodes of which the node demands data will be shown in the display area.
- ❷ **Display area:** The information about a node and the nodes of which the node demands data is displayed in this area.
- ❸ **Information area:** The users can click the **Message** tab, the **Table** tab, or the **Error Log** tab.

11

A node shown in the display area in the figure above is described below.

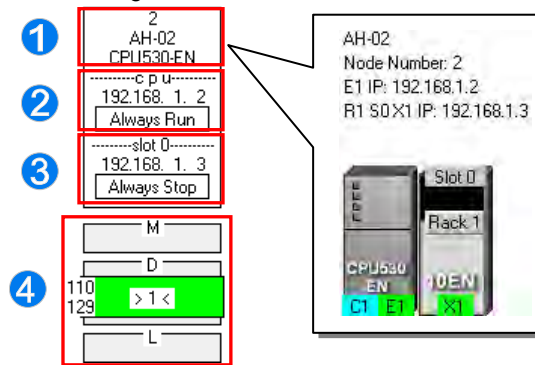

- ❶ The information is composed of a node number, a PLC name, and a model name.
- ❷ The IP address assigned to AH500 series CPU module is 192.168.1.2. The start mode of the Ether Link constructed is **Always Run**.
- ❸ The IP address assigned to the module installed in slot 0 is 192.168.1.3. The start mode of the Ether Link constructed is **Always Stop**.
- ❹ >1< in the D block indicates that the D block demands data of node 1. The numbers at the left side of the D block indicate that the data demanded of node 1 will be stored in D110~D119 in node 2. The color assigned to the D block depends on the node number in the D block. Owing to the fact that there is not any information in the M block and the L block, the M block and the L block does not demand any data of other devices.

11.2.2.3 Creating and Managing a Data Exchange Table

If users want to create a data exchange table, they have to click the **Table** tab in the information area. The node which is selected on the node list is shown in the upper left corner of the information area. The data in the table is related to the node selected.

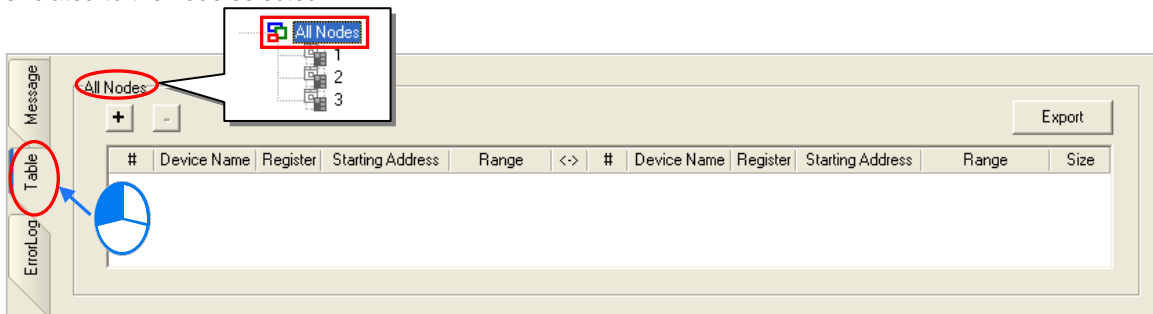

If the users click **+**, a new piece of data will be added to the table. A piece of data is composed of two parts. The left part of the data in the figure below indicates that the data demanding node AH-01 will store the data demanded in L0 in itself, and the right part of the data in the figure below indicates that the data supply node AH-02 will supply the data in L0 in itself.

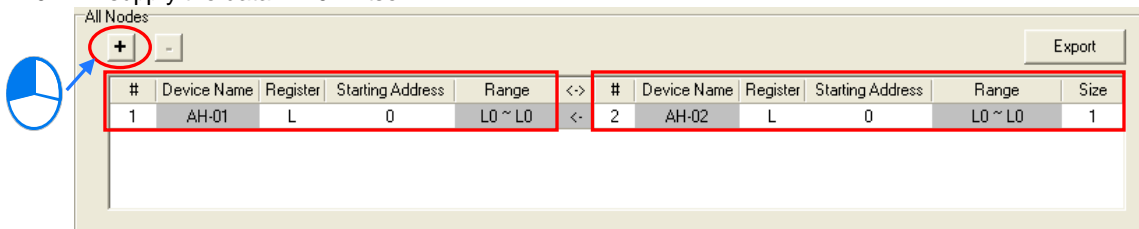

The steps of setting a data exchange group are as follows.

- (1) Select a node number in the # cell for the data demanding node. After the users select a node number, the PLC name corresponds to the node number will be appear in the **Device Name** cell for the node number.

#	Device Name	Register	Starting Address	Range	<->	#	Device Name	Register	Starting Address	Range	Size
1	AH-01	L	0	L0 ~ L0	<-	2	AH-02	L	0	L0 ~ L0	1

If the users select a specific node number rather than **All Nodes** on the node list, the data in the table will be related to the specific node number selected, and the fixed node number in the # cell for the data demanding node will be the specific node number selected on the node list.

#	Device Name	Register	Starting Address	Range	<->	#	Device Name	Register	Starting Address	Range	Size
1	AH-01	L	0	L0 ~ L0	<-	2	AH-02	L	0	L0 ~ L0	1

- (2) Select a device type in the **Register** cell for the data demanding node, and type an address in the **Starting Address** cell for the data demanding node.

#	Device Name	Register	Starting Address	Range	<->	#	Device Name	Register	Starting Address	Range	Size
1	AH-01	L	500	L500 ~ L500	<-	2	AH-02	L	0	L0 ~ L0	1

- (3) Select a node number in the # cell for the data supply node. The node number in the # cell for the data demanding node can not be the same as the node number in the # cell for the data supply node. After the users select a node number, the PLC name corresponds to the node number will be appear in the **Device Name** cell for the node number.

#	Device Name	Register	Starting Address	Range	<->	#	Device Name	Register	Starting Address	Range	Size
1	AH-01	D	500	D500 ~ D500	<-	2	AH-02	L	0	L0 ~ L0	1

- (4) Select a device type in the **Register** cell for the data supply node, and type an address in the **Starting Address** cell for the data supply node. The device type selected in the **Register** cell for the data supply node does not have to be the same as the device type selected in the **Register** cell for the data demanding node.

#	Device Name	Register	Starting Address	Range	<->	#	Device Name	Register	Starting Address	Range	Size
1	AH-01	D	500	D500 ~ D500	<-	2	AH-02	M	1000	M1000 ~ M1015	1

- (5) Type a data length in the **Size** cell. A word is a unit. The maximum data length is 1900 words. After the users type a data length, the device ranges in the **Range** cells will change according to the data length typed.

#	Device Name	Register	Starting Address	Range	<->	#	Device Name	Register	Starting Address	Range	Size
1	AH-01	D	500	D500 ~ D509	<-	2	AH-02	M	1000	M1000 ~ M1159	10

The users can create data exchange groups by following the steps described above. The device range in the

11

Range cell for a data demanding node can not overlap the device range in the **Range** cell for another data demanding node whereas the device range in the **Range** cell for a data supply node can overlap the device range in the **Range** cell for another data supply node. In other words, different demanders can ask for the same data, but different data can not be store in the same block.

#	Device Name	Register	Starting Address	Range	<->	#	Device Name	Register	Starting Address	Range	Size
1	AH-01	D	500	D500 ~ D509	<-	2	AH-02	M	1000	M1000 ~ M1159	10
1	AH-01	D	500	D500 ~ D509	<-	3	AH-03	D	100	D100 ~ D109	10
2	AH-02	L	0	L0 ~ L9	<-	3	AH-03	D	100	D100 ~ D109	10

If the users want to delete a piece of data, they can click the piece of data, and click .

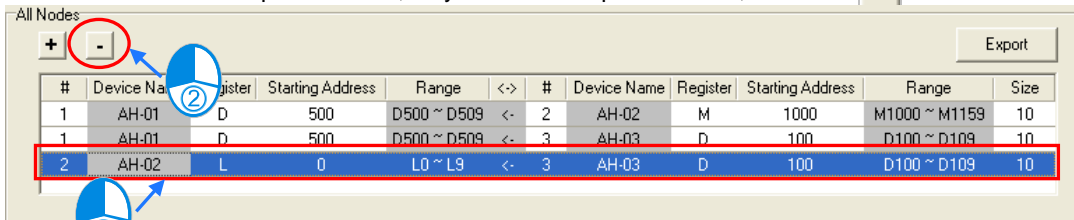

The screenshot shows the 'All Nodes' interface with a table. A red box highlights the minus icon (-) in the top left corner. A blue circle with the number 2 highlights the selected row (AH-02). A blue arrow points from the minus icon to the selected row.

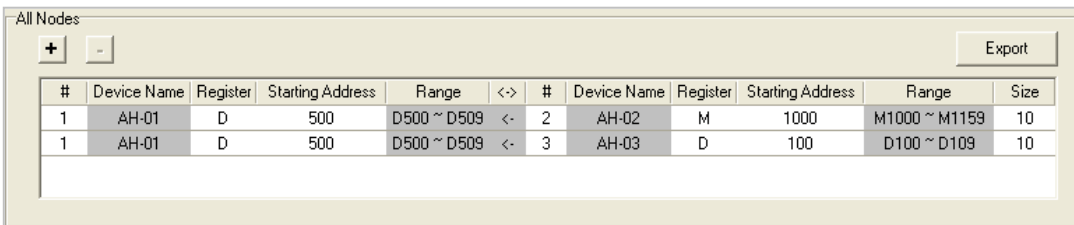

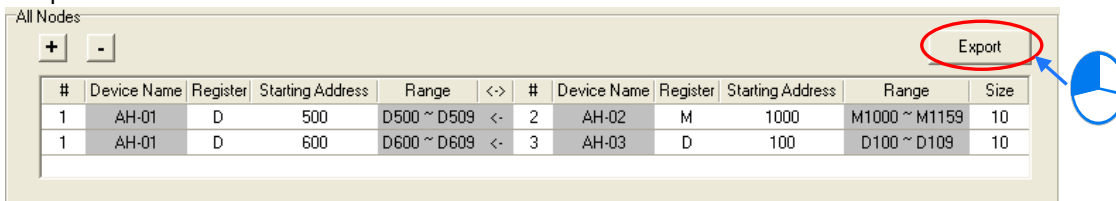

The screenshot shows the 'All Nodes' interface after deleting the selected row. The table now contains three rows: AH-01 (D, 500, D500 ~ D509), AH-01 (D, 500, D500 ~ D509), and AH-03 (D, 100, D100 ~ D109). The minus icon (-) is now visible in the top left corner.

After the users click **Export**, the data in the data exchange table can be exported as a CSV file. The users can edit the CSV file through Microsoft Excel. The CSV file can also be used as reference material for another development work.



The screenshot shows the 'All Nodes' interface with the 'Export' button highlighted by a red circle. A blue circle with an arrow points to the 'Export' button.

After the users create a data exchange table, they can click **Check Table Correctness** on the **Edit** menu or  on the toolbar if they want to check the data set in the table. The check result will be displayed in the **Message** page.

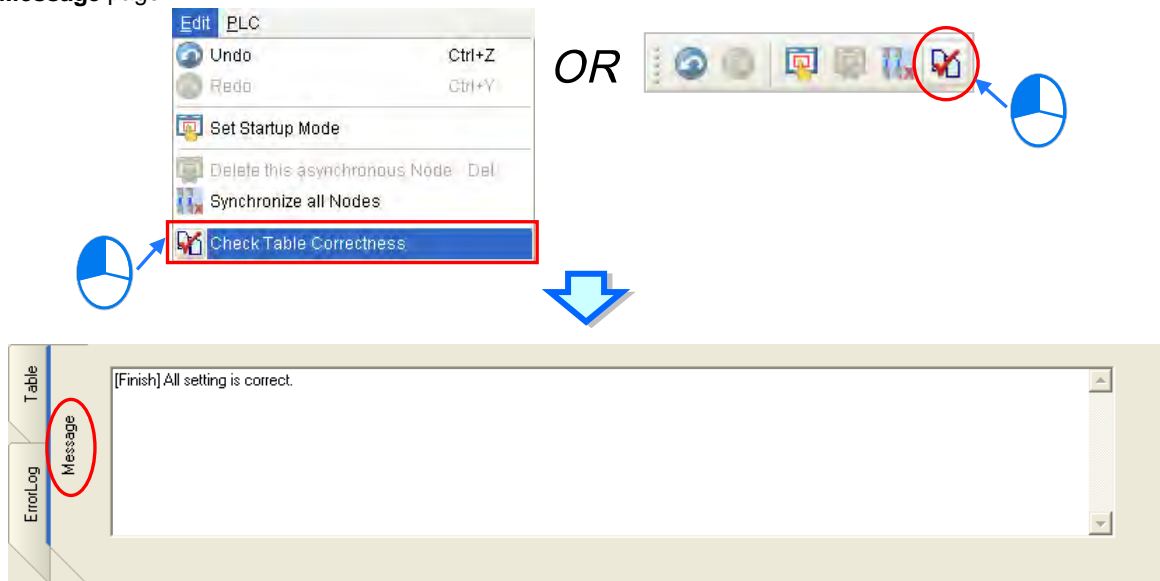

11

11.2.2.4 Node List and Display Area

If users click **All Nodes** on the node list, all the nodes will be displayed in the display area, and all the data exchange groups set will be in the data exchange table under the display area. Besides, the devices in which the data demanded will be stored, and the data supply nodes are indicated in device blocks of the nodes in the display area.

>2< in the D block in node 1 indicates that the D block demands data of node 2, and the numbers at the left side of the D block indicate that the data demanded of node 2 will be stored in D500~D509 in node 1. Likewise, >1< in the D block in node 2 indicates that the D block demands data of node 1, and the numbers at the left side of the D block indicate that the data demanded of node 1 will be stored in D1000~D1019 in node 1.

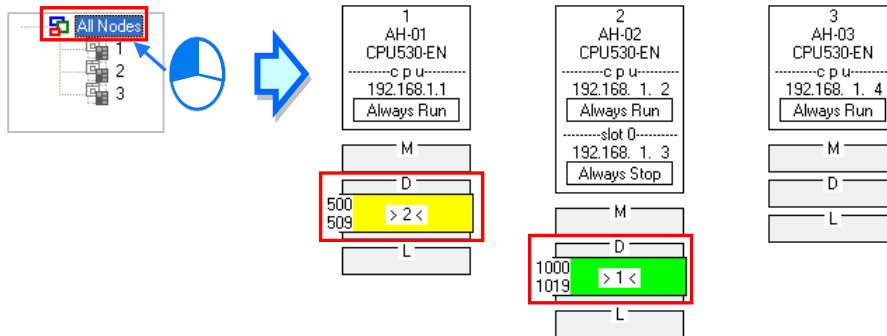

#	Device Name	Register	Starting Address	Range	<->	#	Device Name	Register	Starting Address	Range	Size
1	AH-01	D	500	D500 ~ D509	<-	2	AH-02	M	1000	M1000 ~ M1159	10
2	AH-02	D	1000	D1000 ~ D1019	<-	1	AH-01	L	0	L0 ~ L19	20

If the users click a specific node on the node list, the node and the nodes of which the node demands data will be shown in the display area, and the data in the data exchange table under the display will be related to the specific node selected.

11

In the figure below, the dotted frame indicates that node 1 on the node list is selected, and the gray ground indicates that node 2 is a data supply node. Node 2 can not be selected, and the information in the M block in node 2 indicates the data which will be supplied to node 1. Owing to the fact that node 3 does not supply any data to node 1, node 3 is not displayed in the display area.

The numbers at the left side of the D block in node 1 indicates that the data demanded of node 2 will be stored in D500~D509 in node 1. <1> in the M block in node 2 indicates that the data in M1000~M1129 in node 2 will be supplied to 1.

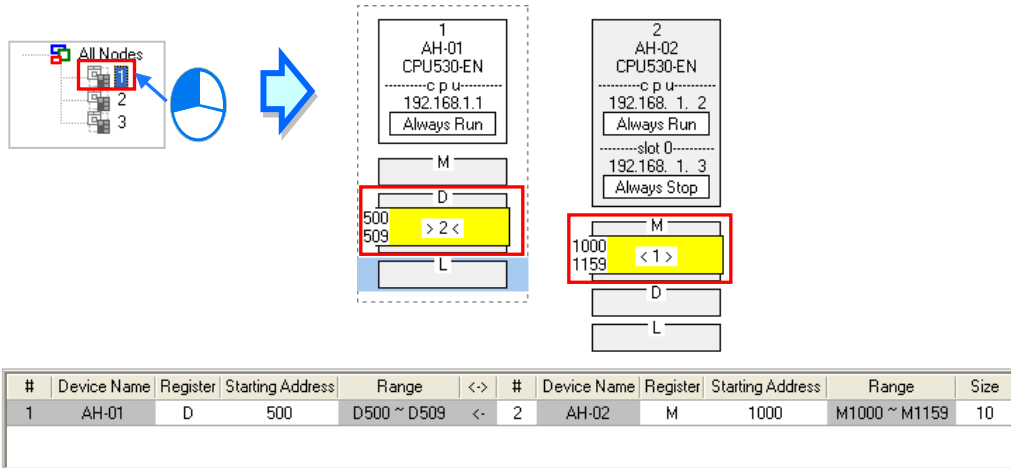

If a specific node on the node list is selected, the node in the display area will be selected. After the users select **All Nodes** on the node list, they can click the information about a node in the display area if they want to select the node. If the users click a device block in a node, the node will not be selected. After a node is selected, a dotted frame will appear.

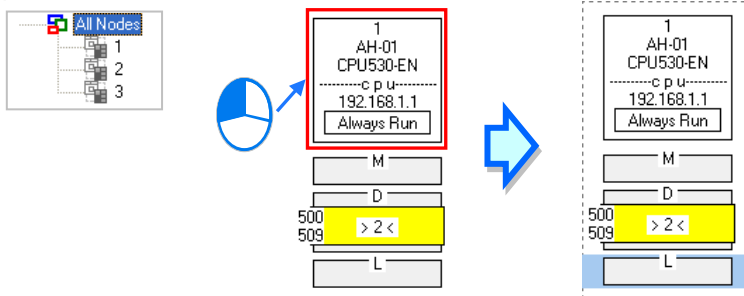

Once a node is selected, the node will be designated as a data demanding node. After the users click a device block in the node selected, a blue cursor will appear. After the users click a device block in another node (a data supply node), a green cursor will appear. The users can only click a device block in a data supply node. They can not select the node, otherwise the node will be designated as a data demanding node.

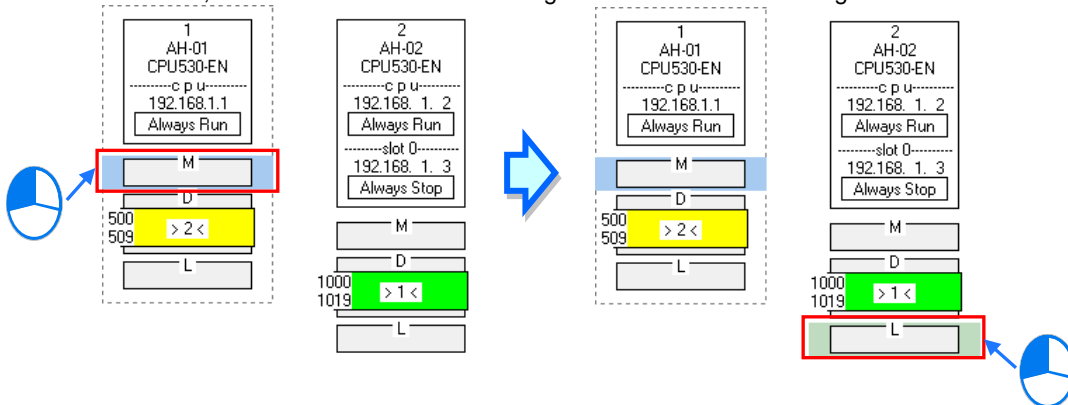

The users can click  to add a new piece of data to the data exchange table. The data includes the data demanding node, the node number assigned to the data demanding node, the data supply node, the node number assigned to the data supply node, and the device types selected. The users can refer to section 16.4.3,

and set the other cells.

#	Device Name	Register	Starting Address	Range	<->	#	Device Name	Register	Starting Address	Range	Size
1	AH-01	D	500	D500 ~ D509	<-	2	AH-02	M	1000	M1000 ~ M1159	10
2	AH-02	D	1000	D1000 ~ D1019	<-	1	AH-01	L	0	L0 ~ L19	20



#	Device Name	Register	Starting Address	Range	<->	#	Device Name	Register	Starting Address	Range	Size
1	AH-01	D	500	D500 ~ D509	<-	2	AH-02	M	1000	M1000 ~ M1159	10
2	AH-02	D	1000	D1000 ~ D1019	<-	1	AH-01	L	0	L0 ~ L19	20
1	AH-01	M	0	M0 ~ M15	<-	2	AH-02	L	0	L0 ~ L0	1

11

11.2.2.5 Start Mode of an Ether Link

There are three start modes. Please refer to the table below for more information.

Start mode	Description
Always Stop	During the operation of the PLC, no data exchange is performed.
Always Run	When the PLC runs, data exchange is performed.
SM Flag	The performance of data exchange depends on a special auxiliary relay in the PLC. After users select SM Flag , they can set the initial state of the related special auxiliary relay.

*. Please refer to manuals or technical documents for more information about special auxiliary relays related to Ether Links.

The execution of an Ether Link is based on the nodes in a network. If some of the ports that a node has are connected to a network, users can set the start modes of the ports separately. When the Ether Link constructed is executed, the system automatically distributes reading/writing work to the ports according to the start modes of the ports. If a port is disconnected, the system will pass the work belonging to the port to another port.

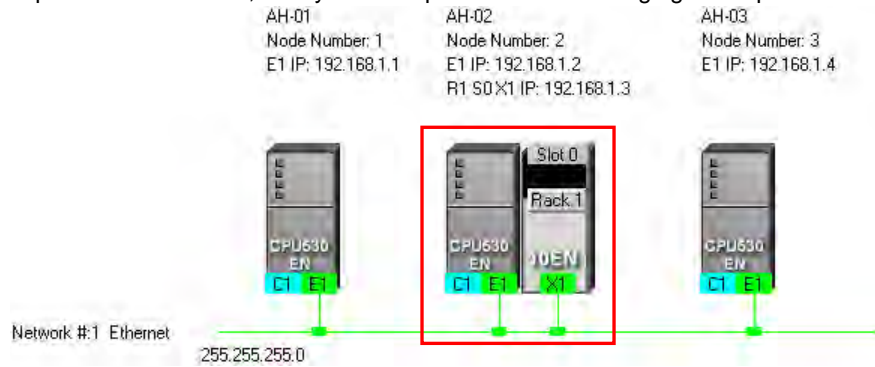

There are three ways to set the start mode of a node.

● **Method 1**

Right-click CPU information or module information, and then click **Set Startup Mode** on the context menu.

11

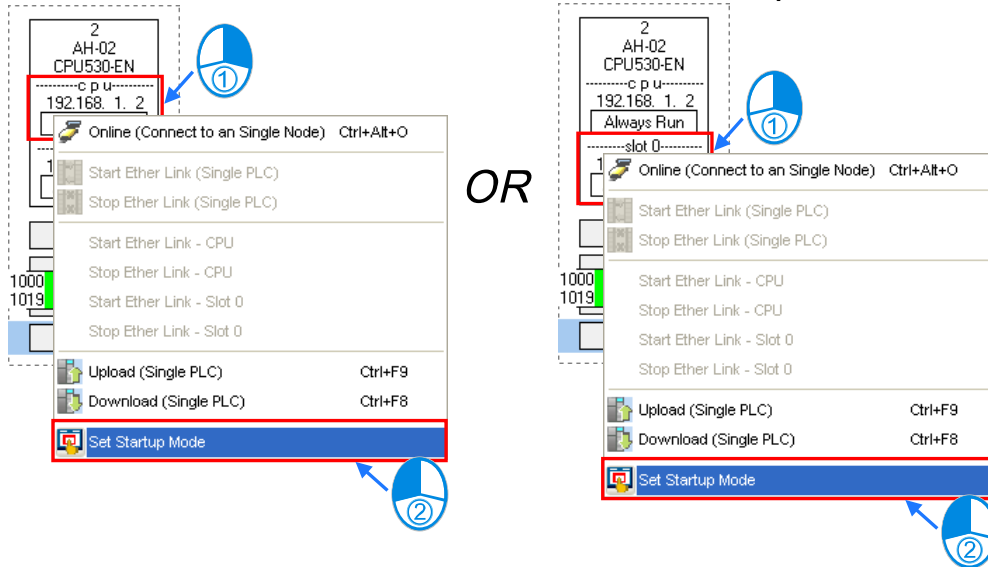

● **Method 2**

Double-click CPU information or module information.

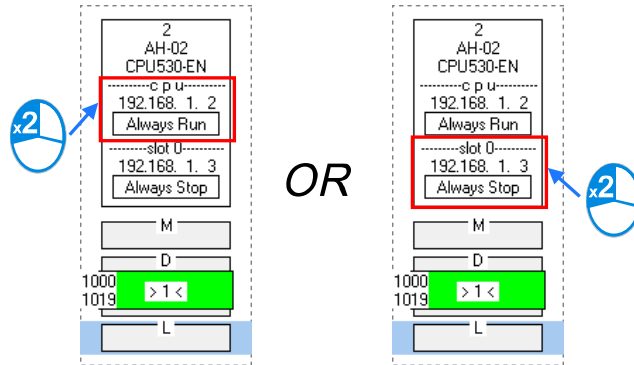

● **Method 3**

After the users click CPU information or module information, they have to click  on the toolbar, or **Set Startup Mode** on the **Edit** menu.

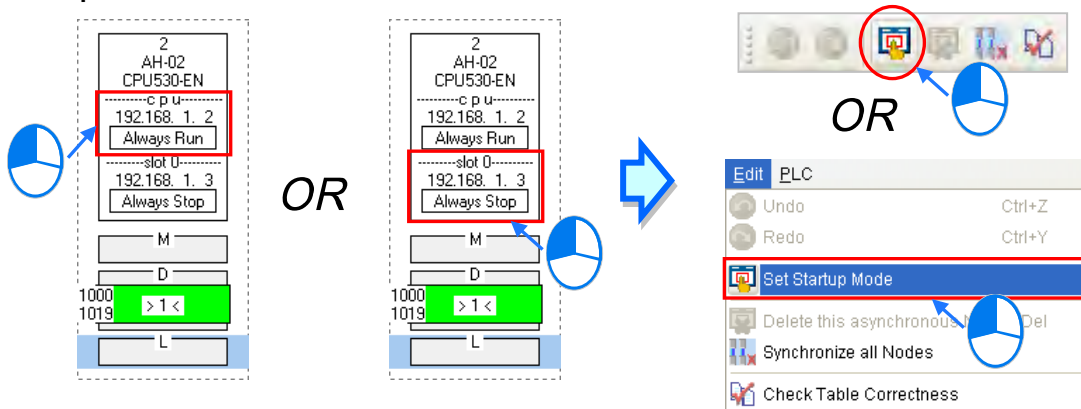

After the users use one of the methods described above, the Starting Mode Setup window will appear. The page displayed in the window varies with the information selected. The users can click the tabs in the window. Select a mode in the **Start Mode** drop-down list box. If **SM Flag** is selected, the users can select an initial state in the **Download State** drop-down list box. After an initial state is selected, the users can click **OK**.

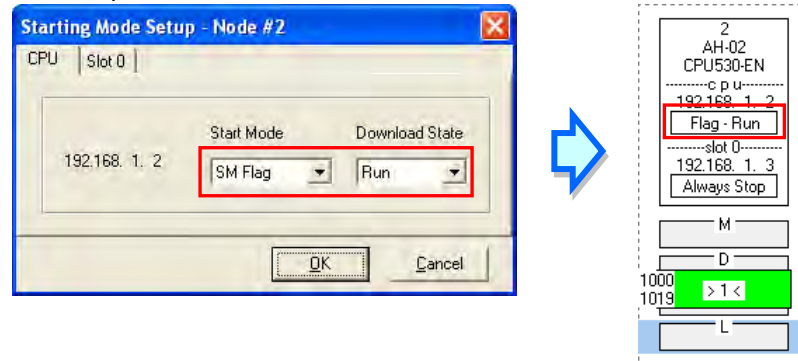

11

11.2.2.6 Downloading the Parameters Related to an Ether Link

After the parameters related to an Ether Link are set, users have to download the parameters to PLCs. The PLCs can perform data exchange after the parameters are downloaded.

- **Single node**

Only the data demanding setting related to the PLC selected, the start mode of the PLC selected, and the start modes of the modules connected to the PLC are downloaded. Before the users download the related parameters, they have to make sure that the system connects to the PLC normally, and they have completed the communication setting in NWCONFIG. Please refer to section 16.1.3 for more information.

- **Method 1**

Select a data demanding node, and then click  on the toolbar. The users can also download the related parameters by selecting a data demanding node, clicking the **PLC** menu, pointing to **Transfer**, and clicking **Download (Single PLC)**.

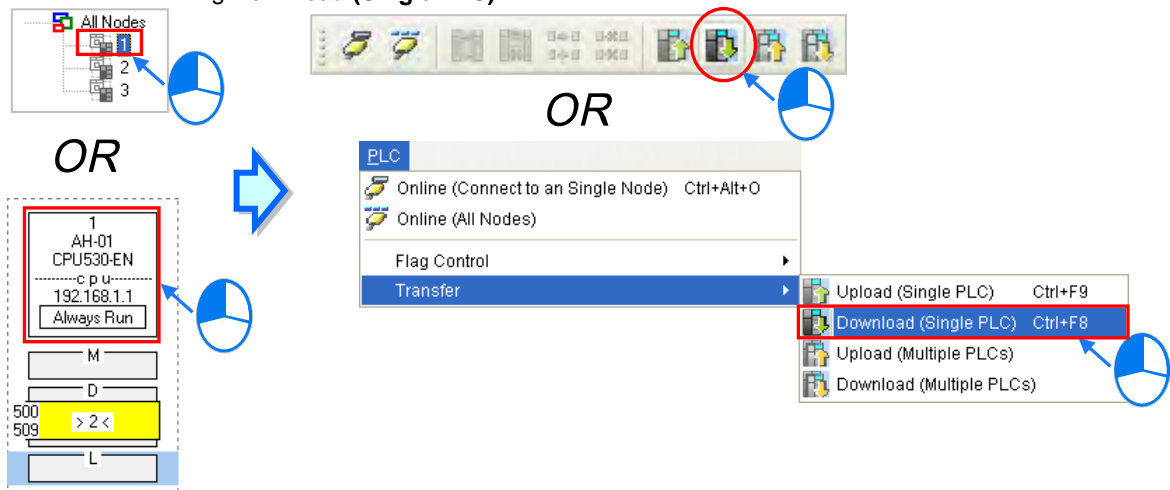

➤ **Method 2**

Select a data demanding node, right-click the data demanding node, and click **Download (Single PLC)** on the context menu.

11

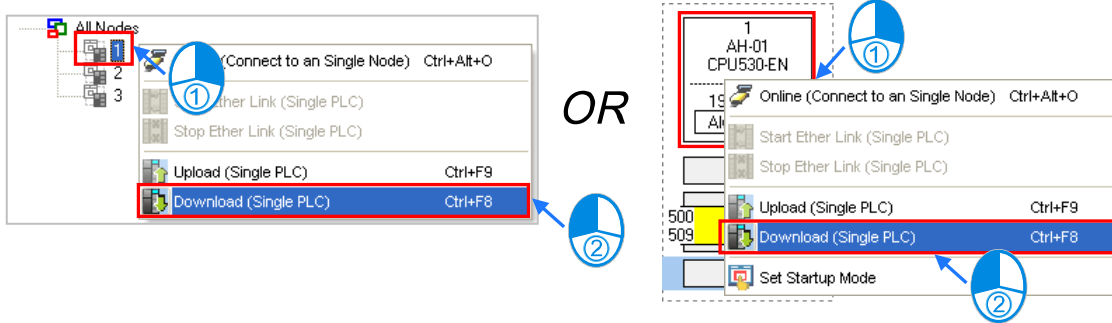

● **Multiple nodes**

The data demanding setting related to all the nodes, and the start modes of all the nodes are downloaded. Before the users download the related parameters, they have to make sure that all the PLCs and all the modules are connected to an Ethernet network, and can connect to NWCONFIG through Ethernet. The connection type that the driver selected in the **Driver Name** drop-down list box in the **Select a Driver** window uses must be Ethernet, otherwise the related parameters can not be downloaded. Please refer to section 16.1.3 for more information.

➤ **Method 1**

Click the **PLC** menu, point to **Transfer**, and click **Download (Multiple PLCs)**. The users can also download the related parameters by clicking  on the toolbar.

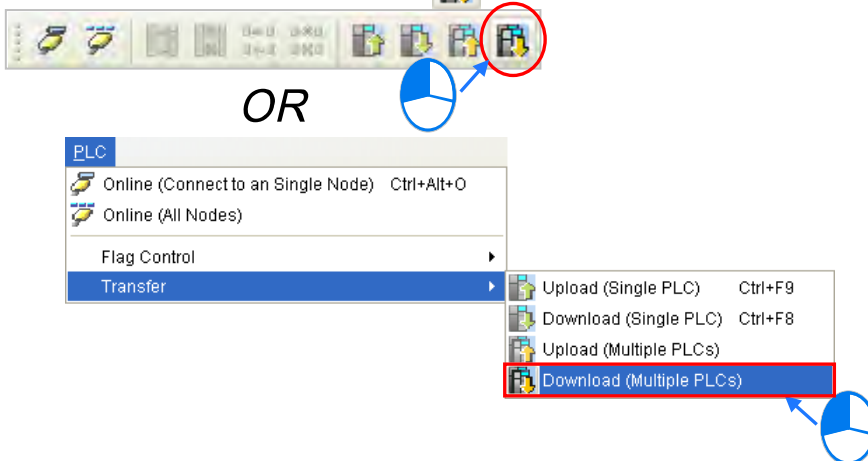

➤ **Method 2**

Select **All Nodes** on the node list, right-click **All Nodes**, and click **Download (Multiple PLCs)** on the context menu.

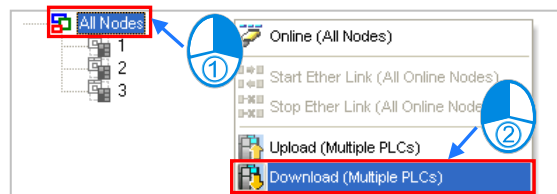

Additional remark

If the parameters set include a node which does not demand any data, the node will not demand any data through the network specified after the parameters are downloaded to multiple nodes.

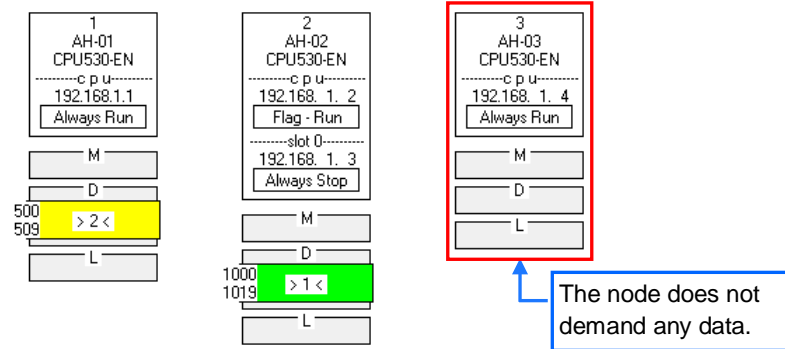

11

11.2.2.7 Uploading the Parameters Related to an Ether Link

Users can upload the parameters related to an Ether Link in a PLC.

● **Single node**

Only the parameters related to an Ether Link in the node selected are uploaded. Before the users upload the related parameters in a PLC, they have to make sure that the system connects to the PLC normally, and they have completed the communication setting in NWCONFIG. Please refer to section 16.1.3 for more information.

➤ **Method 1**

Select a data demanding node, and then click  on the toolbar. The users can also download the related parameters by selecting a data demanding node, clicking the **PLC** menu, pointing to **Transfer**, and clicking **Upload (Single PLC)**.

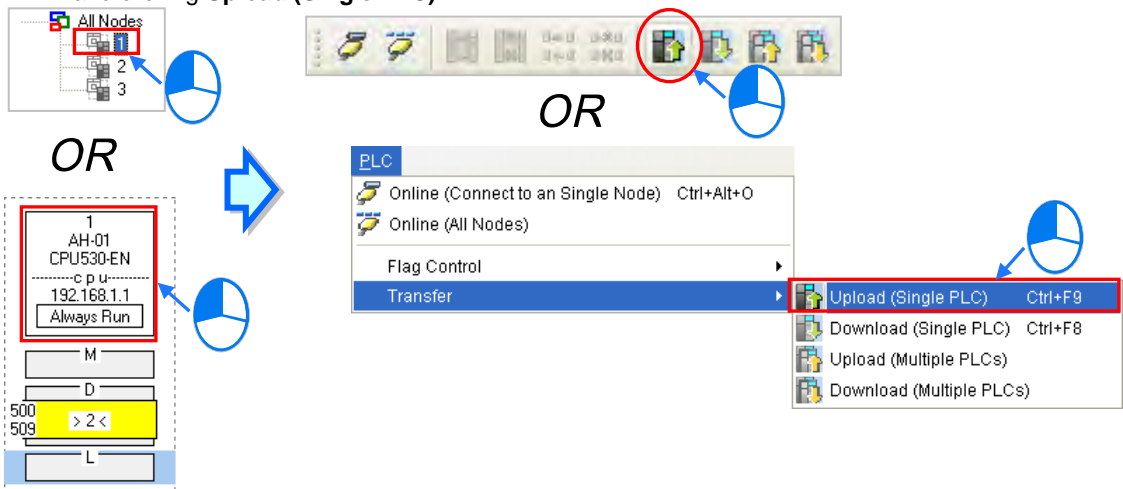

➤ **Method 2**

Select a data demanding node, right-click the data demanding node, and click **Upload (Single PLC)** on the context menu.

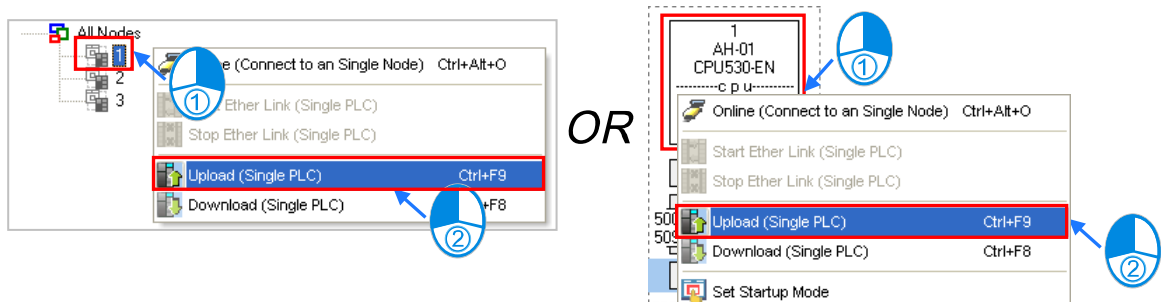

● **Multiple nodes**

The parameters related to an Ether Link in all the nodes are uploaded. Before the users upload the related parameters, they have to make sure that all the PLCs and all the modules are connected to an Ethernet network, and can connect to NWCONFIG through Ethernet. The connection type that the driver selected in the **Driver Name** drop-down list box in the **Select a Driver** window uses must be Ethernet, otherwise the related parameters can not be uploaded. Please refer to section 16.1.3 for more information.

➤ **Method 1**

Click the **PLC** menu, point to **Transfer**, and click **Upload (Multiple PLCs)**. The users can also download the related parameters by clicking  on the toolbar.

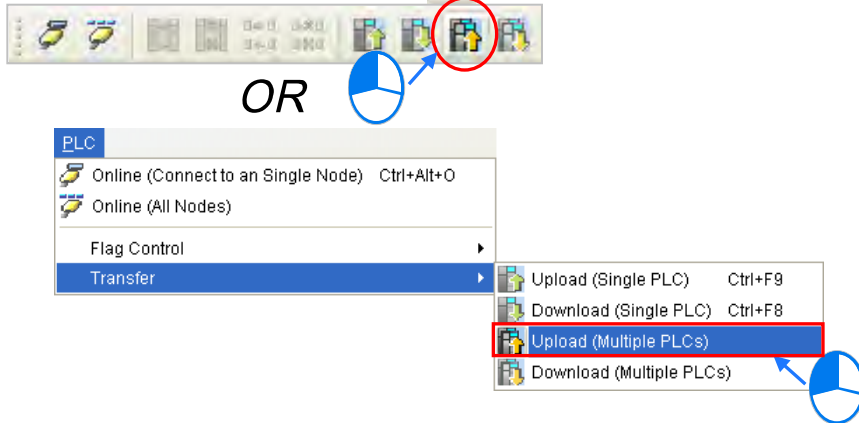

➤ **Method 2**

Select **All Nodes** on the node list, right-click **All Nodes**, and click **Upload (Multiple PLCs)** on the context menu.

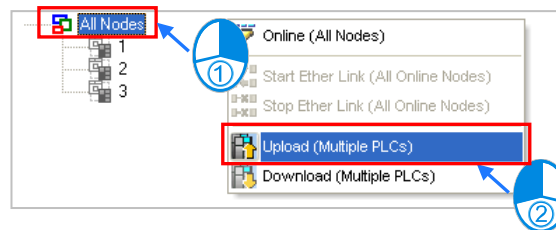

Additional remark

After the parameters which include a node not configured in NWCONFIG are uploaded, the node which is not configured in NWCONFIG will be called an asynchronous device, and will be in red. If the setting of an Ether Link includes an asynchronous device, the system does not allow the Ether Link to be monitored, and it does not allow the parameters related to the Ether Link to be downloaded.

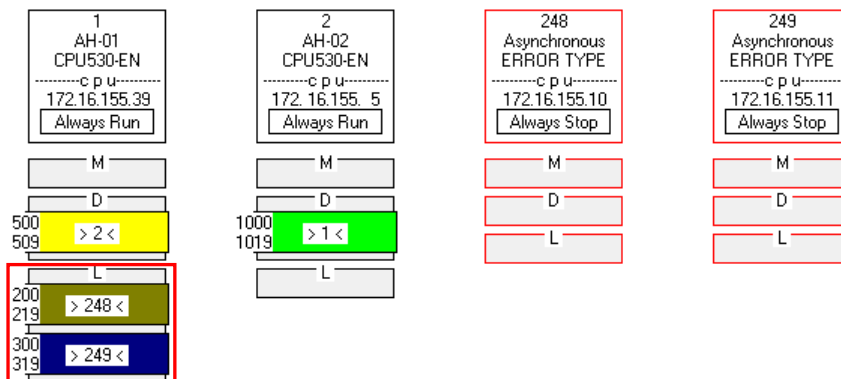

11.2.2.8 Deleting Asynchronous Device

If the setting of an Ether Link includes asynchronous devices, the system does not allow the Ether Link to be monitored, and it does not allow the parameters related to the Ether Link to be downloaded. Users have to find out the reason for the existence of the asynchronous devices. If the network configuration in NWCONFIG is incorrect, the users have to modify the network configuration, and upload the parameters related to the Ether

Link again. If the parameters uploaded are not applicable to the current network configuration, the users can delete the asynchronous devices.

Select an asynchronous device which will be deleted, and then click **Delete This Asynchronous Node** on the **Edit** menu, or  on the toolbar.

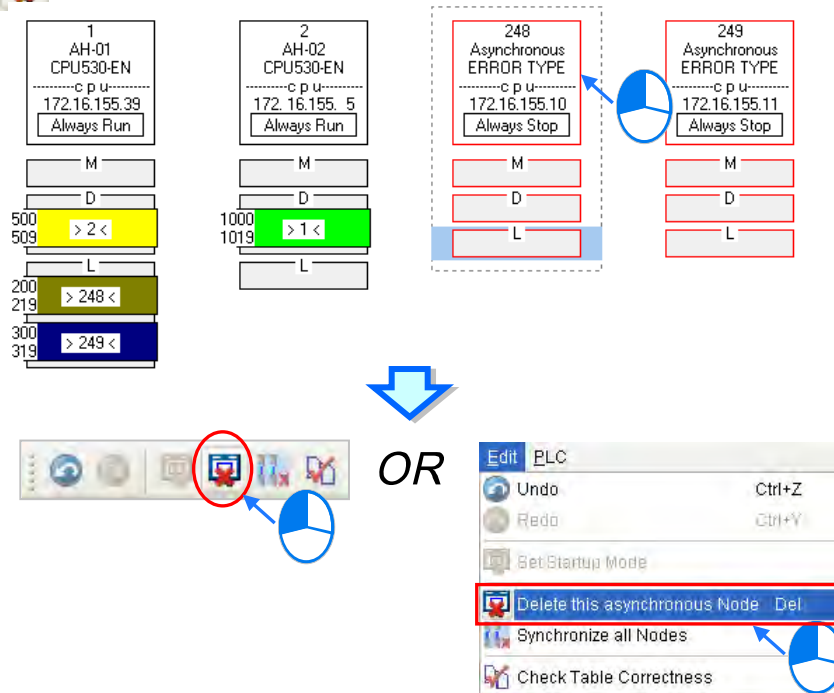

11

If the users want to delete all the asynchronous devices at the same time, they can click **Synchronize All Nodes** on the **Edit** menu, or  on the toolbar.

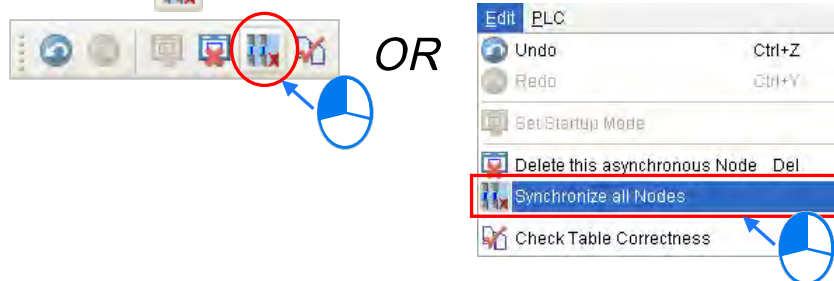

11.2.2.9 Enabling/Disabling the Online Monitoring Function

In the **Ether Link Configuration** window, users can execute or test the Ether Link constructed by means of the online monitoring functions provided by NWCONFIG. The users can enable/disable the function of monitoring a single node/multiple nodes online.

Enabling/Disabling		Description
Single node	Function	Enabling or disabling the function of monitoring the node selected online
	Condition	The users have to make sure that ISPSOft can connect to the PLC selected normally, and they have completed the communication setting in NWCONFIG.
Multiple nodes	Function	Enabling or disabling the function of monitoring all the nodes online
	Condition	The users have to make sure that all the nodes are connected to a network, and can connect to ISPSOft through Ethernet. The connection type that the driver selected in the Driver Name drop-down list box in the Select a Driver window uses must be Ethernet.

*. Please refer to section 16.1.3 for more information about the communication setting in NWCONFIG.

11

Before the users enable the online monitoring function, they have to make sure that all the nodes are connected according to the network framework created in NWCONFIG, and can operate normally.

- (a) Every node has been connected to a network according to the network framework created in NWCONIFG.
- (b) The users have set the parameters for Ethernet ports of the nodes by means of HWCOFNIG, and the parameters have been downloaded to the PLCs and the modules. The setting of the parameters must be consistent with the setting in NWCONFIG.
- (c) The parameters related to an Ether Link have been downloaded to the PLC selected.
- (d) Every node is powered up, and can operate normally.

A. Enabling a Monitoring Function

● **Enabling the function of monitoring a single node**

➤ **Method 1**

Select a data demanding node, and then click  on the toolbar, or **Online (Connect to a Single node)** on the **PLC** menu. When the data demanding node is monitored,  on the toolbar is pressed.

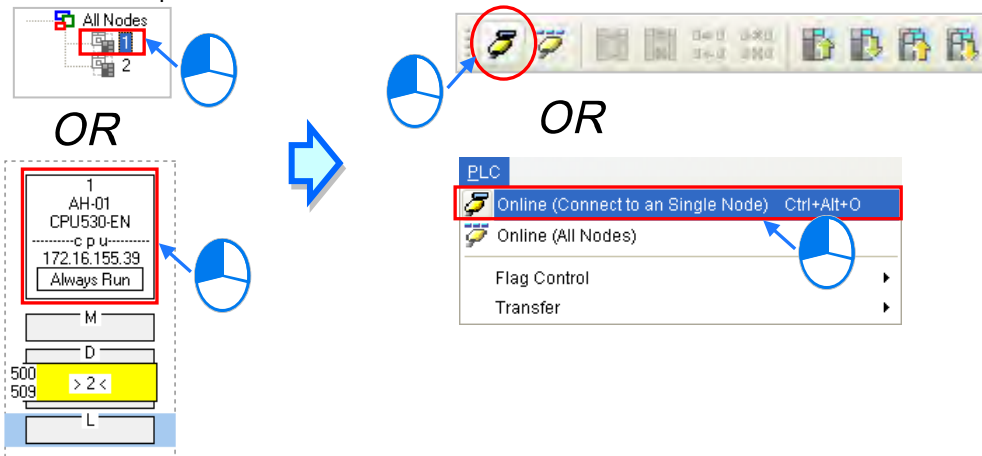

➤ **Method 2**

Select a data demanding node, right-click the data demanding node, and click **Online (Connect to a Single Node)** on the context menu. When the data demanding node is monitored,  on the toolbar is pressed.

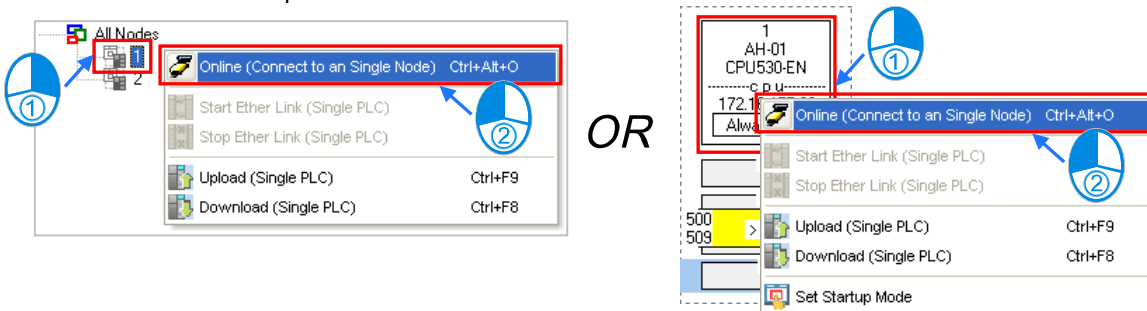

● **Enabling the function of monitoring multiple nodes**

➤ **Method 1**

Click **Online (All Nodes)** on the **PLC** menu, or  on the toolbar.

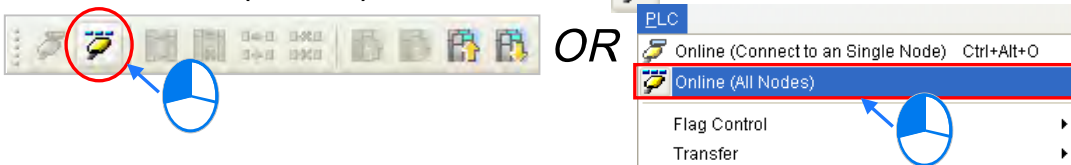

➤ **Method 2**

Select **All Nodes** on the node list, right-click **All Nodes**, and click **Online (All Nodes)** on the context menu.

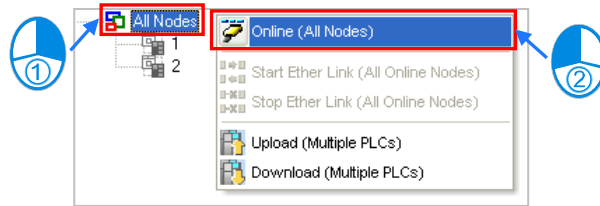

11

Additional remark

Before the system enters a monitoring mode, it checks whether the Ether Link constructed in the **Ether Link Configuration** window is consistent with the setting in the PLCs. If the Ether Link constructed in the **Ether Link Configuration** window is not consistent with the setting in the PLCs, the system will ask the users to download the related parameters again.

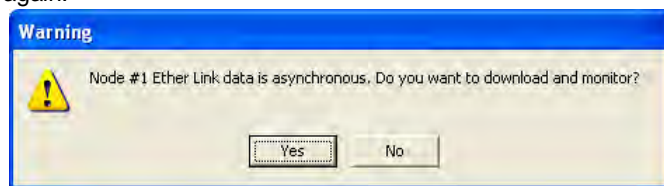

B. Monitoring Statuses

After the system enters a monitoring mode, the node which is monitored will be colored on the node list.

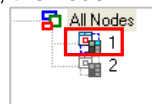

Besides, the words and the pictures in the display area will indicate the execution status of the current Ether Link after the system enters a monitoring mode.

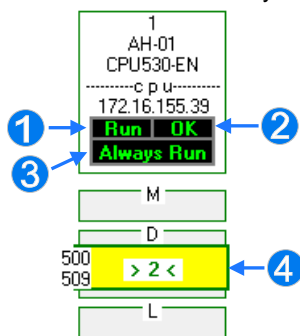

Status	Description
① Running/Stopping	Run : The Ether Link constructed is executed.
	Stop : The Ether Link is not executed.
② Operating status	OK : The Ether Link constructed is executed normally.
	Error : The Ether Link constructed is not executed normally.
③ Start mode	Always Stop : Always Stop
	Always Run : Always Run
	Flag Mode : SM Flag
④ Data block	500 > 2 < 509 : The data exchange is being performed.
	500 ≠ 2 ≠ 509 : The performance of the data exchange stops.

11

C. Disabling a Monitoring Function

● **Disabling the function of monitoring a single node**

➤ **Method 1**

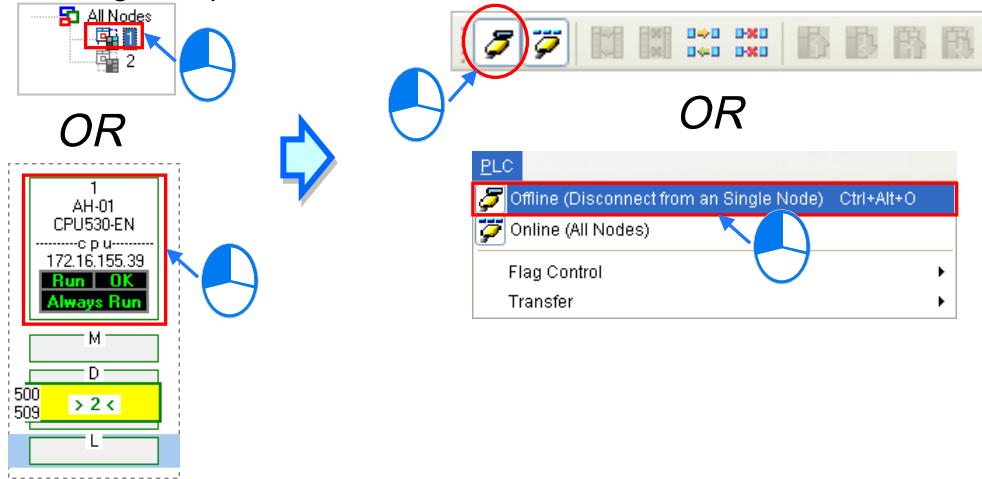

Select a data demanding node, and then click  on the toolbar, or **Offline (Disconnect from a Single node)** on the PLC menu.

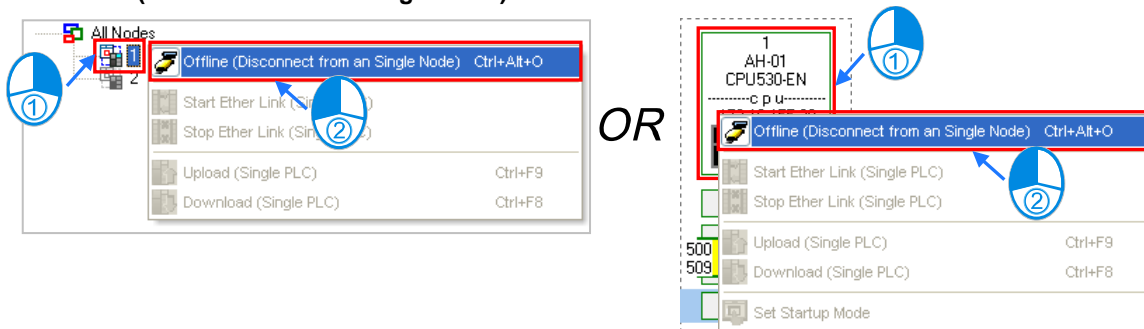

➤ **Method 2**

Select a data demanding node, right-click the data demanding node, and click **Offline (Disconnect from a Single Node)** on the context menu.



When the data demanding node selected is not monitored,  on the toolbar is not pressed. If another node is monitored,  will be pressed.

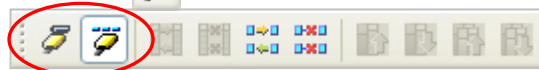

● **Disabling the function of monitoring multiple nodes**

➤ **Method 1**

Click **Online (All Nodes)** on the PLC menu, or  on the toolbar.

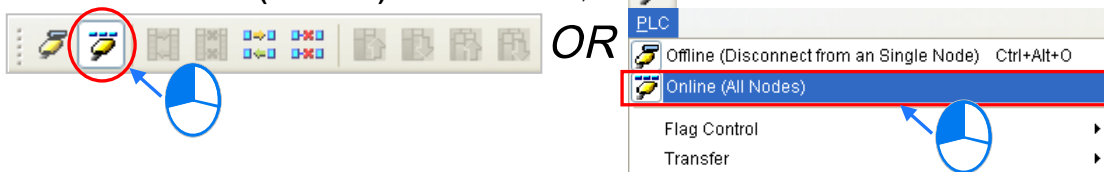

➤ **Method 2**

Select **All Nodes** on the node list, right-click **All Nodes**, and click **Online (All Nodes)** on the context menu.

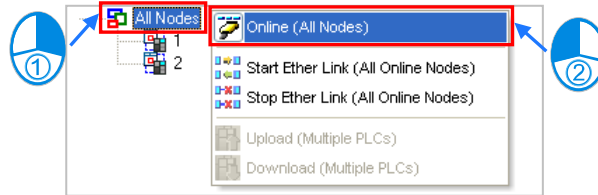

11

11.2.2.10 Starting/Stopping the Execution of an Ether Link Online

If the start mode of a node is **SM Flag**, users can make the node start or stop the execution of the Ether Link constructed by means of controlling the state of the related flag when the node is monitored online. If the node is not monitored online, the users can not make the node start or stop the execution of the Ether Link constructed by means of controlling the state of the related flag.

Users can make a single node/multiple nodes start or stop the execution of the Ether Link constructed. The conditions for making a single node/multiple nodes start or stop the execution of the Ether Link constructed are the same as the conditions for enabling/disabling the function of monitoring a single node/multiple nodes online. Please refer to section 11.2.2.9 for more information.

A. Starting the Execution of an Ether Link

- **Making a single node start the execution of an Ether Link**

➤ **Method 1**

If users want to make a node start the execution of the Ether Link constructed, they have to select the node, and click  on the toolbar. They can also make the node start the execution of the Ether Link constructed by selecting the node, clicking the **PLC** menu, pointing to **Flag Control**, and clicking **Start Ether Link (Single PLC)**.

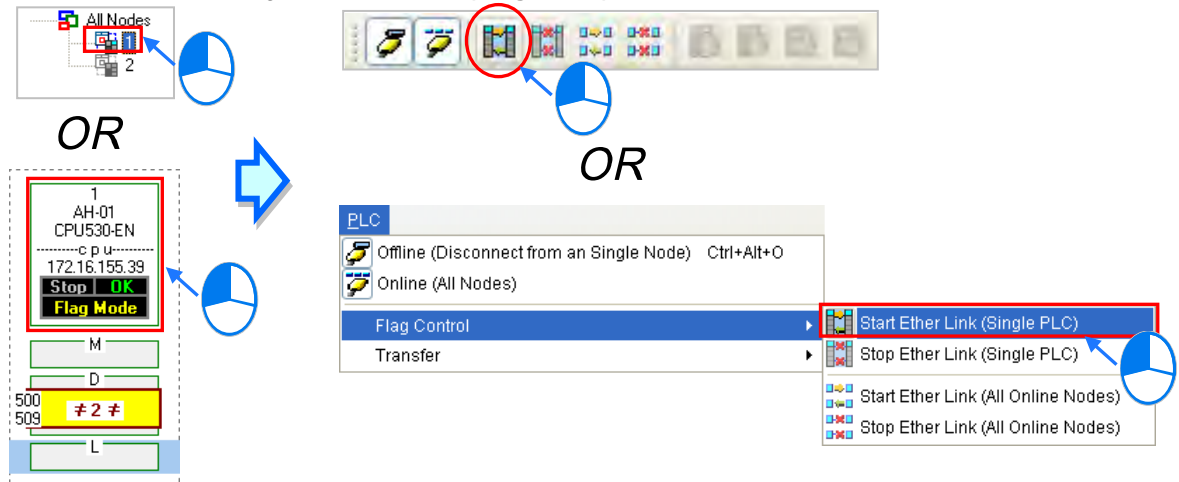

➤ **Method 2**

Select a node, right-click the node, and click **Start Ether Link (Single PLC)** on the context menu.

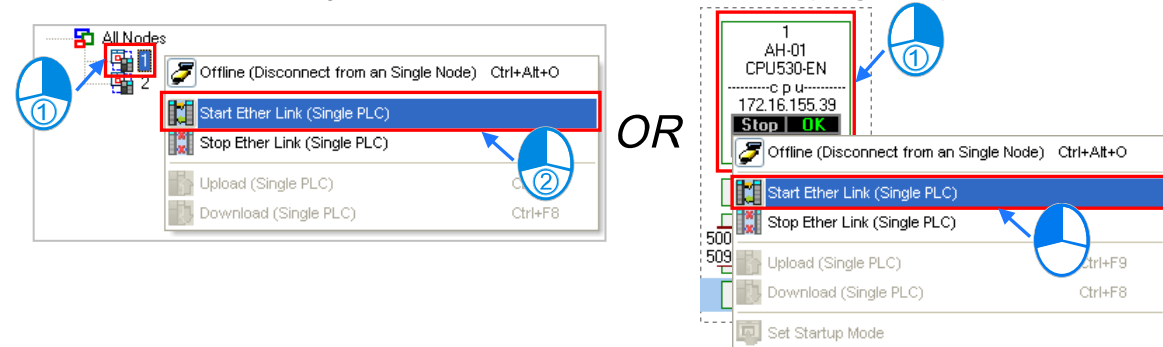

● **Making multiple nodes start the execution of an Ether Link**

➤ **Method 1**

If users want to make all the nodes start the execution of the Ether Link constructed, they have to click the **PLC** menu, point to **Flag Control**, and click **Start Ether Link (All Online Nodes)**. The users can also make all the nodes start the execution of the Ether Link constructed by clicking  on the toolbar.

11

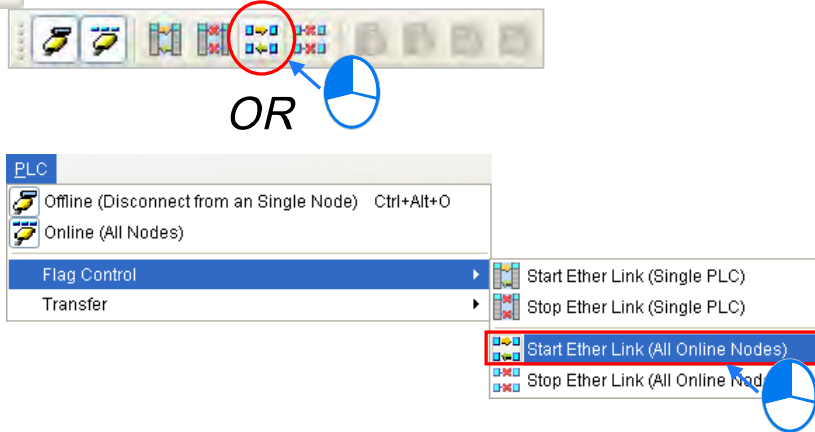

➤ **Method 2**

Select **All Nodes** on the node list, right-click **All Nodes**, and click **Start Ether Link (All Online Nodes)** on the context menu.

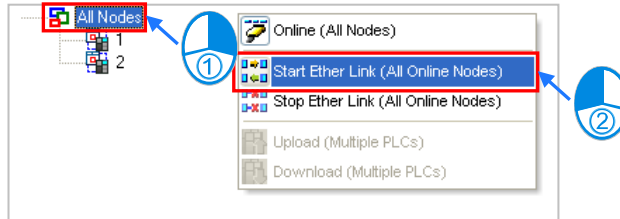

B. Stopping the Execution of an Ether Link

● **Making a single node stop the execution of an Ether Link**

➤ **Method 1**

If users want to make a node stop the execution of the Ether Link constructed, they have to select the node, and click  on the toolbar. They can also make the node stop the execution of the Ether Link constructed by selecting the node, clicking the **PLC** menu, pointing to **Flag Control**, and clicking **Stop Ether Link (Single PLC)**.

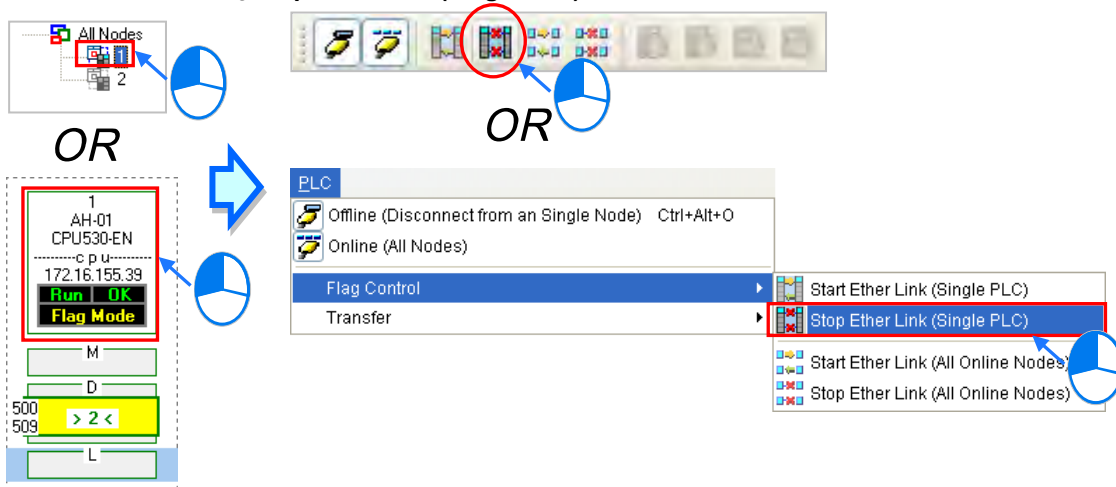

➤ **Method 2**

Select a node, right-click the node, and click **Stop Ether Link (Single PLC)** on the context menu.

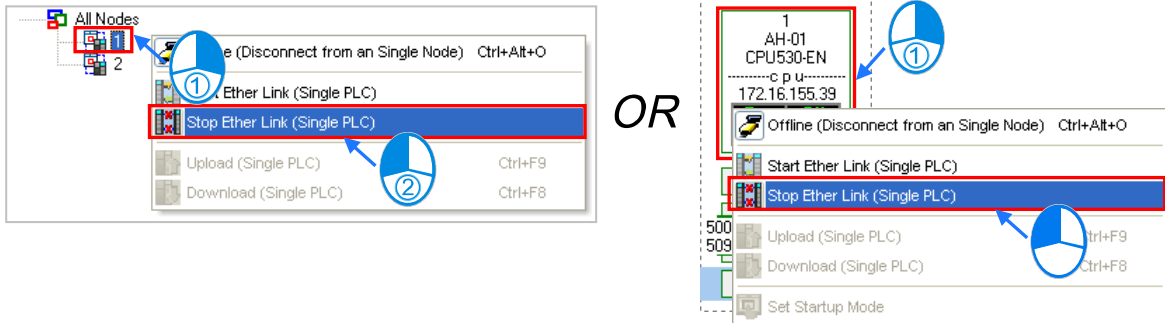

● **Making multiple nodes stop the execution of an Ether Link**

➤ **Method 1**

If users want to make all the nodes stop the execution of the Ether Link constructed, they have to click the **PLC** menu, point to **Flag Control**, and click **Stop Ether Link (All Online Nodes)**. The users can also make all the nodes stop the execution of the Ether Link constructed by clicking  on the toolbar.

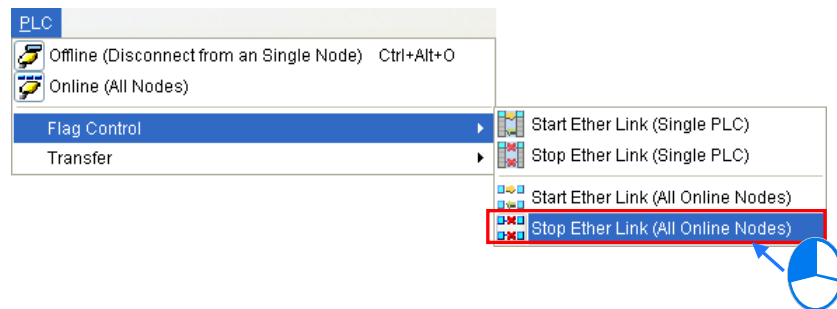

➤ **Method 2**

Select **All Nodes** on the node list, right-click **All Nodes**, and click **Stop Ether Link (All Online Nodes)** on the context menu.

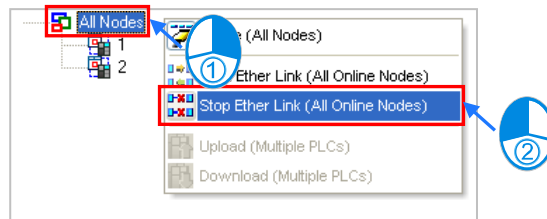

11

Additional remark

If a node in the display area has several Ethernet ports, users can make a port start/stop the execution of the Ether Link constructed by means of clicking an item on the context menu which appears after they right-click the node. The execution of an Ether Link is based on the nodes in a network. If users make a port that a node has stop the execution of the Ether Link constructed, another node that the node has can still execute the Ether Link constructed.

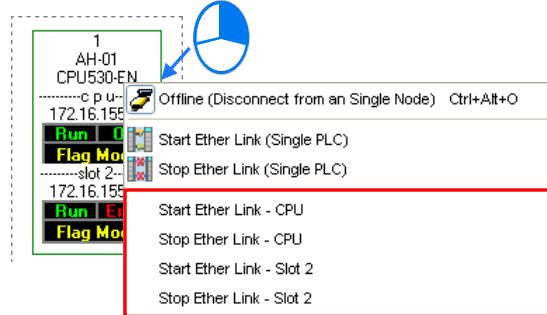

11.2.2.11 Monitoring Table and Error Log

After users double-click a data block, the **Data Monitor** window will appear. The users can view the values in the window. They can not change the values in the window.

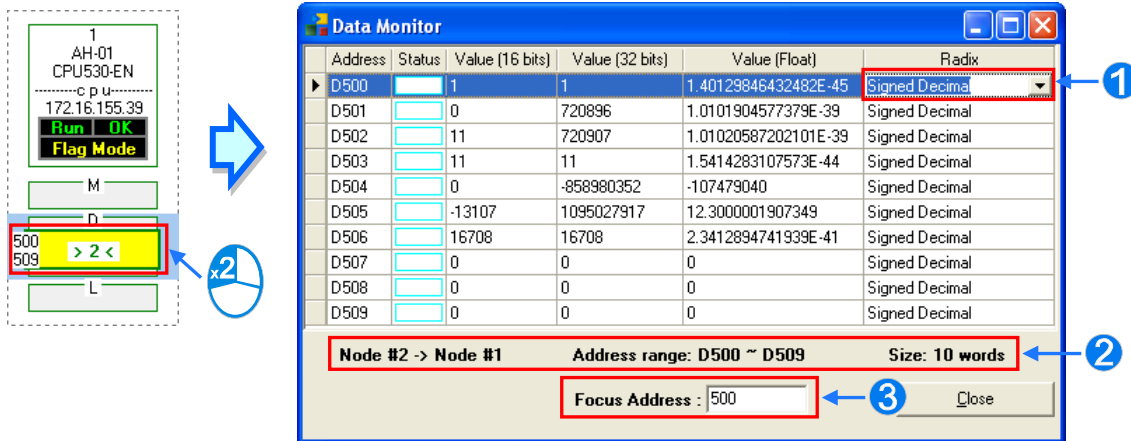

- ① After users click the **Radix** cell for a device, they can select a method of representing the value in the device on the drop-down list.
- ② The information about the data block which is monitored is displayed.
- ③ Users can type a device address in this box. After the users press **Enter** on the keyboard, they can easily view the device address in the window.

After a node is selected, the error log in the node will be displayed in the **Error Log** page. If the users select the **Ether Link Error Filter** checkbox, only the error log related to the Ether Link constructed will be listed. Besides, after the users click **Renew**, the error log in the node will be retrieved, and the error log retrieved will be displayed in the **Error Log** page. After the users click **Clear**, the error log in the **Error Log** page and the error log in the node will be cleared.

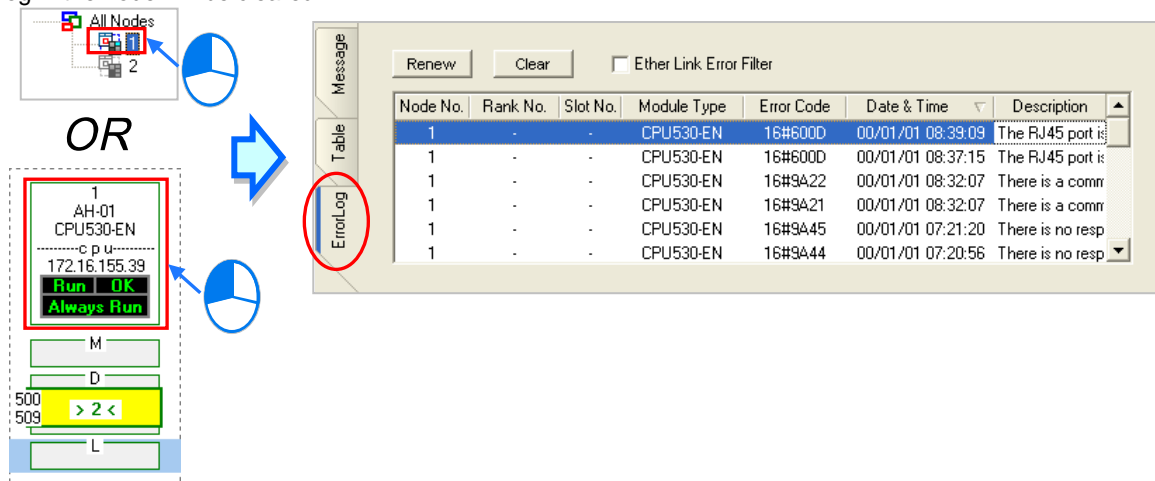

If the node selected consists of a CPU module and a module, the error log in the **Error Log** page will be composed of the errors occurring in the CPU module and the errors occurring in the module. If an error code in the **Error Log** page corresponds to an error occurring in the module, the model name of the module will be displayed in the **Module Type** cell for the error code, the rack on which the module is installed will be indicated by the number in the **Rack No.** cell for the error code, and the slot in which the module is installed will be indicated by the number in the **Slot No.** cell for the error code. If an error code in the **Error Log** page corresponds to an error occurring in the CPU module, there will be no numbers in the **Rack No.** cell for the error code and the **Slot No.** cell for the error code.

11.2.3 Related Special Auxiliary Relays and Special Data Registers

1. Descriptions of the related special auxiliary relays:

Device	Name	R/W	Description
SM1770	Executing an Ether Link (CPU)	R/W	OFF: The execution of an Ether Link stops. ON: An Ether Link is executed.
SM1772	Executing an Ether Link (Port 0)	R/W	OFF: The execution of an Ether Link stops. ON: An Ether Link is executed.
SM1773	Executing an Ether Link (Port 1)	R/W	OFF: The execution of an Ether Link stops. ON: An Ether Link is executed.
SM1774	Executing an Ether Link (Port 2)	R/W	OFF: The execution of an Ether Link stops. ON: An Ether Link is executed.
SM1775	Executing an Ether Link (Port 3)	R/W	OFF: The execution of an Ether Link stops. ON: An Ether Link is executed.
SM1776	Executing an Ether Link (Port 4)	R/W	OFF: The execution of an Ether Link stops. ON: An Ether Link is executed.
SM1777	Executing an Ether Link (Port 5)	R/W	OFF: The execution of an Ether Link stops. ON: An Ether Link is executed.
SM1778	Executing an Ether Link (Port 6)	R/W	OFF: The execution of an Ether Link stops. ON: An Ether Link is executed.
SM1779	Executing an Ether Link (Port 7)	R/W	OFF: The execution of an Ether Link stops. ON: An Ether Link is executed.
SM1780	Executing an Ether Link (Port 8)	R/W	OFF: The execution of an Ether Link stops. ON: An Ether Link is executed.
SM1781	Executing an Ether Link (Port 9)	R/W	OFF: The execution of an Ether Link stops. ON: An Ether Link is executed.



Device	Name	R/W	Description
SM1782	Executing an Ether Link (Port 10)	R/W	OFF: The execution of an Ether Link stops. ON: An Ether Link is executed.
SM1783	Executing an Ether Link (Port 11)	R/W	OFF: The execution of an Ether Link stops. ON: An Ether Link is executed.
SM1784	Executing an Ether Link (Port 12)	R/W	OFF: The execution of an Ether Link stops. ON: An Ether Link is executed.
SM1785	Executing an Ether Link (Port 13)	R/W	OFF: The execution of an Ether Link stops. ON: An Ether Link is executed.
SM1786	Executing an Ether Link (Port 14)	R/W	OFF: The execution of an Ether Link stops. ON: An Ether Link is executed.
SM1787	Executing an Ether Link (Port 15)	R/W	OFF: The execution of an Ether Link stops. ON: An Ether Link is executed.
SM1788	Ether Link error (CPU)	R	OFF: An Ether Link is executed incorrectly. ON: An Ether Link is executed correctly.
SM1790	Ether Link error (Port 0)	R	OFF: An Ether Link is executed incorrectly. ON: An Ether Link is executed correctly.
SM1791	Ether Link error (Port 1)	R	OFF: An Ether Link is executed incorrectly. ON: An Ether Link is executed correctly.
SM1792	Ether Link error (Port 2)	R	OFF: An Ether Link is executed incorrectly. ON: An Ether Link is executed correctly.
SM1793	Ether Link error (Port 3)	R	OFF: An Ether Link is executed incorrectly. ON: An Ether Link is executed correctly.
SM1794	Ether Link error (Port 4)	R	OFF: An Ether Link is executed incorrectly. ON: An Ether Link is executed correctly.
SM1795	Ether Link error (Port 5)	R	OFF: An Ether Link is executed incorrectly. ON: An Ether Link is executed correctly.
SM1796	Ether Link error (Port 6)	R	OFF: An Ether Link is executed incorrectly. ON: An Ether Link is executed correctly.
SM1797	Ether Link error (Port 7)	R	OFF: An Ether Link is executed incorrectly. ON: An Ether Link is executed correctly.
SM1798	Ether Link error (Port 8)	R	OFF: An Ether Link is executed incorrectly. ON: An Ether Link is executed correctly.
SM1799	Ether Link error (Port 9)	R	OFF: An Ether Link is executed incorrectly. ON: An Ether Link is executed correctly.
SM1800	Ether Link error (Port 10)	R	OFF: An Ether Link is executed incorrectly. ON: An Ether Link is executed correctly.
SM1801	Ether Link error (Port 11)	R	OFF: An Ether Link is executed incorrectly. ON: An Ether Link is executed correctly.
SM1802	Ether Link error (Port 12)	R	OFF: An Ether Link is executed incorrectly. ON: An Ether Link is executed correctly.
SM1803	Ether Link error (Port 13)	R	OFF: An Ether Link is executed incorrectly. ON: An Ether Link is executed correctly.
SM1804	Ether Link error (Port 14)	R	OFF: An Ether Link is executed incorrectly. ON: An Ether Link is executed correctly.
SM1805	Ether Link error (Port 15)	R	OFF: An Ether Link is executed incorrectly. ON: An Ether Link is executed correctly.
SM1806	Status of an Ether Link (CPU)	R	OFF: The execution of an Ether Link stops. ON: An Ether Link is executed.
SM1808	Status of an Ether Link (Port 0)	R	OFF: The execution of an Ether Link stops. ON: An Ether Link is executed.
SM1809	Status of an Ether Link (Port 1)	R	OFF: The execution of an Ether Link stops. ON: An Ether Link is executed.
SM1810	Status of an Ether Link (Port 2)	R	OFF: The execution of an Ether Link stops. ON: An Ether Link is executed.

Device	Name	R/W	Description
SM1811	Status of an Ether Link (Port 3)	R	OFF: The execution of an Ether Link stops. ON: An Ether Link is executed.
SM1812	Status of an Ether Link (Port 4)	R	OFF: The execution of an Ether Link stops. ON: An Ether Link is executed.
SM1813	Status of an Ether Link (Port 5)	R	OFF: The execution of an Ether Link stops. ON: An Ether Link is executed.
SM1814	Status of an Ether Link (Port 6)	R	OFF: The execution of an Ether Link stops. ON: An Ether Link is executed.
SM1815	Status of an Ether Link (Port 7)	R	OFF: The execution of an Ether Link stops. ON: An Ether Link is executed.
SM1816	Status of an Ether Link (Port 8)	R	OFF: The execution of an Ether Link stops. ON: An Ether Link is executed.
SM1817	Status of an Ether Link (Port 9)	R	OFF: The execution of an Ether Link stops. ON: An Ether Link is executed.
SM1818	Status of an Ether Link (Port 10)	R	OFF: The execution of an Ether Link stops. ON: An Ether Link is executed.
SM1819	Status of an Ether Link (Port 11)	R	OFF: The execution of an Ether Link stops. ON: An Ether Link is executed.
SM1820	Status of an Ether Link (Port 12)	R	OFF: The execution of an Ether Link stops. ON: An Ether Link is executed.
SM1821	Status of an Ether Link (Port 13)	R	OFF: The execution of an Ether Link stops. ON: An Ether Link is executed.
SM1822	Status of an Ether Link (Port 14)	R	OFF: The execution of an Ether Link stops. ON: An Ether Link is executed.
SM1823	Status of an Ether Link (Port 15)	R	OFF: The execution of an Ether Link stops. ON: An Ether Link is executed.
SM1824~ SM1951	Status of storage block 1~Status of storage block 128	R/W	OFF: A storage block is inactive in performing data exchange. ON: A storage block is active in performing data exchange.

2. Descriptions of the related special data registers:

Device	Name	R/W	Description
SR1792	High word of the IP address to which storage block 1 is connected	R	High word of the IP address to which storage block 1 is connected Example: If the remote IP address is 192.168.1.100, the value in SR1792 will be 0xC0A8.
SR1793	Low word of the IP address to which storage block 1 is connected	R	Low word of the IP address to which storage block 1 is connected Example: If the remote IP address is 192.168.1.100, the value in SR1793 is 0x0164.
⋮			
SR2046	High word of the IP address to which storage block 128 is connected	R	High word of the IP address to which storage block 128 is connected Example: If the remote IP address is 192.168.1.100, the value in SR2046 will be 0xC0A8.
SR2047	Low word of the IP address to which storage block 128 is connected	R	Low word of the IP address to which storage block 128 is connected Example: If the remote IP address is 192.168.1.100, the value in SR2047 will be 0x0164.

11.3 Data Exchange Function

AH500 series can exchange data with another Ethernet PLC not only by means of instructions, but also by a table interface.

An Ethernet PLC can exchange data with another Ethernet PLC not only by means of instructions, but also by a table interface. The data exchange tables which can be used by Ethernet PLCs are not completely the same. Please refer to the table below for more information about the quantity of data which a PLC can read/write, and the devices which can be involved in data exchange. A chart showing data exchange is provided below. Specification table:



11.3.1 MODBUS Data Exchange

11.3.1.1 MODBUS Data Exchange

Data exchange between electronic devices can be achieved via MODBUS protocol. Through MODBUS protocol, users can exchange data among Delta devices and any 3rd party devices, as long as they comply with the MODBUS standard. A chart showing information concerning MODBUS data exchange is provided below.

Communication mode	MODBUS		
Maximum number of connections	32		
Communication protocol	Standard Modbus and AH500 communication protocol		
Maximum quantity of data which can be read/written	Remote terminal unit	AH500 series CPU module	400 words 6400 bits
		DVP series PLCs	100 words 100 bits
		Others	100 words 100 bits
Supported devices	Remote terminal unit	AH500 series CPU module	X, Y, M, SM, SR, D, T, C, S, E
		DVP series PLCs	X, Y, M, D
		Others	Logical address 0x0000~0xFFFF
Supported models	AH500 advanced CPU modules (AHCPU511/521/531)		

11.3.1.2 MODBUS Data Exchange - PLC Parameter Setting

Double-click **HWCONFIG**, and then double-click **CPU**. After **CPU** is double-clicked, the **PLC Parameter Setting** window will be opened.

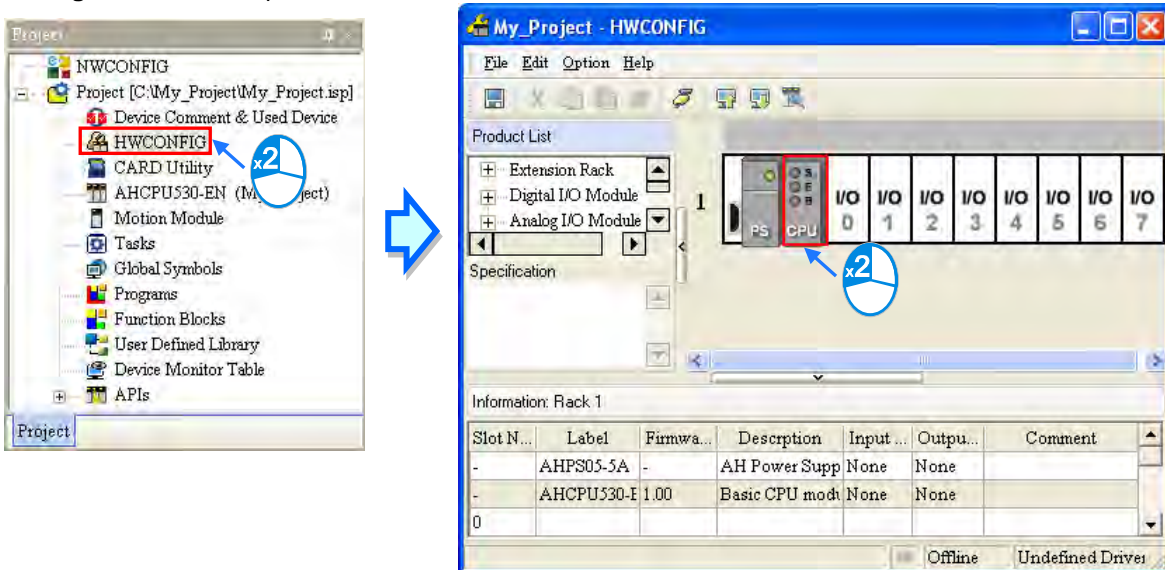

Click the **Data Exchange Setup - COM** tab.

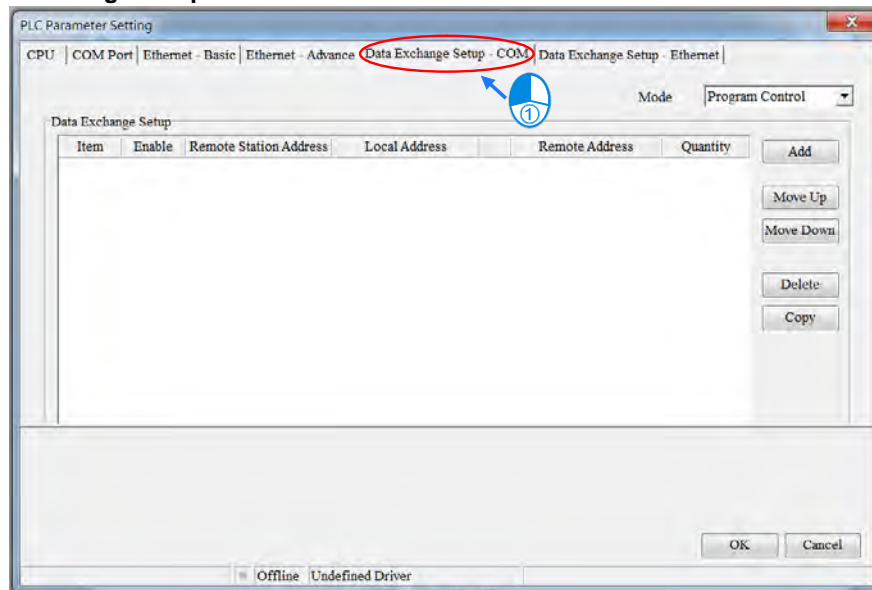

11

Owing to the fact that no data is set, there is a blank table in the **Data Exchange Setup** section. After **Add** is clicked, an item will be inserted. After the item is double-clicked, the **Item 1** window will appear.

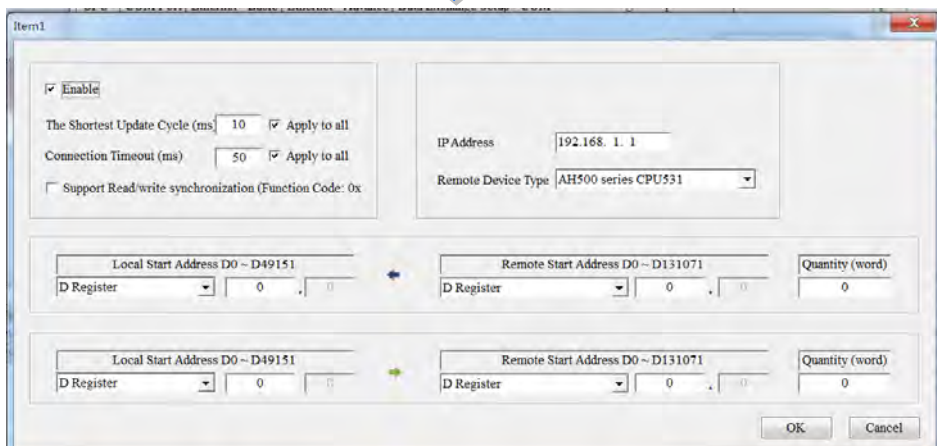
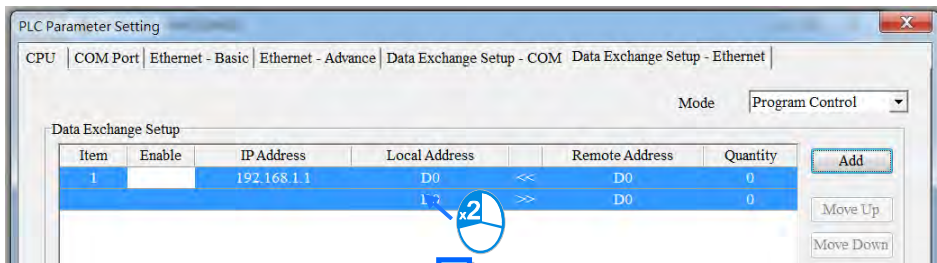
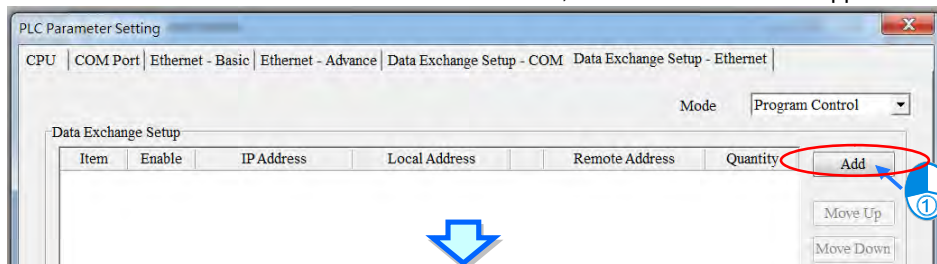



The **Item 1** window is described below.

- **Enable**
If users want to make the PLC execute the data exchange, they have to select the **Enable** checkbox. If the users want to stop the data exchange temporarily, they can leave the **Enable** checkbox unselected.
- **Slave Address**
Users have to set the station address of the slave with which the PLC will exchange data. If the users can not set the station address of the slave to which the PLC will connect, they can type 0 in the **Slave Address** box.
- **IP Address**
Users have to type the IP address of the slave to which the PLC will connect in the **IP Address** box.
- **The Shortest Update Cycle (ms)**
Users have to set the shortest cycle of updating the data exchange. A millisecond is a unit of time. When the data exchange is executed, it is updated at specific intervals. However, if the data exchange is prolonged due to network congestion or other reasons, it will be updated according to the actual situation.
- **Connection Timeout (ms)**
Users can set the longest time that is allowed to elapse before the data exchange is executed. A millisecond is a unit of time. If the data exchange is not executed after the longest time set elapses, a connection timeout will occur. The PLC still tries to connect to the slave station selected at specific intervals. Once the PLC connects to the slave station selected, the data exchange will be executed.
- **Support read/write synchronization (Function code 0x17)**
If the slave to which the PLC will connect can complete reading and writing simultaneously (Modbus function code 0x17), users can select the **Support read/write synchronization (Function code 0x17)** checkbox. After the **Support read/write synchronization (Function code 0x17)** checkbox is selected, the PLC will read data and write data simultaneously, and the efficiency in exchanging data will increase.
- **Device Type**
Users can select the model of the slave to which the PLC will connect in the **Device Type** drop-down list box. They can select a standard Modbus TCP device or a Delta PLC. If they select a Delta PLC, they can use the registers in the Delta PLC when they set data blocks.
- **Input**
Users can set the register in which the data read will be stored in the **Local Start Address** box. The register set can only be a D device. The users can set the register whose contents will be read in the **Remote Start Address** box. The register and the address which can be set depend on the device type selected in the **Device Type** drop-down list box. The users can set the quantity of data which will be read in the **Quantity** box. The unit used depends on the register type selected. 100 words (1600 bits) at most can be read. However, if the slave to which the PLC will connect is an AH500 series CPU module, 400 words (6400 bits) at most can be read.
- **Output**
Users can set the register whose contents will be written in the **Local Start Address** box. The register set can only be a D device. The users can set the register into which data will be written in the **Remote Start Address** box. The register and the address which can be set depend on the device type selected in the **Device Type** drop-down list box. The users can set the quantity of data which will be written in the **Quantity** box. The unit used depends on the register type selected. 100 words (1600 bits) at most can be written. However, if the slave to which the PLC will connect is an AH500 series CPU module, 400 words (6400 bits) at most can be written.

When users set a data exchange block, the local register set can only be a word device, and the remote register set can be a bit device. If the remote register set is a bit device, the device number of the remote register does not need to end with 0. For example, the remote register set can be D0.3. If the data which will be read or written is not composed of words, the local PLC will exchange bits with the remote PLC selected, and the bits which are not involved in the data exchange will remain unchanged. For example, if D0~D1 in the local PLC read M0~M19 in the remote PLC selected, the data read will be stored in D0.0~D1.3, and D1.4~D1.5 will remain unchanged.

After the users set a data exchange block, they have to click **OK**. The users can use this method to create several data exchange blocks.

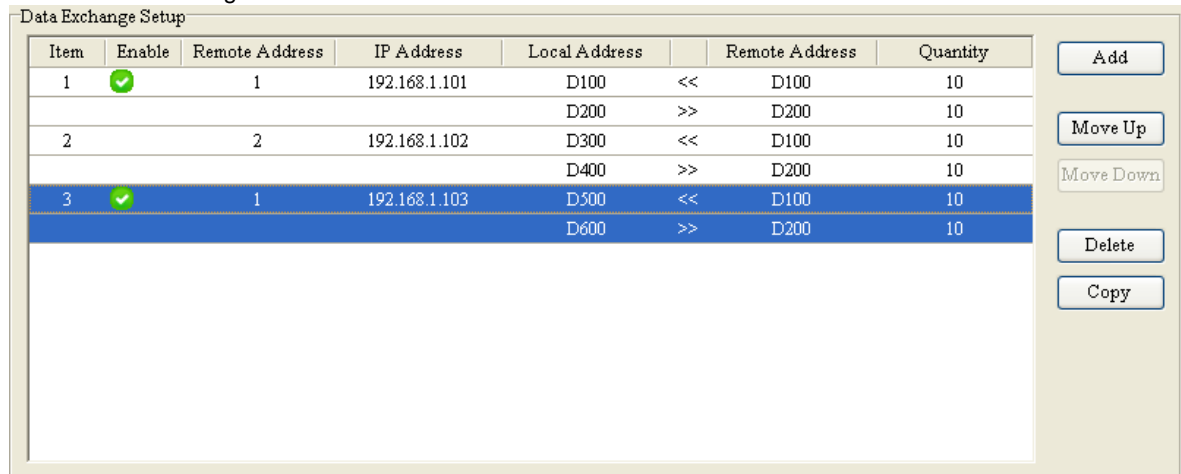

11

The users can manage the items in the table by means of the buttons at the right side of the table. The buttons are described below.

Button	Description
Move Up	Moving the item selected in the table upwards
Move Down	Moving the item selected in the table downwards
Delete	Deleting the item selected in the table
Copy	Copying the item selected in the table, and automatically adding the item which is copied to the bottom of the table

After the users create a data exchange table, they can select a mode in the **Mode** drop-down list box.

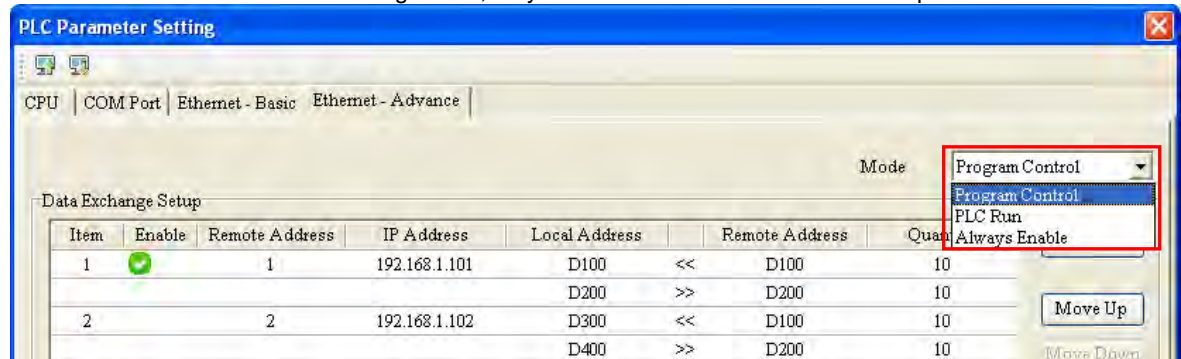

Mode	Description
Program Control	The execution of the data exchange is enabled or disabled by means of setting flags*2. If the flags are set to ON, the execution of the data exchange will be enabled.
PLC Run	When the PLC runs, the data exchange is executed.
Always Enable	The data exchange is executed whether the PLC runs or stops.

*1. The mode selected will be executed only if the Enable checkbox in the window used to set an item is selected.

*2. Please refer to section 11.3.3 for more information about setting flags.

11.3.1.3 MODBUS Data Exchange - Downloading/Uploading Parameters

After users set data exchange blocks, they have to download the parameters which are set to the PLC used. This section briefly introduces the downloading/uploading of the parameters set. Please refer to chapter 3 in ISPSOFT User Manual for more information. Before the users download the parameters which are set, they have to make sure that ISPSOFT connects to the PLC used normally. Please refer to section 2.4 in ISPSOFT User Manual for more information.

After the users click  in the upper left corner of the **PLC Parameter Setting** window, parameters set will

be downloaded. After the users click  in the upper left corner of the **PLC Parameter Setting** window, parameters in the PLC used will be uploaded.



After the users select the **Data Exchange-COM** checkbox, and click **OK** in the **Transfer Setup** window, the parameters related to the **Data Exchange-COM** checkbox will be downloaded or uploaded, including the parameters related to the data exchange set in the previous section.

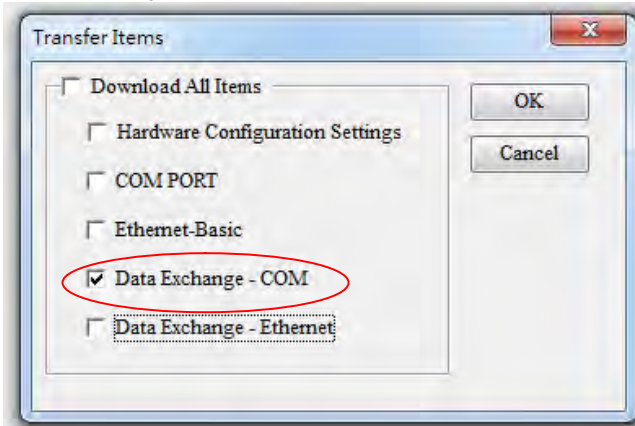

11.3.1.4 MODBUS Data Exchange – Special Auxiliary Relays

Device	Name	R/W	Description
SM1424	COM1 is exchanging data with slave 1 by Modbus.	R	ON: when the Modbus connection is enabled and the master accesses data from slave 1.
SM1425	COM1 is exchanging data with slave 2 by Modbus.	R	ON: when the Modbus connection is enabled and the master accesses data from slave 2.
SM1426	COM1 is exchanging data with slave 3 by Modbus.	R	ON: when the Modbus connection is enabled and the master accesses data from slave 3.
SM1427	COM1 is exchanging data with slave 4 by Modbus.	R	ON: when the Modbus connection is enabled and the master accesses data from slave 4.
SM1428	COM1 is exchanging data with slave 5 by Modbus.	R	ON: when the Modbus connection is enabled and the master accesses data from slave 5.
SM1429	COM1 is exchanging data with slave 6 by Modbus.	R	ON: when the Modbus connection is enabled and the master accesses data from slave 6.
SM1430	COM1 is exchanging data with slave 7 by Modbus.	R	ON: when the Modbus connection is enabled and the master accesses data from slave 7.
SM1431	COM1 is exchanging data with slave 8 by Modbus.	R	ON: when the Modbus connection is enabled and the

Device	Name	R/W	Description
			master accesses data from slave 8.
SM1432	COM1 is exchanging data with slave 9 by Modbus.	R	ON: when the Modbus connection is enabled and the master accesses data from slave 9.
SM1433	COM1 is exchanging data with slave 10 by Modbus.	R	ON: when the Modbus connection is enabled and the master accesses data from slave 10.
SM1434	COM1 is exchanging data with slave 11 by Modbus.	R	ON: when the Modbus connection is enabled and the master accesses data from slave 11.
SM1435	COM1 is exchanging data with slave 12 by Modbus.	R	ON: when the Modbus connection is enabled and the master accesses data from slave 12.
SM1436	COM1 is exchanging data with slave 13 by Modbus.	R	ON: when the Modbus connection is enabled and the master accesses data from slave 13.
SM1437	COM1 is exchanging data with slave 14 by Modbus.	R	ON: when the Modbus connection is enabled and the master accesses data from slave 14.
SM1438	COM1 is exchanging data with slave 15 by Modbus.	R	ON: when the Modbus connection is enabled and the master accesses data from slave 15.
SM1439	COM1 is exchanging data with slave 16 by Modbus.	R	ON: when the Modbus connection is enabled and the master accesses data from slave 16.
SM1440	COM1 is exchanging data with slave 17 by Modbus.	R	ON: when the Modbus connection is enabled and the master accesses data from slave 17.
SM1441	COM1 is exchanging data with slave 18 by Modbus.	R	ON: when the Modbus connection is enabled and the master accesses data from slave 18.
SM1442	COM1 is exchanging data with slave 19 by Modbus.	R	ON: when the Modbus connection is enabled and the master accesses data from slave 19.
SM1443	COM1 is exchanging data with slave 20 by Modbus.	R	ON: when the Modbus connection is enabled and the master accesses data from slave 20.
SM1444	COM1 is exchanging data with slave 21 by Modbus.	R	ON: when the Modbus connection is enabled and the master accesses data from slave 21.
SM1445	COM1 is exchanging data with slave 22 by	R	ON: when the Modbus

11

Device	Name	R/W	Description
	Modbus.		connection is enabled and the master accesses data from slave 22.
SM1446	COM1 is exchanging data with slave 23 by Modbus.	R	ON: when the Modbus connection is enabled and the master accesses data from slave 23.
SM1447	COM1 is exchanging data with slave 24 by Modbus.	R	ON: when the Modbus connection is enabled and the master accesses data from slave 24.
SM1448	COM1 is exchanging data with slave 25 by Modbus.	R	ON: when the Modbus connection is enabled and the master accesses data from slave 25.
SM1449	COM1 is exchanging data with slave 26 by Modbus.	R	ON: when the Modbus connection is enabled and the master accesses data from slave 26.
SM1450	COM1 is exchanging data with slave 27 by Modbus.	R	ON: when the Modbus connection is enabled and the master accesses data from slave 27.
SM1451	COM1 is exchanging data with slave 28 by Modbus.	R	ON: when the Modbus connection is enabled and the master accesses data from slave 28.
SM1452	COM1 is exchanging data with slave 29 by Modbus.	R	ON: when the Modbus connection is enabled and the master accesses data from slave 29.
SM1453	COM1 is exchanging data with slave 30 by Modbus.	R	ON: when the Modbus connection is enabled and the master accesses data from slave 30.
SM1454	COM1 is exchanging data with slave 31 by Modbus.	R	ON: when the Modbus connection is enabled and the master accesses data from slave 31.
SM1455	COM1 is exchanging data with slave 32 by Modbus.	R	ON: when the Modbus connection is enabled and the master accesses data from slave 32.
SM1456	An error occurs when COM1 reads data from slave 1 by Modbus.	R	ON: when the Modbus connection is enabled and an error occurs in the reading of data from slave 1.
SM1457	An error occurs when COM1 reads data from slave 2 by Modbus.	R	ON: when the Modbus connection is enabled and an error occurs in the reading of data from slave 2.
SM1458	An error occurs when COM1 reads data from slave 3 by Modbus.	R	ON: when the Modbus connection is enabled and an error occurs in the reading of data from slave 3.

Device	Name	R/W	Description
SM1459	An error occurs when COM1 reads data from slave 4 by Modbus.	R	ON: when the Modbus connection is enabled and an error occurs in the reading of data from slave 4.
SM1460	An error occurs when COM1 reads data from slave 5 by Modbus.	R	ON: when the Modbus connection is enabled and an error occurs in the reading of data from slave 5.
SM1461	An error occurs when COM1 reads data from slave 6 by Modbus.	R	ON: when the Modbus connection is enabled and an error occurs in the reading of data from slave 6.
SM1462	An error occurs when COM1 reads data from slave 7 by Modbus.	R	ON: when the Modbus connection is enabled and an error occurs in the reading of data from slave 7.
SM1463	An error occurs when COM1 reads data from slave 8 by Modbus.	R	ON: when the Modbus connection is enabled and an error occurs in the reading of data from slave 8.
SM1464	An error occurs when COM1 reads data from slave 9 by Modbus.	R	ON: when the Modbus connection is enabled and an error occurs in the reading of data from slave 9.
SM1465	An error occurs when COM1 reads data from slave 10 by Modbus.	R	ON: when the Modbus connection is enabled and an error occurs in the reading of data from slave 10.
SM1466	An error occurs when COM1 reads data from slave 11 by Modbus.	R	ON: when the Modbus connection is enabled and an error occurs in the reading of data from slave 11.
SM1467	An error occurs when COM1 reads data from slave 12 by Modbus.	R	ON: when the Modbus connection is enabled and an error occurs in the reading of data from slave 12.
SM1468	An error occurs when COM1 reads data from slave 13 by Modbus.	R	ON: when the Modbus connection is enabled and an error occurs in the reading of data from slave 13.
SM1469	An error occurs when COM1 reads data from slave 14 by Modbus.	R	ON: when the Modbus connection is enabled and an error occurs in the reading of data from slave 14.
SM1470	An error occurs when COM1 reads data from slave 15 by Modbus.	R	ON: when the Modbus connection is enabled and an error occurs in the reading of data from slave 15.
SM1471	An error occurs when COM1 reads data from slave 16 by Modbus.	R	ON: when the Modbus connection is enabled and an error occurs in the reading of data from slave 16.
SM1472	An error occurs when COM1 reads data from slave 17 by Modbus.	R	ON: when the Modbus connection is enabled and an error occurs in the reading of



Device	Name	R/W	Description
			data from slave 17.
SM1473	An error occurs when COM1 reads data from slave 18 by Modbus.	R	ON: when the Modbus connection is enabled and an error occurs in the reading of data from slave 18.
SM1474	An error occurs when COM1 reads data from slave 19 by Modbus.	R	ON: when the Modbus connection is enabled and an error occurs in the reading of data from slave 19.
SM1475	An error occurs when COM1 reads data from slave 20 by Modbus.	R	ON: when the Modbus connection is enabled and an error occurs in the reading of data from slave 20.
SM1476	An error occurs when COM1 reads data from slave 21 by Modbus.	R	ON: when the Modbus connection is enabled and an error occurs in the reading of data from slave 21.
SM1477	An error occurs when COM1 reads data from slave 22 by Modbus.	R	ON: when the Modbus connection is enabled and an error occurs in the reading of data from slave 22.
SM1478	An error occurs when COM1 reads data from slave 23 by Modbus.	R	ON: when the Modbus connection is enabled and an error occurs in the reading of data from slave 23.
SM1479	An error occurs when COM1 reads data from slave 24 by Modbus.	R	ON: when the Modbus connection is enabled and an error occurs in the reading of data from slave 24.
SM1480	An error occurs when COM1 reads data from slave 25 by Modbus.	R	ON: when the Modbus connection is enabled and an error occurs in the reading of data from slave 25.
SM1481	An error occurs when COM1 reads data from slave 26 by Modbus.	R	ON: when the Modbus connection is enabled and an error occurs in the reading of data from slave 26.
SM1482	An error occurs when COM1 reads data from slave 27 by Modbus.	R	ON: when the Modbus connection is enabled and an error occurs in the reading of data from slave 27.
SM1483	An error occurs when COM1 reads data from slave 28 by Modbus.	R	ON: when the Modbus connection is enabled and an error occurs in the reading of data from slave 28.
SM1484	An error occurs when COM1 reads data from slave 29 by Modbus.	R	ON: when the Modbus connection is enabled and an error occurs in the reading of data from slave 29.
SM1485	An error occurs when COM1 reads data from slave 30 by Modbus.	R	ON: when the Modbus connection is enabled and an error occurs in the reading of data from slave 30.
SM1486	An error occurs when COM1 reads data from slave 31 by Modbus.	R	ON: when the Modbus connection is enabled and an

Device	Name	R/W	Description
			error occurs in the reading of data from slave 31.
SM1487	An error occurs when COM1 reads data from slave 32 by Modbus.	R	ON: when the Modbus connection is enabled and an error occurs in the reading of data from slave 32.
SM1488	An error occurs when COM1 writes data to slave 1 by Modbus.	R	ON: when the Modbus connection is enabled and an error occurs in the writing of data to slave 1.
SM1489	An error occurs when COM1 writes data to slave 2 by Modbus.	R	ON: when the Modbus connection is enabled and an error occurs in the writing of data to slave 2.
SM1490	An error occurs when COM1 writes data to slave 3 by Modbus.	R	ON: when the Modbus connection is enabled and an error occurs in the writing of data to slave 3.
SM1491	An error occurs when COM1 writes data to slave 4 by Modbus.	R	ON: when the Modbus connection is enabled and an error occurs in the writing of data to slave 4.
SM1492	An error occurs when COM1 writes data to slave 5 by Modbus.	R	ON: when the Modbus connection is enabled and an error occurs in the writing of data to slave 5.
SM1493	An error occurs when COM1 writes data to slave 6 by Modbus.	R	ON: when the Modbus connection is enabled and an error occurs in the writing of data to slave 6.
SM1494	An error occurs when COM1 writes data to slave 7 by Modbus.	R	ON: when the Modbus connection is enabled and an error occurs in the writing of data to slave 7.
SM1495	An error occurs when COM1 writes data to slave 8 by Modbus.	R	ON: when the Modbus connection is enabled and an error occurs in the writing of data to slave 8.
SM1496	An error occurs when COM1 writes data to slave 9 by Modbus.	R	ON: when the Modbus connection is enabled and an error occurs in the writing of data to slave 9.
SM1497	An error occurs when COM1 writes data to slave 10 by Modbus.	R	ON: when the Modbus connection is enabled and an error occurs in the writing of data to slave 10.
SM1498	An error occurs when COM1 writes data to slave 11 by Modbus.	R	ON: when the Modbus connection is enabled and an error occurs in the writing of data to slave 11.
SM1499	An error occurs when COM1 writes data to slave 12 by Modbus.	R	ON: when the Modbus connection is enabled and an error occurs in the writing of data to slave 12.
SM1500	An error occurs when COM1 writes data to	R	ON: when the Modbus



Device	Name	R/W	Description
	slave 13 by Modbus.		connection is enabled and an error occurs in the writing of data to slave 13.
SM1501	An error occurs when COM1 writes data to slave 14 by Modbus.	R	ON: when the Modbus connection is enabled and an error occurs in the writing of data to slave 14.
SM1502	An error occurs when COM1 writes data to slave 15 by Modbus.	R	ON: when the Modbus connection is enabled and an error occurs in the writing of data to slave 15.
SM1503	An error occurs when COM1 writes data to slave 16 by Modbus.	R	ON: when the Modbus connection is enabled and an error occurs in the writing of data to slave 16.
SM1504	An error occurs when COM1 writes data to slave 17 by Modbus.	R	ON: when the Modbus connection is enabled and an error occurs in the writing of data to slave 17.
SM1505	An error occurs when COM1 writes data to slave 18 by Modbus.	R	ON: when the Modbus connection is enabled and an error occurs in the writing of data to slave 18.
SM1506	An error occurs when COM1 writes data to slave 19 by Modbus.	R	ON: when the Modbus connection is enabled and an error occurs in the writing of data to slave 19.
SM1507	An error occurs when COM1 writes data to slave 20 by Modbus.	R	ON: when the Modbus connection is enabled and an error occurs in the writing of data to slave 20.
SM1508	An error occurs when COM1 writes data to slave 21 by Modbus.	R	ON: when the Modbus connection is enabled and an error occurs in the writing of data to slave 21.
SM1509	An error occurs when COM1 writes data to slave 22 by Modbus.	R	ON: when the Modbus connection is enabled and an error occurs in the writing of data to slave 22.
SM1510	An error occurs when COM1 writes data to slave 23 by Modbus.	R	ON: when the Modbus connection is enabled and an error occurs in the writing of data to slave 23.
SM1511	An error occurs when COM1 writes data to slave 24 by Modbus.	R	ON: when the Modbus connection is enabled and an error occurs in the writing of data to slave 24.
SM1512	An error occurs when COM1 writes data to slave 25 by Modbus.	R	ON: when the Modbus connection is enabled and an error occurs in the writing of data to slave 25.
SM1513	An error occurs when COM1 writes data to slave 26 by Modbus.	R	ON: when the Modbus connection is enabled and an error occurs in the writing of data to slave 26.

Device	Name	R/W	Description
SM1514	An error occurs when COM1 writes data to slave 27 by Modbus.	R	ON: when the Modbus connection is enabled and an error occurs in the writing of data to slave 27.
SM1515	An error occurs when COM1 writes data to slave 28 by Modbus.	R	ON: when the Modbus connection is enabled and an error occurs in the writing of data to slave 28.
SM1516	An error occurs when COM1 writes data to slave 29 by Modbus.	R	ON: when the Modbus connection is enabled and an error occurs in the writing of data to slave 29.
SM1517	An error occurs when COM1 writes data to slave 30 by Modbus.	R	ON: when the Modbus connection is enabled and an error occurs in the writing of data to slave 30.
SM1518	An error occurs when COM1 writes data to slave 31 by Modbus.	R	ON: when the Modbus connection is enabled and an error occurs in the writing of data to slave 31.
SM1519	An error occurs when COM1 writes data to slave 32 by Modbus.	R	ON: when the Modbus connection is enabled and an error occurs in the writing of data to slave 32.
SM1520	COM1 finishes reading data from slave 1 by Modbus.	R	ON: when a Modbus connection is enabled for COM1 and the master finishes reading data from slave 1.
SM1521	COM1 finishes reading data from slave 2 by Modbus.	R	ON: when a Modbus connection is enabled for COM1 and the master finishes reading data from slave 2.
SM1522	COM1 finishes reading data from slave 3 by Modbus.	R	ON: when a Modbus connection is enabled for COM1 and the master finishes reading data from slave 3.
SM1523	COM1 finishes reading data from slave 4 by Modbus.	R	ON: when a Modbus connection is enabled for COM1 and the master finishes reading data from slave 4.
SM1524	COM1 finishes reading data from slave 5 by Modbus.	R	ON: when a Modbus connection is enabled for COM1 and the master finishes reading data from slave 5.
SM1525	COM1 finishes reading data from slave 6 by Modbus.	R	ON: when a Modbus connection is enabled for COM1 and the master finishes reading data from slave 6.
SM1526	COM1 finishes reading data from slave 7 by Modbus.	R	ON: when a Modbus connection is enabled for COM1 and the master finishes reading data from slave 7.
SM1527	COM1 finishes reading data from slave 8 by Modbus.	R	ON: when a Modbus connection is enabled for COM1 and the master finishes



Device	Name	R/W	Description
			reading data from slave 8.
SM1528	COM1 finishes reading data from slave 9 by Modbus.	R	ON: when a Modbus connection is enabled for COM1 and the master finishes reading data from slave 9.
SM1529	COM1 finishes reading data from slave 10 by Modbus.	R	ON: when a Modbus connection is enabled for COM1 and the master finishes reading data from slave 10.
SM1530	COM1 finishes reading data from slave 11 by Modbus.	R	ON: when a Modbus connection is enabled for COM1 and the master finishes reading data from slave 11.
SM1531	COM1 finishes reading data from slave 12 by Modbus.	R	ON: when a Modbus connection is enabled for COM1 and the master finishes reading data from slave 12.
SM1532	COM1 finishes reading data from slave 13 by Modbus.	R	ON: when a Modbus connection is enabled for COM1 and the master finishes reading data from slave 13.
SM1533	COM1 finishes reading data from slave 14 by Modbus.	R	ON: when a Modbus connection is enabled for COM1 and the master finishes reading data from slave 14.
SM1534	COM1 finishes reading data from slave 15 by Modbus.	R	ON: when a Modbus connection is enabled for COM1 and the master finishes reading data from slave 15.
SM1535	COM1 finishes reading data from slave 16 by Modbus.	R	ON: when a Modbus connection is enabled for COM1 and the master finishes reading data from slave 16.
SM1536	COM1 finishes reading data from slave 17 by Modbus.	R	ON: when a Modbus connection is enabled for COM1 and the master finishes reading data from slave 17.
SM1537	COM1 finishes reading data from slave 18 by Modbus.	R	ON: when a Modbus connection is enabled for COM1 and the master finishes reading data from slave 18.
SM1538	COM1 finishes reading data from slave 19 by Modbus.	R	ON: when a Modbus connection is enabled for COM1 and the master finishes reading data from slave 19.
SM1539	COM1 finishes reading data from slave 20 by Modbus.	R	ON: when a Modbus connection is enabled for COM1 and the master finishes reading data from slave 20.
SM1540	COM1 finishes reading data from slave 21 by Modbus.	R	ON: when a Modbus connection is enabled for COM1 and the master finishes reading data from slave 21.
SM1541	COM1 finishes reading data from slave 22 by Modbus.	R	ON: when a Modbus connection is enabled for

Device	Name	R/W	Description
			COM1 and the master finishes reading data from slave 22.
SM1542	COM1 finishes reading data from slave 23 by Modbus.	R	ON: when a Modbus connection is enabled for COM1 and the master finishes reading data from slave 23.
SM1543	COM1 finishes reading data from slave 24 by Modbus.	R	ON: when a Modbus connection is enabled for COM1 and the master finishes reading data from slave 24.
SM1544	COM1 finishes reading data from slave 25 by Modbus.	R	ON: when a Modbus connection is enabled for COM1 and the master finishes reading data from slave 25.
SM1545	COM1 finishes reading data from slave 26 by Modbus.	R	ON: when a Modbus connection is enabled for COM1 and the master finishes reading data from slave 26.
SM1546	COM1 finishes reading data from slave 27 by Modbus.	R	ON: when a Modbus connection is enabled for COM1 and the master finishes reading data from slave 27.
SM1547	COM1 finishes reading data from slave 28 by Modbus.	R	ON: when a Modbus connection is enabled for COM1 and the master finishes reading data from slave 28.
SM1548	COM1 finishes reading data from slave 29 by Modbus.	R	ON: when a Modbus connection is enabled for COM1 and the master finishes reading data from slave 29.
SM1549	COM1 finishes reading data from slave 30 by Modbus.	R	ON: when a Modbus connection is enabled for COM1 and the master finishes reading data from slave 30.
SM1550	COM1 finishes reading data from slave 31 by Modbus.	R	ON: when a Modbus connection is enabled for COM1 and the master finishes reading data from slave 31.
SM1551	COM1 finishes reading data from slave 32 by Modbus.	R	ON: when a Modbus connection is enabled for COM1 and the master finishes reading data from slave 32.
SM1552	COM1 finishes writing data to slave 1 by Modbus.	R	ON: when a Modbus connection is enabled for COM1 and the master finishes writing data to slave 1.
SM1553	COM1 finishes writing data to slave 2 by Modbus.	R	ON: when a Modbus connection is enabled for COM1 and the master finishes writing data to slave 2.
SM1554	COM1 finishes writing data to slave 3 by Modbus.	R	ON: when a Modbus connection is enabled for COM1 and the master finishes writing data to slave 3.
SM1555	COM1 finishes writing data to slave 4 by	R	ON: when a Modbus

11

Device	Name	R/W	Description
	Modbus.		connection is enabled for COM1 and the master finishes writing data to slave 4.
SM1556	COM1 finishes writing data to slave 5 by Modbus.	R	ON: when a Modbus connection is enabled for COM1 and the master finishes writing data to slave 5.
SM1557	COM1 finishes writing data to slave 6 by Modbus.	R	ON: when a Modbus connection is enabled for COM1 and the master finishes writing data to slave 6.
SM1558	COM1 finishes writing data to slave 7 by Modbus.	R	ON: when a Modbus connection is enabled for COM1 and the master finishes writing data to slave 7.
SM1559	COM1 finishes writing data to slave 8 by Modbus.	R	ON: when a Modbus connection is enabled for COM1 and the master finishes writing data to slave 8.
SM1560	COM1 finishes writing data to slave 9 by Modbus.	R	ON: when a Modbus connection is enabled for COM1 and the master finishes writing data to slave 9.
SM1561	COM1 finishes writing data to slave 10 by Modbus.	R	ON: when a Modbus connection is enabled for COM1 and the master finishes writing data to slave 10.
SM1562	COM1 finishes writing data to slave 11 by Modbus.	R	ON: when a Modbus connection is enabled for COM1 and the master finishes writing data to slave 11.
SM1563	COM1 finishes writing data to slave 12 by Modbus.	R	ON: when a Modbus connection is enabled for COM1 and the master finishes writing data to slave 12.
SM1564	COM1 finishes writing data to slave 13 by Modbus.	R	ON: when a Modbus connection is enabled for COM1 and the master finishes writing data to slave 13.
SM1565	COM1 finishes writing data to slave 14 by Modbus.	R	ON: when a Modbus connection is enabled for COM1 and the master finishes writing data to slave 14.
SM1566	COM1 finishes writing data to slave 15 by Modbus.	R	ON: when a Modbus connection is enabled for COM1 and the master finishes writing data to slave 15.
SM1567	COM1 finishes writing data to slave 16 by Modbus.	R	ON: when a Modbus connection is enabled for COM1 and the master finishes writing data to slave 16.
SM1568	COM1 finishes writing data to slave 17 by Modbus.	R	ON: when a Modbus connection is enabled for COM1 and the master finishes writing data to slave 17.

Device	Name	R/W	Description
SM1569	COM1 finishes writing data to slave 18 by Modbus.	R	ON: when a Modbus connection is enabled for COM1 and the master finishes writing data to slave 18.
SM1570	COM1 finishes writing data to slave 19 by Modbus.	R	ON: when a Modbus connection is enabled for COM1 and the master finishes writing data to slave 19.
SM1571	COM1 finishes writing data to slave 20 by Modbus.	R	ON: when a Modbus connection is enabled for COM1 and the master finishes writing data to slave 20.
SM1572	COM1 finishes writing data to slave 21 by Modbus.	R	ON: when a Modbus connection is enabled for COM1 and the master finishes writing data to slave 21.
SM1573	COM1 finishes writing data to slave 22 by Modbus.	R	ON: when a Modbus connection is enabled for COM1 and the master finishes writing data to slave 22.
SM1574	COM1 finishes writing data to slave 23 by Modbus.	R	ON: when a Modbus connection is enabled for COM1 and the master finishes writing data to slave 23.
SM1575	COM1 finishes writing data to slave 24 by Modbus.	R	ON: when a Modbus connection is enabled for COM1 and the master finishes writing data to slave 24.
SM1576	COM1 finishes writing data to slave 25 by Modbus.	R	ON: when a Modbus connection is enabled for COM1 and the master finishes writing data to slave 25.
SM1577	COM1 finishes writing data to slave 26 by Modbus.	R	ON: when a Modbus connection is enabled for COM1 and the master finishes writing data to slave 26.
SM1578	COM1 finishes writing data to slave 27 by Modbus.	R	ON: when a Modbus connection is enabled for COM1 and the master finishes writing data to slave 27.
SM1579	COM1 finishes writing data to slave 28 by Modbus.	R	ON: when a Modbus connection is enabled for COM1 and the master finishes writing data to slave 28.
SM1580	COM1 finishes writing data to slave 29 by Modbus.	R	ON: when a Modbus connection is enabled for COM1 and the master finishes writing data to slave 29.
SM1581	COM1 finishes writing data to slave 30 by Modbus.	R	ON: when a Modbus connection is enabled for COM1 and the master finishes writing data to slave 30.
SM1582	COM1 finishes writing data to slave 31 by Modbus.	R	ON: when a Modbus connection is enabled for COM1 and the master finishes



Device	Name	R/W	Description
			writing data to slave 31.
SM1583	COM1 finishes writing data to slave 32 by Modbus.	R	ON: when a Modbus connection is enabled for COM1 and the master finishes writing data to slave 32.
SM1752	COM2 is exchanging data with slave 1 by Modbus.	R	ON: when the Modbus connection is enabled and the master accesses data from slave 1.
SM1753	COM2 is exchanging data with slave 2 by Modbus.	R	ON: when the Modbus connection is enabled and the master accesses data from slave 2.
SM1754	COM2 is exchanging data with slave 3 by Modbus.	R	ON: when the Modbus connection is enabled and the master accesses data from slave 3.
SM1755	COM2 is exchanging data with slave 4 by Modbus.	R	ON: when the Modbus connection is enabled and the master accesses data from slave 4.
SM1756	COM2 is exchanging data with slave 5 by Modbus.	R	ON: when the Modbus connection is enabled and the master accesses data from slave 5.
SM1757	COM2 is exchanging data with slave 6 by Modbus.	R	ON: when the Modbus connection is enabled and the master accesses data from slave 6.
SM1758	COM2 is exchanging data with slave 7 by Modbus.	R	ON: when the Modbus connection is enabled and the master accesses data from slave 7.
SM1759	COM2 is exchanging data with slave 8 by Modbus.	R	ON: when the Modbus connection is enabled and the master accesses data from slave 8.
SM1760	COM2 is exchanging data with slave 9 by Modbus.	R	ON: when the Modbus connection is enabled and the master accesses data from slave 9.
SM1761	COM2 is exchanging data with slave 10 by Modbus.	R	ON: when the Modbus connection is enabled and the master accesses data from slave 10.
SM1762	COM2 is exchanging data with slave 11 by Modbus.	R	ON: when the Modbus connection is enabled and the master accesses data from slave 11.
SM1763	COM2 is exchanging data with slave 12 by Modbus.	R	ON: when the Modbus connection is enabled and the master accesses data from slave 12.
SM1764	COM2 is exchanging data with slave 13 by Modbus.	R	ON: when the Modbus connection is enabled and the

Device	Name	R/W	Description
			master accesses data from slave 13.
SM1765	COM2 is exchanging data with slave 14 by Modbus.	R	ON: when the Modbus connection is enabled and the master accesses data from slave 14.
SM1766	COM2 is exchanging data with slave 15 by Modbus.	R	ON: when the Modbus connection is enabled and the master accesses data from slave 15.
SM1767	COM2 is exchanging data with slave 16 by Modbus.	R	ON: when the Modbus connection is enabled and the master accesses data from slave 16.
SM1768	COM2 is exchanging data with slave 17 by Modbus.	R	ON: when the Modbus connection is enabled and the master accesses data from slave 17.
SM1769	COM2 is exchanging data with slave 18 by Modbus.	R	ON: when the Modbus connection is enabled and the master accesses data from slave 18.
SM1770	COM2 is exchanging data with slave 19 by Modbus.	R	ON: when the Modbus connection is enabled and the master accesses data from slave 19.
SM1771	COM2 is exchanging data with slave 20 by Modbus.	R	ON: when the Modbus connection is enabled and the master accesses data from slave 20.
SM1772	COM2 is exchanging data with slave 21 by Modbus.	R	ON: when the Modbus connection is enabled and the master accesses data from slave 21.
SM1773	COM2 is exchanging data with slave 22 by Modbus.	R	ON: when the Modbus connection is enabled and the master accesses data from slave 22.
SM1774	COM2 is exchanging data with slave 23 by Modbus.	R	ON: when the Modbus connection is enabled and the master accesses data from slave 23.
SM1775	COM2 is exchanging data with slave 24 by Modbus.	R	ON: when the Modbus connection is enabled and the master accesses data from slave 24.
SM1776	COM2 is exchanging data with slave 25 by Modbus.	R	ON: when the Modbus connection is enabled and the master accesses data from slave 25.
SM1777	COM2 is exchanging data with slave 26 by Modbus.	R	ON: when the Modbus connection is enabled and the master accesses data from slave 26.
SM1778	COM2 is exchanging data with slave 27 by	R	ON: when the Modbus

11

Device	Name	R/W	Description
	Modbus.		connection is enabled and the master accesses data from slave 27.
SM1779	COM2 is exchanging data with slave 28 by Modbus.	R	ON: when the Modbus connection is enabled and the master accesses data from slave 28.
SM1780	COM2 is exchanging data with slave 29 by Modbus.	R	ON: when the Modbus connection is enabled and the master accesses data from slave 29.
SM1781	COM2 is exchanging data with slave 30 by Modbus.	R	ON: when the Modbus connection is enabled and the master accesses data from slave 30.
SM1782	COM2 is exchanging data with slave 31 by Modbus.	R	ON: when the Modbus connection is enabled and the master accesses data from slave 31.
SM1783	COM2 is exchanging data with slave 32 by Modbus.	R	ON: when the Modbus connection is enabled and the master accesses data from slave 32.
SM1784	An error occurs when COM2 reads data from slave 1 by Modbus.	R	ON: when the Modbus connection is enabled and an error occurs in the reading of data from slave 1.
SM1785	An error occurs when COM2 reads data from slave 2 by Modbus.	R	ON: when the Modbus connection is enabled and an error occurs in the reading of data from slave 2.
SM1786	An error occurs when COM2 reads data from slave 3 by Modbus.	R	ON: when the Modbus connection is enabled and an error occurs in the reading of data from slave 3.
SM1787	An error occurs when COM2 reads data from slave 4 by Modbus.	R	ON: when the Modbus connection is enabled and an error occurs in the reading of data from slave 4.
SM1788	An error occurs when COM2 reads data from slave 5 by Modbus.	R	ON: when the Modbus connection is enabled and an error occurs in the reading of data from slave 5.
SM1789	An error occurs when COM2 reads data from slave 6 by Modbus.	R	ON: when the Modbus connection is enabled and an error occurs in the reading of data from slave 6.
SM1790	An error occurs when COM2 reads data from slave 7 by Modbus.	R	ON: when the Modbus connection is enabled and an error occurs in the reading of data from slave 7.
SM1791	An error occurs when COM2 reads data from slave 8 by Modbus.	R	ON: when the Modbus connection is enabled and an error occurs in the reading of data from slave 8.

Device	Name	R/W	Description
SM1792	An error occurs when COM2 reads data from slave 9 by Modbus.	R	ON: when the Modbus connection is enabled and an error occurs in the reading of data from slave 9.
SM1793	An error occurs when COM2 reads data from slave 10 by Modbus.	R	ON: when the Modbus connection is enabled and an error occurs in the reading of data from slave 10.
SM1794	An error occurs when COM2 reads data from slave 11 by Modbus.	R	ON: when the Modbus connection is enabled and an error occurs in the reading of data from slave 11.
SM1795	An error occurs when COM2 reads data from slave 12 by Modbus.	R	ON: when the Modbus connection is enabled and an error occurs in the reading of data from slave 12.
SM1796	An error occurs when COM2 reads data from slave 13 by Modbus.	R	ON: when the Modbus connection is enabled and an error occurs in the reading of data from slave 13.
SM1797	An error occurs when COM2 reads data from slave 14 by Modbus.	R	ON: when the Modbus connection is enabled and an error occurs in the reading of data from slave 14.
SM1798	An error occurs when COM2 reads data from slave 15 by Modbus.	R	ON: when the Modbus connection is enabled and an error occurs in the reading of data from slave 15.
SM1799	An error occurs when COM2 reads data from slave 16 by Modbus.	R	ON: when the Modbus connection is enabled and an error occurs in the reading of data from slave 16.
SM1800	An error occurs when COM2 reads data from slave 17 by Modbus.	R	ON: when the Modbus connection is enabled and an error occurs in the reading of data from slave 17.
SM1801	An error occurs when COM2 reads data from slave 18 by Modbus.	R	ON: when the Modbus connection is enabled and an error occurs in the reading of data from slave 18.
SM1802	An error occurs when COM2 reads data from slave 19 by Modbus.	R	ON: when the Modbus connection is enabled and an error occurs in the reading of data from slave 19.
SM1803	An error occurs when COM2 reads data from slave 20 by Modbus.	R	ON: when the Modbus connection is enabled and an error occurs in the reading of data from slave 20.
SM1804	An error occurs when COM2 reads data from slave 21 by Modbus.	R	ON: when the Modbus connection is enabled and an error occurs in the reading of data from slave 21.
SM1805	An error occurs when COM2 reads data from slave 22 by Modbus.	R	ON: when the Modbus connection is enabled and an error occurs in the reading of



Device	Name	R/W	Description
			data from slave 22.
SM1806	An error occurs when COM2 reads data from slave 23 by Modbus.	R	ON: when the Modbus connection is enabled and an error occurs in the reading of data from slave 23.
SM1807	An error occurs when COM2 reads data from slave 24 by Modbus.	R	ON: when the Modbus connection is enabled and an error occurs in the reading of data from slave 24.
SM1808	An error occurs when COM2 reads data from slave 25 by Modbus.	R	ON: when the Modbus connection is enabled and an error occurs in the reading of data from slave 25.
SM1809	An error occurs when COM2 reads data from slave 26 by Modbus.	R	ON: when the Modbus connection is enabled and an error occurs in the reading of data from slave 26.
SM1810	An error occurs when COM2 reads data from slave 27 by Modbus.	R	ON: when the Modbus connection is enabled and an error occurs in the reading of data from slave 27.
SM1811	An error occurs when COM2 reads data from slave 28 by Modbus.	R	ON: when the Modbus connection is enabled and an error occurs in the reading of data from slave 28.
SM1812	An error occurs when COM2 reads data from slave 29 by Modbus.	R	ON: when the Modbus connection is enabled and an error occurs in the reading of data from slave 29.
SM1813	An error occurs when COM2 reads data from slave 30 by Modbus.	R	ON: when the Modbus connection is enabled and an error occurs in the reading of data from slave 30.
SM1814	An error occurs when COM2 reads data from slave 31 by Modbus.	R	ON: when the Modbus connection is enabled and an error occurs in the reading of data from slave 31.
SM1815	An error occurs when COM2 reads data from slave 32 by Modbus.	R	ON: when the Modbus connection is enabled and an error occurs in the reading of data from slave 32.
SM1816	An error occurs when COM2 writes data to slave 1 by Modbus.	R	ON: when the Modbus connection is enabled and an error occurs in the writing of data to slave 1.
SM1817	An error occurs when COM2 writes data to slave 2 by Modbus.	R	ON: when the Modbus connection is enabled and an error occurs in the writing of data to slave 2.
SM1818	An error occurs when COM2 writes data to slave 3 by Modbus.	R	ON: when the Modbus connection is enabled and an error occurs in the writing of data to slave 3.
SM1819	An error occurs when COM2 writes data to slave 4 by Modbus.	R	ON: when the Modbus connection is enabled and an

Device	Name	R/W	Description
			error occurs in the writing of data to slave 4.
SM1820	An error occurs when COM2 writes data to slave 5 by Modbus.	R	ON: when the Modbus connection is enabled and an error occurs in the writing of data to slave 5.
SM1821	An error occurs when COM2 writes data to slave 6 by Modbus.	R	ON: when the Modbus connection is enabled and an error occurs in the writing of data to slave 6.
SM1822	An error occurs when COM2 writes data to slave 7 by Modbus.	R	ON: when the Modbus connection is enabled and an error occurs in the writing of data to slave 7.
SM1823	An error occurs when COM2 writes data to slave 8 by Modbus.	R	ON: when the Modbus connection is enabled and an error occurs in the writing of data to slave 8.
SM1824	An error occurs when COM2 writes data to slave 9 by Modbus.	R	ON: when the Modbus connection is enabled and an error occurs in the writing of data to slave 9.
SM1825	An error occurs when COM2 writes data to slave 10 by Modbus.	R	ON: when the Modbus connection is enabled and an error occurs in the writing of data to slave 10.
SM1826	An error occurs when COM2 writes data to slave 11 by Modbus.	R	ON: when the Modbus connection is enabled and an error occurs in the writing of data to slave 11.
SM1827	An error occurs when COM2 writes data to slave 12 by Modbus.	R	ON: when the Modbus connection is enabled and an error occurs in the writing of data to slave 12.
SM1828	An error occurs when COM2 writes data to slave 13 by Modbus.	R	ON: when the Modbus connection is enabled and an error occurs in the writing of data to slave 13.
SM1829	An error occurs when COM2 writes data to slave 14 by Modbus.	R	ON: when the Modbus connection is enabled and an error occurs in the writing of data to slave 14.
SM1830	An error occurs when COM2 writes data to slave 15 by Modbus.	R	ON: when the Modbus connection is enabled and an error occurs in the writing of data to slave 15.
SM1831	An error occurs when COM2 writes data to slave 16 by Modbus.	R	ON: when the Modbus connection is enabled and an error occurs in the writing of data to slave 16.
SM1832	An error occurs when COM2 writes data to slave 17 by Modbus.	R	ON: when the Modbus connection is enabled and an error occurs in the writing of data to slave 17.
SM1833	An error occurs when COM2 writes data to	R	ON: when the Modbus

11

Device	Name	R/W	Description
	slave 18 by Modbus.		connection is enabled and an error occurs in the writing of data to slave 18.
SM1834	An error occurs when COM2 writes data to slave 19 by Modbus.	R	ON: when the Modbus connection is enabled and an error occurs in the writing of data to slave 19.
SM1835	An error occurs when COM2 writes data to slave 20 by Modbus.	R	ON: when the Modbus connection is enabled and an error occurs in the writing of data to slave 20.
SM1836	An error occurs when COM2 writes data to slave 21 by Modbus.	R	ON: when the Modbus connection is enabled and an error occurs in the writing of data to slave 21.
SM1837	An error occurs when COM2 writes data to slave 22 by Modbus.	R	ON: when the Modbus connection is enabled and an error occurs in the writing of data to slave 22.
SM1838	An error occurs when COM2 writes data to slave 23 by Modbus.	R	ON: when the Modbus connection is enabled and an error occurs in the writing of data to slave 23.
SM1839	An error occurs when COM2 writes data to slave 24 by Modbus.	R	ON: when the Modbus connection is enabled and an error occurs in the writing of data to slave 24.
SM1840	An error occurs when COM2 writes data to slave 25 by Modbus.	R	ON: when the Modbus connection is enabled and an error occurs in the writing of data to slave 25.
SM1841	An error occurs when COM2 writes data to slave 26 by Modbus.	R	ON: when the Modbus connection is enabled and an error occurs in the writing of data to slave 26.
SM1842	An error occurs when COM2 writes data to slave 27 by Modbus.	R	ON: when the Modbus connection is enabled and an error occurs in the writing of data to slave 27.
SM1843	An error occurs when COM2 writes data to slave 28 by Modbus.	R	ON: when the Modbus connection is enabled and an error occurs in the writing of data to slave 28.
SM1844	An error occurs when COM2 writes data to slave 29 by Modbus.	R	ON: when the Modbus connection is enabled and an error occurs in the writing of data to slave 29.
SM1845	An error occurs when COM2 writes data to slave 30 by Modbus.	R	ON: when the Modbus connection is enabled and an error occurs in the writing of data to slave 30.
SM1846	An error occurs when COM2 writes data to slave 31 by Modbus.	R	ON: when the Modbus connection is enabled and an error occurs in the writing of data to slave 31.

Device	Name	R/W	Description
SM1847	An error occurs when COM2 writes data to slave 32 by Modbus.	R	ON: when the Modbus connection is enabled and an error occurs in the writing of data to slave 32.
SM1848	COM2 finishes reading data from slave 1 by Modbus.	R	ON: when a Modbus connection is enabled for COM2 and the master finishes reading data from slave 1.
SM1849	COM2 finishes reading data from slave 2 by Modbus.	R	ON: when a Modbus connection is enabled for COM2 and the master finishes reading data from slave 2.
SM1850	COM2 finishes reading data from slave 3 by Modbus.	R	ON: when a Modbus connection is enabled for COM2 and the master finishes reading data from slave 3.
SM1851	COM2 finishes reading data from slave 4 by Modbus.	R	ON: when a Modbus connection is enabled for COM2 and the master finishes reading data from slave 4.
SM1852	COM2 finishes reading data from slave 5 by Modbus.	R	ON: when a Modbus connection is enabled for COM2 and the master finishes reading data from slave 5.
SM1853	COM2 finishes reading data from slave 6 by Modbus.	R	ON: when a Modbus connection is enabled for COM2 and the master finishes reading data from slave 6.
SM1854	COM2 finishes reading data from slave 7 by Modbus.	R	ON: when a Modbus connection is enabled for COM2 and the master finishes reading data from slave 7.
SM1855	COM2 finishes reading data from slave 8 by Modbus.	R	ON: when a Modbus connection is enabled for COM2 and the master finishes reading data from slave 8.
SM1856	COM2 finishes reading data from slave 9 by Modbus.	R	ON: when a Modbus connection is enabled for COM2 and the master finishes reading data from slave 9.
SM1857	COM2 finishes reading data from slave 10 by Modbus.	R	ON: when a Modbus connection is enabled for COM2 and the master finishes reading data from slave 10.
SM1858	COM2 finishes reading data from slave 11 by Modbus.	R	ON: when a Modbus connection is enabled for COM2 and the master finishes reading data from slave 11.
SM1859	COM2 finishes reading data from slave 12 by Modbus.	R	ON: when a Modbus connection is enabled for COM2 and the master finishes reading data from slave 12.
SM1860	COM2 finishes reading data from slave 13 by Modbus.	R	ON: when a Modbus connection is enabled for COM2 and the master finishes



Device	Name	R/W	Description
			reading data from slave 13.
SM1861	COM2 finishes reading data from slave 14 by Modbus.	R	ON: when a Modbus connection is enabled for COM2 and the master finishes reading data from slave 14.
SM1862	COM2 finishes reading data from slave 15 by Modbus.	R	ON: when a Modbus connection is enabled for COM2 and the master finishes reading data from slave 15.
SM1863	COM2 finishes reading data from slave 16 by Modbus.	R	ON: when a Modbus connection is enabled for COM2 and the master finishes reading data from slave 16.
SM1864	COM2 finishes reading data from slave 17 by Modbus.	R	ON: when a Modbus connection is enabled for COM2 and the master finishes reading data from slave 17.
SM1865	COM2 finishes reading data from slave 18 by Modbus.	R	ON: when a Modbus connection is enabled for COM2 and the master finishes reading data from slave 18.
SM1866	COM2 finishes reading data from slave 19 by Modbus.	R	ON: when a Modbus connection is enabled for COM2 and the master finishes reading data from slave 19.
SM1867	COM2 finishes reading data from slave 20 by Modbus.	R	ON: when a Modbus connection is enabled for COM2 and the master finishes reading data from slave 20.
SM1868	COM2 finishes reading data from slave 21 by Modbus.	R	ON: when a Modbus connection is enabled for COM2 and the master finishes reading data from slave 21.
SM1869	COM2 finishes reading data from slave 22 by Modbus.	R	ON: when a Modbus connection is enabled for COM2 and the master finishes reading data from slave 22.
SM1870	COM2 finishes reading data from slave 23 by Modbus.	R	ON: when a Modbus connection is enabled for COM2 and the master finishes reading data from slave 23.
SM1871	COM2 finishes reading data from slave 24 by Modbus.	R	ON: when a Modbus connection is enabled for COM2 and the master finishes reading data from slave 24.
SM1872	COM2 finishes reading data from slave 25 by Modbus.	R	ON: when a Modbus connection is enabled for COM2 and the master finishes reading data from slave 25.
SM1873	COM2 finishes reading data from slave 26 by Modbus.	R	ON: when a Modbus connection is enabled for COM2 and the master finishes reading data from slave 26.
SM1874	COM2 finishes reading data from slave 27 by Modbus.	R	ON: when a Modbus connection is enabled for

Device	Name	R/W	Description
			COM2 and the master finishes reading data from slave 27.
SM1875	COM2 finishes reading data from slave 28 by Modbus.	R	ON: when a Modbus connection is enabled for COM2 and the master finishes reading data from slave 28.
SM1876	COM2 finishes reading data from slave 29 by Modbus.	R	ON: when a Modbus connection is enabled for COM2 and the master finishes reading data from slave 29.
SM1877	COM2 finishes reading data from slave 30 by Modbus.	R	ON: when a Modbus connection is enabled for COM2 and the master finishes reading data from slave 30.
SM1878	COM2 finishes reading data from slave 31 by Modbus.	R	ON: when a Modbus connection is enabled for COM2 and the master finishes reading data from slave 31.
SM1879	COM2 finishes reading data from slave 32 by Modbus.	R	ON: when a Modbus connection is enabled for COM2 and the master finishes reading data from slave 32.
SM1880	COM2 finishes writing data to slave 1 by Modbus.	R	ON: when a Modbus connection is enabled for COM2 and the master finishes writing data to slave 1.
SM1881	COM2 finishes writing data to slave 2 by Modbus.	R	ON: when a Modbus connection is enabled for COM2 and the master finishes writing data to slave 2.
SM1882	COM2 finishes writing data to slave 3 by Modbus.	R	ON: when a Modbus connection is enabled for COM2 and the master finishes writing data to slave 3.
SM1883	COM2 finishes writing data to slave 4 by Modbus.	R	ON: when a Modbus connection is enabled for COM2 and the master finishes writing data to slave 4.
SM1884	COM2 finishes writing data to slave 5 by Modbus.	R	ON: when a Modbus connection is enabled for COM2 and the master finishes writing data to slave 5.
SM1885	COM2 finishes writing data to slave 6 by Modbus.	R	ON: when a Modbus connection is enabled for COM2 and the master finishes writing data to slave 6.
SM1886	COM2 finishes writing data to slave 7 by Modbus.	R	ON: when a Modbus connection is enabled for COM2 and the master finishes writing data to slave 7.
SM1887	COM2 finishes writing data to slave 8 by Modbus.	R	ON: when a Modbus connection is enabled for COM2 and the master finishes writing data to slave 8.
SM1888	COM2 finishes writing data to slave 9 by	R	ON: when a Modbus

11

Device	Name	R/W	Description
	Modbus.		connection is enabled for COM2 and the master finishes writing data to slave 9.
SM1889	COM2 finishes writing data to slave 10 by Modbus.	R	ON: when a Modbus connection is enabled for COM2 and the master finishes writing data to slave 10.
SM1890	COM2 finishes writing data to slave 11 by Modbus.	R	ON: when a Modbus connection is enabled for COM2 and the master finishes writing data to slave 11.
SM1891	COM2 finishes writing data to slave 12 by Modbus.	R	ON: when a Modbus connection is enabled for COM2 and the master finishes writing data to slave 12.
SM1892	COM2 finishes writing data to slave 13 by Modbus.	R	ON: when a Modbus connection is enabled for COM2 and the master finishes writing data to slave 13.
SM1893	COM2 finishes writing data to slave 14 by Modbus.	R	ON: when a Modbus connection is enabled for COM2 and the master finishes writing data to slave 14.
SM1894	COM2 finishes writing data to slave 15 by Modbus.	R	ON: when a Modbus connection is enabled for COM2 and the master finishes writing data to slave 15.
SM1895	COM2 finishes writing data to slave 16 by Modbus.	R	ON: when a Modbus connection is enabled for COM2 and the master finishes writing data to slave 16.
SM1896	COM2 finishes writing data to slave 17 by Modbus.	R	ON: when a Modbus connection is enabled for COM2 and the master finishes writing data to slave 17.
SM1897	COM2 finishes writing data to slave 18 by Modbus.	R	ON: when a Modbus connection is enabled for COM2 and the master finishes writing data to slave 18.
SM1898	COM2 finishes writing data to slave 19 by Modbus.	R	ON: when a Modbus connection is enabled for COM2 and the master finishes writing data to slave 19.
SM1899	COM2 finishes writing data to slave 20 by Modbus.	R	ON: when a Modbus connection is enabled for COM2 and the master finishes writing data to slave 20.
SM1900	COM2 finishes writing data to slave 21 by Modbus.	R	ON: when a Modbus connection is enabled for COM2 and the master finishes writing data to slave 21.
SM1901	COM2 finishes writing data to slave 22 by Modbus.	R	ON: when a Modbus connection is enabled for COM2 and the master finishes writing data to slave 22.

Device	Name	R/W	Description
SM1902	COM2 finishes writing data to slave 23 by Modbus.	R	ON: when a Modbus connection is enabled for COM2 and the master finishes writing data to slave 23.
SM1903	COM2 finishes writing data to slave 24 by Modbus.	R	ON: when a Modbus connection is enabled for COM2 and the master finishes writing data to slave 24.
SM1904	COM2 finishes writing data to slave 25 by Modbus.	R	ON: when a Modbus connection is enabled for COM2 and the master finishes writing data to slave 25.
SM1905	COM2 finishes writing data to slave 26 by Modbus.	R	ON: when a Modbus connection is enabled for COM2 and the master finishes writing data to slave 26.
SM1906	COM2 finishes writing data to slave 27 by Modbus.	R	ON: when a Modbus connection is enabled for COM2 and the master finishes writing data to slave 27.
SM1907	COM2 finishes writing data to slave 28 by Modbus.	R	ON: when a Modbus connection is enabled for COM2 and the master finishes writing data to slave 28.
SM1908	COM2 finishes writing data to slave 29 by Modbus.	R	ON: when a Modbus connection is enabled for COM2 and the master finishes writing data to slave 29.
SM1909	COM2 finishes writing data to slave 30 by Modbus.	R	ON: when a Modbus connection is enabled for COM2 and the master finishes writing data to slave 30.
SM1910	COM2 finishes writing data to slave 31 by Modbus.	R	ON: when a Modbus connection is enabled for COM2 and the master finishes writing data to slave 31.
SM1911	COM2 finishes writing data to slave 32 by Modbus.	R	ON: when a Modbus connection is enabled for COM2 and the master finishes writing data to slave 32.

11

11.3.2 MODBUS TCP Data Exchange

11.3.2.1 MODBUS TCP Data Exchange

Data exchange between electronic devices can be achieved via MODBUS TCP protocol. Through MODBUS TCP protocol, users can exchange data among Delta devices and any 3rd party devices, as long as they comply with the MODBUS TCP standard. A chart showing information concerning MODBUS TCP data exchange is provided below.

Communication mode	MODBUS TCP	
Maximum number of connections ^{*1}	AHCPU500-EN	16
	AHCPU510-EN & AHCPU511-EN	32
	AHCPU520-EN & AHCPU521-EN	64
	AHCPU530-EN & AHCPU531-EN	128

11

Communication protocol	Standard Modbus TCP/IP and AH communication protocol		
Maximum quantity of data which can be read/written	Remote terminal unit	AH500 series CPU module	400 words 6400 bits
		DVP series PLCs	100 words 100 bits
		Others	100 words 100 bits
Supported devices	Remote terminal unit	AH500 series CPU module	X, Y, M, SM, SR, D, T, C, S, E
		DVP series PLCs	X, Y, M, D
		Others	Logical address 0x0000~0xFFFF
Supported models	AHCPU500-EN, AHCPU510-EN, AHCPU520-EN, AHCPU530-EN, AHCPU511-EN, AHCPU521-EN, AHCPU531-EN		

*1. The maximum number of connections is equal to the number of Modbus TCP data exchange blocks plus the number of Ether Link data exchange blocks. The number of Ether Link data exchange blocks in a PLC is the number of nodes of which the PLC demands data, and the nodes to which the PLC provides data are not counted.

11.3.2.2 MODBUS TCP Data Exchange - PLC Parameter Setting

Double-click **HWCONFIG**, and then double-click **CPU**. After **CPU** is double-clicked, the **PLC Parameter Setting** window will be opened.

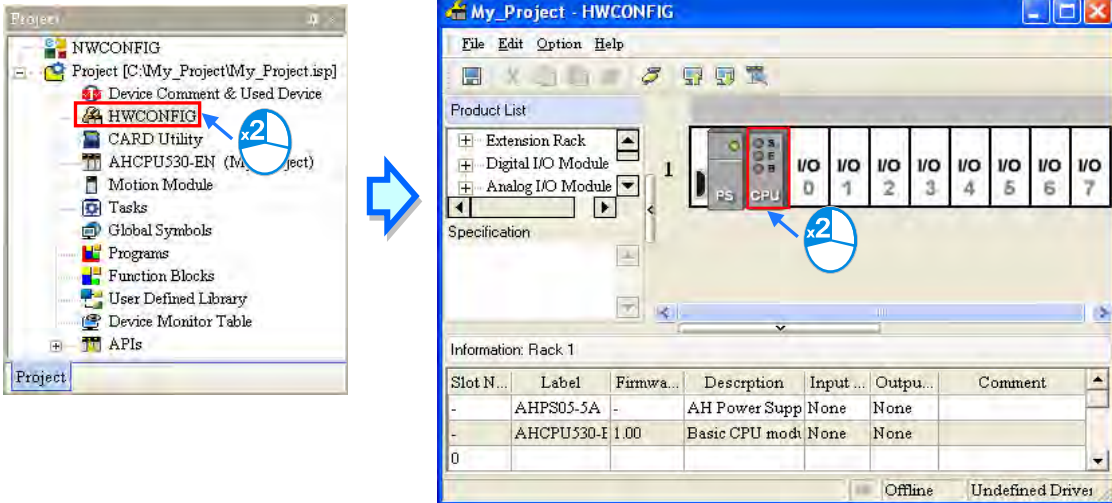

◆ AH500 basic CPU series (AHCPU500/510/520/530)

Click the **Ethernet-Advance** tab, and then click the **Data Exchange** tab.

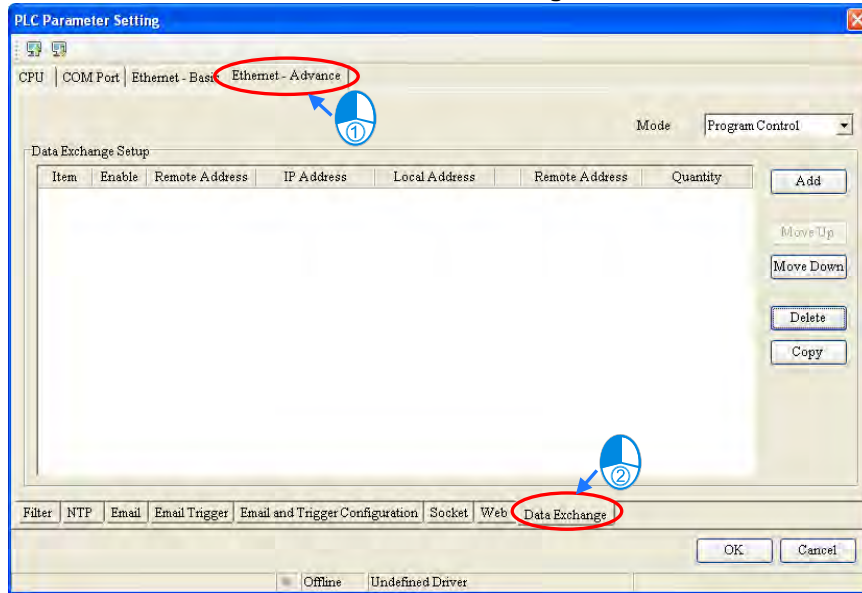

11

Owing to the fact that no data is set, there is a blank table in the **Data Exchange Setup** section. After **Add** is clicked, an item will be inserted. After the item is double-clicked, the **Item 1** window will appear.

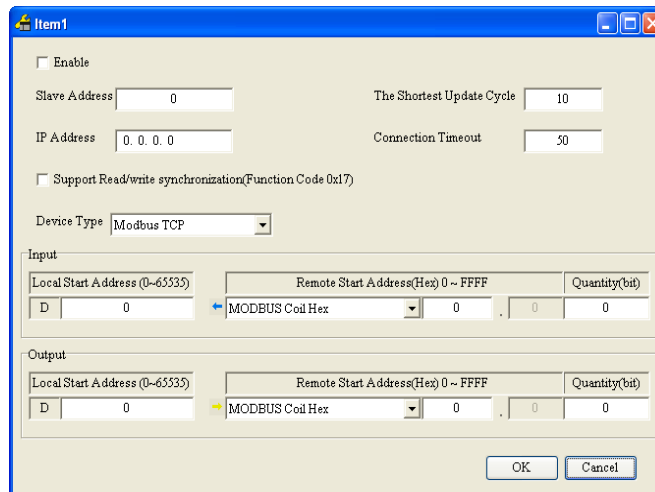
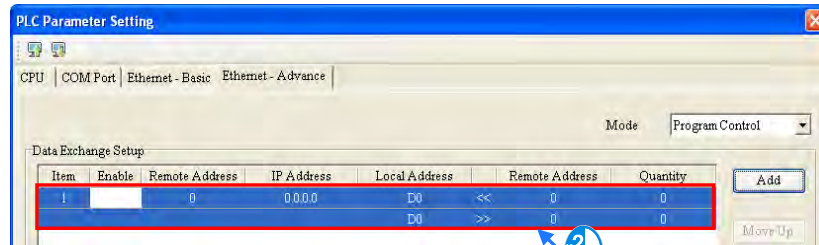
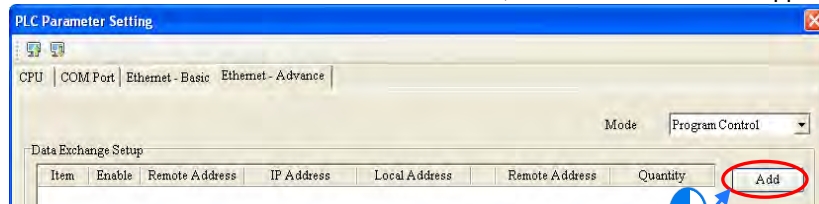

11

◆ AH500 advanced CPU series (AHCPU511/521/531)

Click the **Data Exchange Setup - Ethernet** tab.

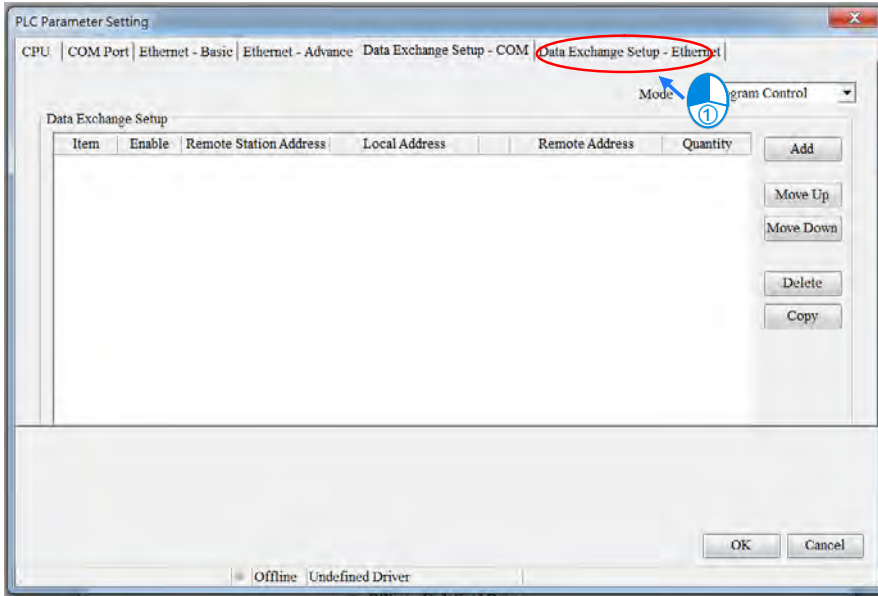

Owing to the fact that no data is set, there is a blank table in the **Data Exchange Setup** section. After **Add** is clicked, an item will be inserted. After the item is double-clicked, the **Item 1** window will appear.

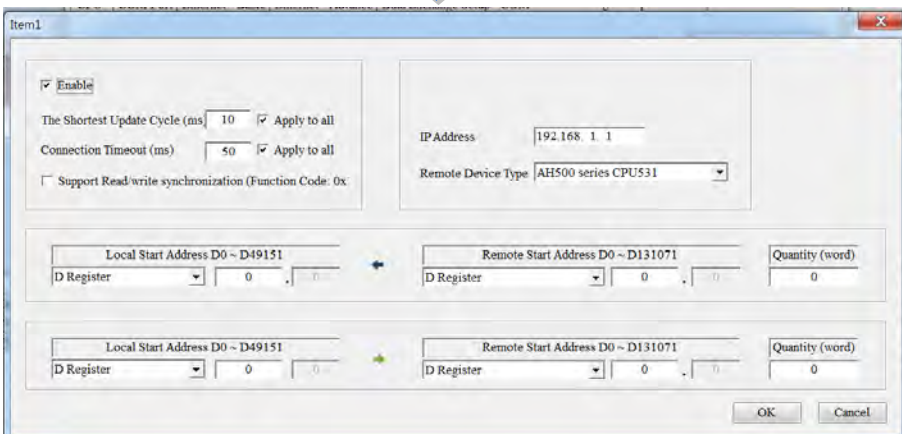
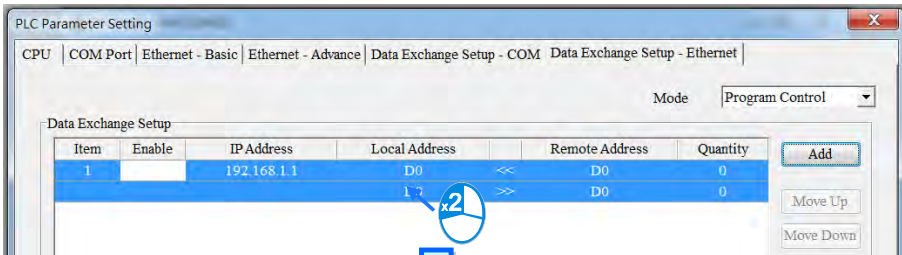
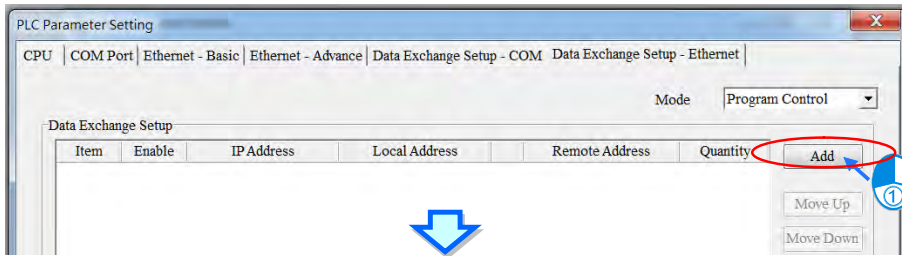

The **Item 1** window is described below.

- **Enable**
If users want to make the PLC execute the data exchange, they have to select the **Enable** checkbox. If the users want to stop the data exchange temporarily, they can leave the **Enable** checkbox unselected.
- **IP Address**
Users have to type the IP address of the slave to which the PLC will connect in the **IP Address** box.
- **The Shortest Update Cycle (ms)**
Users have to set the shortest cycle of updating the data exchange. A millisecond is a unit of time. When the data exchange is executed, it is updated at specific intervals. However, if the data exchange is prolonged due to network congestion or other reasons, it will be updated according to the actual situation.
- **Connection Timeout (ms)**
Users can set the longest time that is allowed to elapse before the data exchange is executed. A millisecond is a unit of time. If the data exchange is not executed after the longest time set elapses, a connection timeout will occur. The PLC still tries to connect to the slave station selected at specific intervals. Once the PLC connects to the slave station selected, the data exchange will be executed.
- **Support read/write synchronization (Function code 0x17)**
If the slave to which the PLC will connect can complete reading and writing simultaneously (Modbus function code 0x17), users can select the **Support read/write synchronization (Function code 0x17)** checkbox. After the **Support read/write synchronization (Function code 0x17)** checkbox is selected, the PLC will read data and write data simultaneously, and the efficiency in exchanging data will increase.
- **Device Type**
Users can select the model of the slave to which the PLC will connect in the **Device Type** drop-down list box. They can select a standard Modbus TCP device or a Delta PLC. If they select a Delta PLC, they can use the registers in the Delta PLC when they set data blocks. When selecting a 3rd party device, they can select MODBUS Register Hex from the Remote Start Address (Hex) drop-down list and define a hexadecimal 4-digit MODBUS absolute position.
- **Input**
Users can set the register in which the data read will be stored in the **Local Start Address** box. The register set can only be a D device (not limited to AH500 advanced CPU series: AHCPU511/521/531). The users can set the register whose contents will be read in the **Remote Start Address** box. The register and the address which can be set depend on the device type selected in the **Device Type** drop-down list box. The users can set the quantity of data which will be read in the **Quantity** box. For AH500 basic CPU series (AHCPU500/510/520/530), the unit used depends on the remote register type selected. 100 words (1600 bits) at most can be read. However, if the slave to which the PLC will connect is an AH500 series CPU module, 400 words (6400 bits) at most can be read. As for AH500 advanced CPU series (AHCPU511/521/531), users can select the register type according to the requirements.
- **Output**
Users can set the register whose contents will be written in the **Local Start Address** box. The register set can only be a D device (not limited to AH500 advanced CPU series: AHCPU511/521/531). The users can set the register into which data will be written in the **Remote Start Address** box. The register and the address which can be set depend on the device type selected in the **Device Type** drop-down list box. The users can set the quantity of data which will be written in the **Quantity** box. For AH500 basic CPU series (AHCPU500/510/520/530), the unit used depends on the remote register type selected. 100 words (1600 bits) at most can be written. However, if the slave to which the PLC will connect is an AH500 series CPU module, 400 words (6400 bits) at most can be written. As for AH500 advanced CPU series (AHCPU511/521/531), users can select the register type according to the requirements.

When users set a data exchange block, the local register set can only be a word device, and the remote register set can be a bit device. If the remote register set is a bit device, the device number of the remote register does not need to end with 0. For example, the remote register set can be D0.3. If the data which will be read or written is not composed of words, the local PLC will exchange bits with the remote PLC selected, and the bits which are not involved in the data exchange will remain unchanged. For example, if D0~D1 in the local PLC read M0~M19 in the remote PLC selected, the data read will be stored in D0.0~D1.3, and D1.4~D1.5 will remain unchanged. As for AH500 advanced CPU series (AHCPU511/521/531), users can select the register type according to the requirements.

11

After the users set a data exchange block, they have to click **OK**. The users can use this method to create several data exchange blocks.

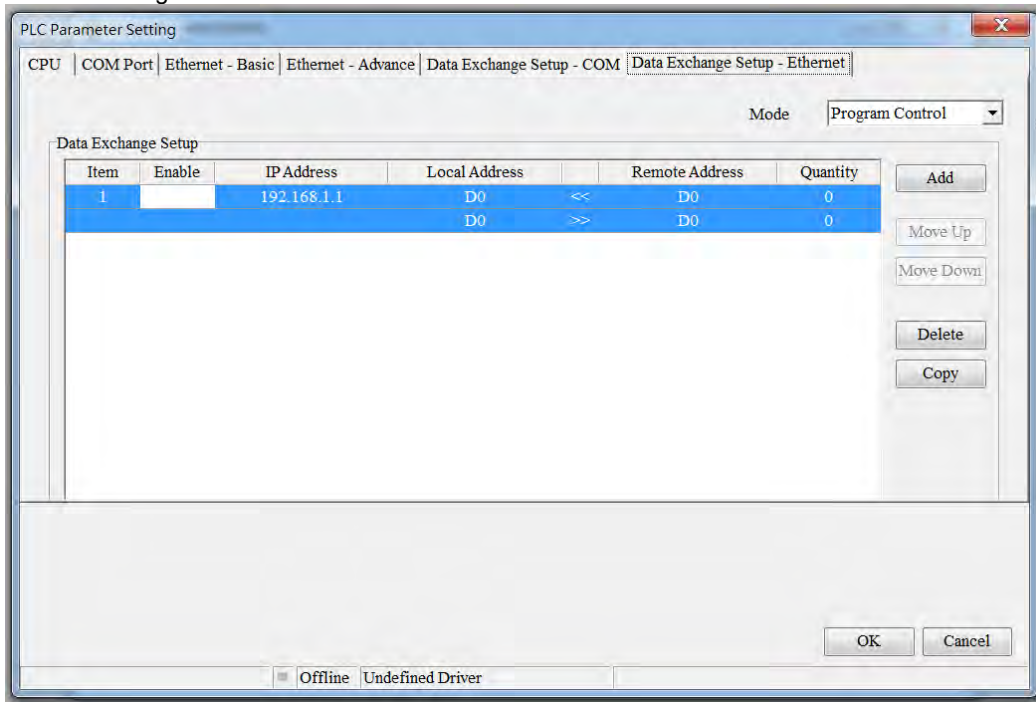

The users can manage the items in the table by means of the buttons at the right side of the table. The buttons are described below.

Button	Description
Move Up	Moving the item selected in the table upwards
Move Down	Moving the item selected in the table downwards
Delete	Deleting the item selected in the table
Copy	Copying the item selected in the table, and automatically adding the item which is copied to the bottom of the table

After the users create a data exchange table, they can select a mode in the **Mode** drop-down list box.

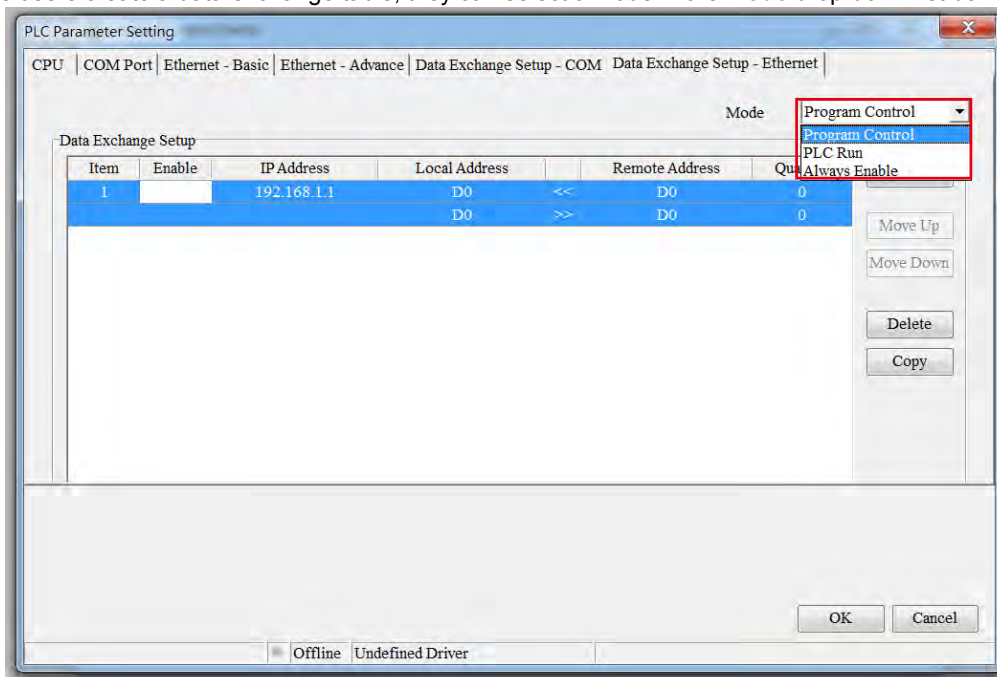

Mode	Description
Program Control	The execution of the data exchange is enabled or disabled by means of setting flags* ² . If the flags are set to ON, the execution of the data exchange will be enabled.
PLC Run	When the PLC runs, the data exchange is executed.
Always Enable	The data exchange is executed whether the PLC runs or stops.

*1. The mode selected will be executed only if the Enable checkbox in the window used to set an item is selected.



*2. Please refer to section 11.3.3 for more information about setting flags.

11

11.3.2.3 MODBUS TCP Data Exchange - Downloading/Uploading Parameters

After users set data exchange blocks, they have to download the parameters which are set to the PLC used. This section briefly introduces the downloading/uploading of the parameters set. Please refer to chapter 3 in ISPSOFT User Manual for more information. Before the users download the parameters which are set, they have to make sure that ISPSOFT connects to the PLC used normally. Please refer to section 2.4 in ISPSOFT User Manual for more information.

◆ AH500 basic CPU series (AHCPU500/510/520/530)

After the users click  in the upper left corner of the **PLC Parameter Setting** window, parameters set will be downloaded. After the users click  in the upper left corner of the **PLC Parameter Setting** window, parameters in the PLC used will be uploaded.

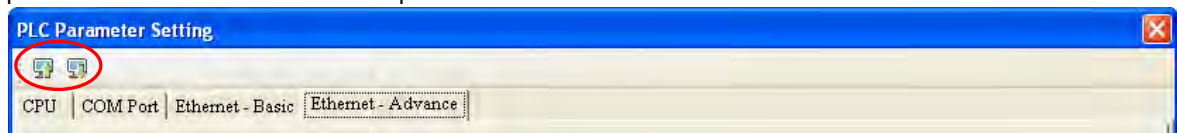

After the users select the **Ethernet-Advance** checkbox, and click **OK** in the **Transfer Setup** window, the parameters related to the **Ethernet-Advance** checkbox will be downloaded or uploaded, including the parameters related to the data exchange set in the previous section.

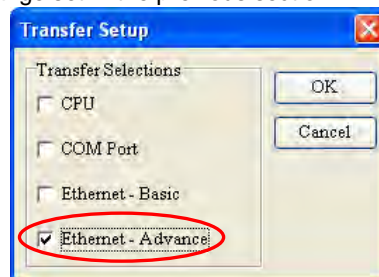

◆ **AH500 advanced CPU series (AHCPU511/521/531)**

When the setups are done, make sure to click OK to confirm and save the settings.

11

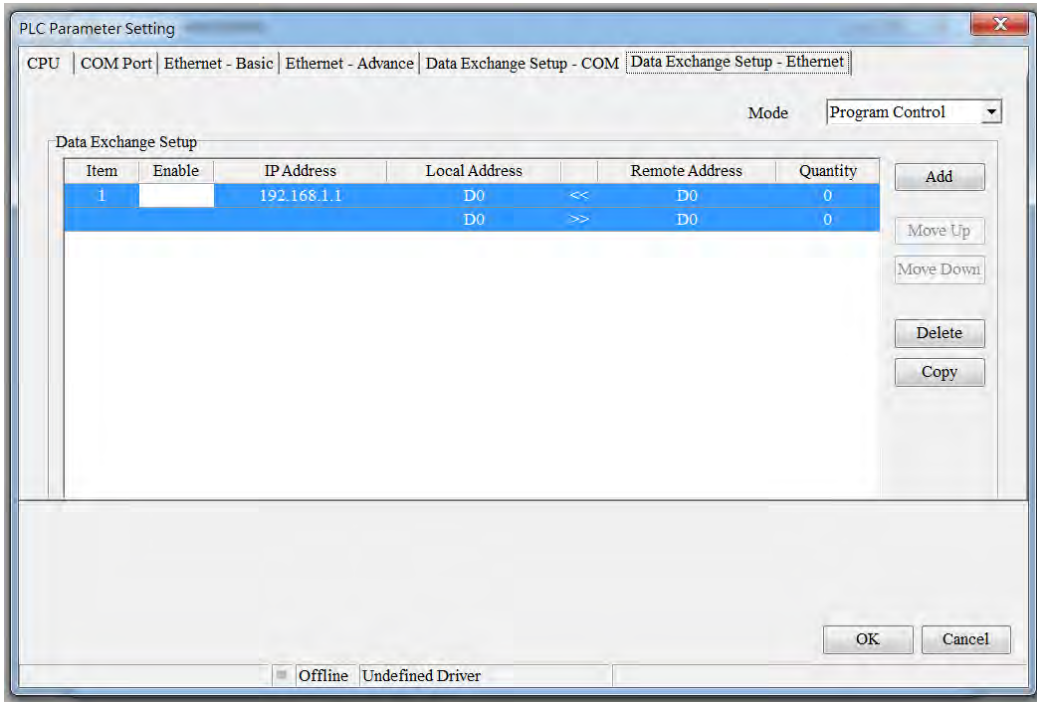

After the users click  in the **PLC Parameter Setting** window, parameters set will be downloaded. After the users click  in the upper left corner of the **PLC Parameter Setting** window, parameters in the PLC used will be uploaded.



After the users select the **Data Exchange-COM** checkbox, and click **OK** in the **Transfer Setup** window, the parameters related to the **Data Exchange-COM** checkbox will be downloaded or uploaded, including the parameters related to the data exchange set in the previous section.

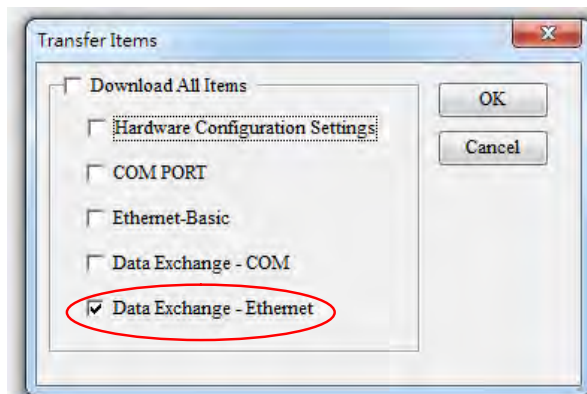

11.3.2.4 MODBUS TCP Data Exchange – Special Auxiliary Relays

◆ AH500 basic CPU series (AHCPU500/510/520/530)

Device	Name	R/W	Description
SM700	Enabling the execution of data exchange 1	R/W	ON: Enabling the execution of the data exchange OFF: Disabling the execution of the data exchange
SM701	Enabling the execution of data exchange 2	R/W	ON: Enabling the execution of the data exchange OFF: Disabling the execution of the data exchange
SM702	Enabling the execution of data exchange 3	R/W	ON: Enabling the execution of the data exchange OFF: Disabling the execution of the data exchange
SM703	Enabling the execution of data exchange 4	R/W	ON: Enabling the execution of the data exchange OFF: Disabling the execution of the data exchange
SM704	Enabling the execution of data exchange 5	R/W	ON: Enabling the execution of the data exchange OFF: Disabling the execution of the data exchange
SM705	Enabling the execution of data exchange 6	R/W	ON: Enabling the execution of the data exchange OFF: Disabling the execution of the data exchange
SM706	Enabling the execution of data exchange 7	R/W	ON: Enabling the execution of the data exchange OFF: Disabling the execution of the data exchange
SM707	Enabling the execution of data exchange 8	R/W	ON: Enabling the execution of the data exchange OFF: Disabling the execution of the data exchange
SM708	Enabling the execution of data exchange 9	R/W	ON: Enabling the execution of the data exchange OFF: Disabling the execution of the data exchange
SM709	Enabling the execution of data exchange 10	R/W	ON: Enabling the execution of the data exchange OFF: Disabling the execution of the data exchange
SM710	Enabling the execution of data exchange 11	R/W	ON: Enabling the execution of the data exchange OFF: Disabling the execution of the data exchange
SM711	Enabling the execution of data exchange 12	R/W	ON: Enabling the execution of the data exchange OFF: Disabling the execution of the data exchange
SM712	Enabling the execution of data exchange 13	R/W	ON: Enabling the execution of the data exchange OFF: Disabling the execution of the data exchange
SM713	Enabling the execution of data exchange 14	R/W	ON: Enabling the execution of the data exchange OFF: Disabling the execution of the data exchange
SM714	Enabling the execution of data exchange 15	R/W	ON: Enabling the execution of the data exchange OFF: Disabling the execution of the data exchange
SM715	Enabling the execution of data exchange 16	R/W	ON: Enabling the execution of the data exchange OFF: Disabling the execution of the data exchange
SM716	Enabling the execution of data exchange 17	R/W	ON: Enabling the execution of the data exchange OFF: Disabling the execution of the data exchange
SM717	Enabling the execution of data	R/W	ON: Enabling the execution of the data exchange



Device	Name	R/W	Description
			exchange
SM791	Enabling the execution of data exchange 92	R/W	ON: Enabling the execution of the data exchange OFF: Disabling the execution of the data exchange
SM792	Enabling the execution of data exchange 93	R/W	ON: Enabling the execution of the data exchange OFF: Disabling the execution of the data exchange
SM793	Enabling the execution of data exchange 94	R/W	ON: Enabling the execution of the data exchange OFF: Disabling the execution of the data exchange
SM794	Enabling the execution of data exchange 95	R/W	ON: Enabling the execution of the data exchange OFF: Disabling the execution of the data exchange
SM795	Enabling the execution of data exchange 96	R/W	ON: Enabling the execution of the data exchange OFF: Disabling the execution of the data exchange
SM796	Enabling the execution of data exchange 97	R/W	ON: Enabling the execution of the data exchange OFF: Disabling the execution of the data exchange
SM797	Enabling the execution of data exchange 98	R/W	ON: Enabling the execution of the data exchange OFF: Disabling the execution of the data exchange
SM798	Enabling the execution of data exchange 99	R/W	ON: Enabling the execution of the data exchange OFF: Disabling the execution of the data exchange
SM799	Enabling the execution of data exchange 100	R/W	ON: Enabling the execution of the data exchange OFF: Disabling the execution of the data exchange
SM800	Enabling the execution of data exchange 101	R/W	ON: Enabling the execution of the data exchange OFF: Disabling the execution of the data exchange
SM801	Enabling the execution of data exchange 102	R/W	ON: Enabling the execution of the data exchange OFF: Disabling the execution of the data exchange
SM802	Enabling the execution of data exchange 103	R/W	ON: Enabling the execution of the data exchange OFF: Disabling the execution of the data exchange
SM803	Enabling the execution of data exchange 104	R/W	ON: Enabling the execution of the data exchange OFF: Disabling the execution of the data exchange
SM804	Enabling the execution of data exchange 105	R/W	ON: Enabling the execution of the data exchange OFF: Disabling the execution of the data exchange
SM805	Enabling the execution of data exchange 106	R/W	ON: Enabling the execution of the data exchange OFF: Disabling the execution of the data exchange
SM806	Enabling the execution of data exchange 107	R/W	ON: Enabling the execution of the data exchange OFF: Disabling the execution of the data exchange
SM807	Enabling the execution of data exchange 108	R/W	ON: Enabling the execution of the data exchange OFF: Disabling the execution of the data exchange
SM808	Enabling the execution of data exchange 109	R/W	ON: Enabling the execution of the data exchange OFF: Disabling the execution of the data exchange



Device	Name	R/W	Description
	exchange 128		OFF: Disabling the execution of the data exchange
SM828	Error flag for data exchange 1	R	ON: An error occurs when the data exchange is executed. OFF: No error occurs when the data exchange is executed.
SM829	Error flag for data exchange 2	R	ON: An error occurs when the data exchange is executed. OFF: No error occurs when the data exchange is executed.
SM830	Error flag for data exchange 3	R	ON: An error occurs when the data exchange is executed. OFF: No error occurs when the data exchange is executed.
SM831	Error flag for data exchange 4	R	ON: An error occurs when the data exchange is executed. OFF: No error occurs when the data exchange is executed.
SM832	Error flag for data exchange 5	R	ON: An error occurs when the data exchange is executed. OFF: No error occurs when the data exchange is executed.
SM833	Error flag for data exchange 6	R	ON: An error occurs when the data exchange is executed. OFF: No error occurs when the data exchange is executed.
SM834	Error flag for data exchange 7	R	ON: An error occurs when the data exchange is executed. OFF: No error occurs when the data exchange is executed.
SM835	Error flag for data exchange 8	R	ON: An error occurs when the data exchange is executed. OFF: No error occurs when the data exchange is executed.
SM836	Error flag for data exchange 9	R	ON: An error occurs when the data exchange is executed. OFF: No error occurs when the data exchange is executed.
SM837	Error flag for data exchange 10	R	ON: An error occurs when the data exchange is executed. OFF: No error occurs when the data exchange is executed.
SM838	Error flag for data exchange 11	R	ON: An error occurs when the data exchange is executed. OFF: No error occurs when the data exchange is executed.
SM839	Error flag for data exchange 12	R	ON: An error occurs when the data exchange is executed. OFF: No error occurs when the data exchange is executed.
SM840	Error flag for data exchange 13	R	ON: An error occurs when the data exchange is executed. OFF: No error occurs when the data exchange is executed.
SM841	Error flag for data exchange 14	R	ON: An error occurs when the data exchange is

Device	Name	R/W	Description
			executed. OFF: No error occurs when the data exchange is executed.
SM842	Error flag for data exchange 15	R	ON: An error occurs when the data exchange is executed. OFF: No error occurs when the data exchange is executed.
SM843	Error flag for data exchange 16	R	ON: An error occurs when the data exchange is executed. OFF: No error occurs when the data exchange is executed.
SM844	Error flag for data exchange 17	R	ON: An error occurs when the data exchange is executed. OFF: No error occurs when the data exchange is executed.
SM845	Error flag for data exchange 18	R	ON: An error occurs when the data exchange is executed. OFF: No error occurs when the data exchange is executed.
SM846	Error flag for data exchange 19	R	ON: An error occurs when the data exchange is executed. OFF: No error occurs when the data exchange is executed.
SM847	Error flag for data exchange 20	R	ON: An error occurs when the data exchange is executed. OFF: No error occurs when the data exchange is executed.
SM848	Error flag for data exchange 21	R	ON: An error occurs when the data exchange is executed. OFF: No error occurs when the data exchange is executed.
SM849	Error flag for data exchange 22	R	ON: An error occurs when the data exchange is executed. OFF: No error occurs when the data exchange is executed.
SM850	Error flag for data exchange 23	R	ON: An error occurs when the data exchange is executed. OFF: No error occurs when the data exchange is executed.
SM851	Error flag for data exchange 24	R	ON: An error occurs when the data exchange is executed. OFF: No error occurs when the data exchange is executed.
SM852	Error flag for data exchange 25	R	ON: An error occurs when the data exchange is executed. OFF: No error occurs when the data exchange is executed.
SM853	Error flag for data exchange 26	R	ON: An error occurs when the data exchange is executed. OFF: No error occurs when the data exchange is executed.
SM854	Error flag for data exchange 27	R	ON: An error occurs when the data exchange is executed. OFF: No error occurs when the data exchange is executed.



Device	Name	R/W	Description
SM855	Error flag for data exchange 28	R	ON: An error occurs when the data exchange is executed. OFF: No error occurs when the data exchange is executed.
SM856	Error flag for data exchange 29	R	ON: An error occurs when the data exchange is executed. OFF: No error occurs when the data exchange is executed.
SM857	Error flag for data exchange 30	R	ON: An error occurs when the data exchange is executed. OFF: No error occurs when the data exchange is executed.
SM858	Error flag for data exchange 31	R	ON: An error occurs when the data exchange is executed. OFF: No error occurs when the data exchange is executed.
SM859	Error flag for data exchange 32	R	ON: An error occurs when the data exchange is executed. OFF: No error occurs when the data exchange is executed.
SM860	Error flag for data exchange 33	R	ON: An error occurs when the data exchange is executed. OFF: No error occurs when the data exchange is executed.
SM861	Error flag for data exchange 34	R	ON: An error occurs when the data exchange is executed. OFF: No error occurs when the data exchange is executed.
SM862	Error flag for data exchange 35	R	ON: An error occurs when the data exchange is executed. OFF: No error occurs when the data exchange is executed.
SM863	Error flag for data exchange 36	R	ON: An error occurs when the data exchange is executed. OFF: No error occurs when the data exchange is executed.
SM864	Error flag for data exchange 37	R	ON: An error occurs when the data exchange is executed. OFF: No error occurs when the data exchange is executed.
SM865	Error flag for data exchange 38	R	ON: An error occurs when the data exchange is executed. OFF: No error occurs when the data exchange is executed.
SM866	Error flag for data exchange 39	R	ON: An error occurs when the data exchange is executed. OFF: No error occurs when the data exchange is executed.
SM867	Error flag for data exchange 40	R	ON: An error occurs when the data exchange is executed. OFF: No error occurs when the data exchange is executed.
SM868	Error flag for data exchange 41	R	ON: An error occurs when the data exchange is executed. OFF: No error occurs when the data exchange is

Device	Name	R/W	Description
			executed.
SM869	Error flag for data exchange 42	R	ON: An error occurs when the data exchange is executed. OFF: No error occurs when the data exchange is executed.
SM870	Error flag for data exchange 43	R	ON: An error occurs when the data exchange is executed. OFF: No error occurs when the data exchange is executed.
SM871	Error flag for data exchange 44	R	ON: An error occurs when the data exchange is executed. OFF: No error occurs when the data exchange is executed.
SM872	Error flag for data exchange 45	R	ON: An error occurs when the data exchange is executed. OFF: No error occurs when the data exchange is executed.
SM873	Error flag for data exchange 46	R	ON: An error occurs when the data exchange is executed. OFF: No error occurs when the data exchange is executed.
SM874	Error flag for data exchange 47	R	ON: An error occurs when the data exchange is executed. OFF: No error occurs when the data exchange is executed.
SM875	Error flag for data exchange 48	R	ON: An error occurs when the data exchange is executed. OFF: No error occurs when the data exchange is executed.
SM876	Error flag for data exchange 49	R	ON: An error occurs when the data exchange is executed. OFF: No error occurs when the data exchange is executed.
SM877	Error flag for data exchange 50	R	ON: An error occurs when the data exchange is executed. OFF: No error occurs when the data exchange is executed.
SM878	Error flag for data exchange 51	R	ON: An error occurs when the data exchange is executed. OFF: No error occurs when the data exchange is executed.
SM879	Error flag for data exchange 52	R	ON: An error occurs when the data exchange is executed. OFF: No error occurs when the data exchange is executed.
SM880	Error flag for data exchange 53	R	ON: An error occurs when the data exchange is executed. OFF: No error occurs when the data exchange is executed.
SM881	Error flag for data exchange 54	R	ON: An error occurs when the data exchange is executed. OFF: No error occurs when the data exchange is executed.
SM882	Error flag for data exchange 55	R	ON: An error occurs when the data exchange is executed.



Device	Name	R/W	Description
			OFF: No error occurs when the data exchange is executed.
SM883	Error flag for data exchange 56	R	ON: An error occurs when the data exchange is executed. OFF: No error occurs when the data exchange is executed.
SM884	Error flag for data exchange 57	R	ON: An error occurs when the data exchange is executed. OFF: No error occurs when the data exchange is executed.
SM885	Error flag for data exchange 58	R	ON: An error occurs when the data exchange is executed. OFF: No error occurs when the data exchange is executed.
SM886	Error flag for data exchange 59	R	ON: An error occurs when the data exchange is executed. OFF: No error occurs when the data exchange is executed.
SM887	Error flag for data exchange 60	R	ON: An error occurs when the data exchange is executed. OFF: No error occurs when the data exchange is executed.
SM888	Error flag for data exchange 61	R	ON: An error occurs when the data exchange is executed. OFF: No error occurs when the data exchange is executed.
SM889	Error flag for data exchange 62	R	ON: An error occurs when the data exchange is executed. OFF: No error occurs when the data exchange is executed.
SM890	Error flag for data exchange 63	R	ON: An error occurs when the data exchange is executed. OFF: No error occurs when the data exchange is executed.
SM891	Error flag for data exchange 64	R	ON: An error occurs when the data exchange is executed. OFF: No error occurs when the data exchange is executed.
SM892	Error flag for data exchange 65	R	ON: An error occurs when the data exchange is executed. OFF: No error occurs when the data exchange is executed.
SM893	Error flag for data exchange 66	R	ON: An error occurs when the data exchange is executed. OFF: No error occurs when the data exchange is executed.
SM894	Error flag for data exchange 67	R	ON: An error occurs when the data exchange is executed. OFF: No error occurs when the data exchange is executed.
SM895	Error flag for data exchange 68	R	ON: An error occurs when the data exchange is executed. OFF: No error occurs when the data exchange is executed.
SM896	Error flag for data exchange 69	R	ON: An error occurs when the data exchange is

Device	Name	R/W	Description
			executed. OFF: No error occurs when the data exchange is executed.
SM897	Error flag for data exchange 70	R	ON: An error occurs when the data exchange is executed. OFF: No error occurs when the data exchange is executed.
SM898	Error flag for data exchange 71	R	ON: An error occurs when the data exchange is executed. OFF: No error occurs when the data exchange is executed.
SM899	Error flag for data exchange 72	R	ON: An error occurs when the data exchange is executed. OFF: No error occurs when the data exchange is executed.
SM900	Error flag for data exchange 73	R	ON: An error occurs when the data exchange is executed. OFF: No error occurs when the data exchange is executed.
SM901	Error flag for data exchange 74	R	ON: An error occurs when the data exchange is executed. OFF: No error occurs when the data exchange is executed.
SM902	Error flag for data exchange 75	R	ON: An error occurs when the data exchange is executed. OFF: No error occurs when the data exchange is executed.
SM903	Error flag for data exchange 76	R	ON: An error occurs when the data exchange is executed. OFF: No error occurs when the data exchange is executed.
SM904	Error flag for data exchange 77	R	ON: An error occurs when the data exchange is executed. OFF: No error occurs when the data exchange is executed.
SM905	Error flag for data exchange 78	R	ON: An error occurs when the data exchange is executed. OFF: No error occurs when the data exchange is executed.
SM906	Error flag for data exchange 79	R	ON: An error occurs when the data exchange is executed. OFF: No error occurs when the data exchange is executed.
SM907	Error flag for data exchange 80	R	ON: An error occurs when the data exchange is executed. OFF: No error occurs when the data exchange is executed.
SM908	Error flag for data exchange 81	R	ON: An error occurs when the data exchange is executed. OFF: No error occurs when the data exchange is executed.
SM909	Error flag for data exchange 82	R	ON: An error occurs when the data exchange is executed. OFF: No error occurs when the data exchange is executed.



Device	Name	R/W	Description
SM910	Error flag for data exchange 83	R	ON: An error occurs when the data exchange is executed. OFF: No error occurs when the data exchange is executed.
SM911	Error flag for data exchange 84	R	ON: An error occurs when the data exchange is executed. OFF: No error occurs when the data exchange is executed.
SM912	Error flag for data exchange 85	R	ON: An error occurs when the data exchange is executed. OFF: No error occurs when the data exchange is executed.
SM913	Error flag for data exchange 86	R	ON: An error occurs when the data exchange is executed. OFF: No error occurs when the data exchange is executed.
SM914	Error flag for data exchange 87	R	ON: An error occurs when the data exchange is executed. OFF: No error occurs when the data exchange is executed.
SM915	Error flag for data exchange 88	R	ON: An error occurs when the data exchange is executed. OFF: No error occurs when the data exchange is executed.
SM916	Error flag for data exchange 89	R	ON: An error occurs when the data exchange is executed. OFF: No error occurs when the data exchange is executed.
SM917	Error flag for data exchange 90	R	ON: An error occurs when the data exchange is executed. OFF: No error occurs when the data exchange is executed.
SM918	Error flag for data exchange 91	R	ON: An error occurs when the data exchange is executed. OFF: No error occurs when the data exchange is executed.
SM919	Error flag for data exchange 92	R	ON: An error occurs when the data exchange is executed. OFF: No error occurs when the data exchange is executed.
SM920	Error flag for data exchange 93	R	ON: An error occurs when the data exchange is executed. OFF: No error occurs when the data exchange is executed.
SM921	Error flag for data exchange 94	R	ON: An error occurs when the data exchange is executed. OFF: No error occurs when the data exchange is executed.
SM922	Error flag for data exchange 95	R	ON: An error occurs when the data exchange is executed. OFF: No error occurs when the data exchange is executed.
SM923	Error flag for data exchange 96	R	ON: An error occurs when the data exchange is executed. OFF: No error occurs when the data exchange is

Device	Name	R/W	Description
			executed.
SM924	Error flag for data exchange 97	R	ON: An error occurs when the data exchange is executed. OFF: No error occurs when the data exchange is executed.
SM925	Error flag for data exchange 98	R	ON: An error occurs when the data exchange is executed. OFF: No error occurs when the data exchange is executed.
SM926	Error flag for data exchange 99	R	ON: An error occurs when the data exchange is executed. OFF: No error occurs when the data exchange is executed.
SM927	Error flag for data exchange 100	R	ON: An error occurs when the data exchange is executed. OFF: No error occurs when the data exchange is executed.
SM928	Error flag for data exchange 101	R	ON: An error occurs when the data exchange is executed. OFF: No error occurs when the data exchange is executed.
SM929	Error flag for data exchange 102	R	ON: An error occurs when the data exchange is executed. OFF: No error occurs when the data exchange is executed.
SM930	Error flag for data exchange 103	R	ON: An error occurs when the data exchange is executed. OFF: No error occurs when the data exchange is executed.
SM931	Error flag for data exchange 104	R	ON: An error occurs when the data exchange is executed. OFF: No error occurs when the data exchange is executed.
SM932	Error flag for data exchange 105	R	ON: An error occurs when the data exchange is executed. OFF: No error occurs when the data exchange is executed.
SM933	Error flag for data exchange 106	R	ON: An error occurs when the data exchange is executed. OFF: No error occurs when the data exchange is executed.
SM934	Error flag for data exchange 107	R	ON: An error occurs when the data exchange is executed. OFF: No error occurs when the data exchange is executed.
SM935	Error flag for data exchange 108	R	ON: An error occurs when the data exchange is executed. OFF: No error occurs when the data exchange is executed.
SM936	Error flag for data exchange 109	R	ON: An error occurs when the data exchange is executed. OFF: No error occurs when the data exchange is executed.
SM937	Error flag for data exchange 110	R	ON: An error occurs when the data exchange is executed.



Device	Name	R/W	Description
			OFF: No error occurs when the data exchange is executed.
SM938	Error flag for data exchange 111	R	ON: An error occurs when the data exchange is executed. OFF: No error occurs when the data exchange is executed.
SM939	Error flag for data exchange 112	R	ON: An error occurs when the data exchange is executed. OFF: No error occurs when the data exchange is executed.
SM940	Error flag for data exchange 113	R	ON: An error occurs when the data exchange is executed. OFF: No error occurs when the data exchange is executed.
SM941	Error flag for data exchange 114	R	ON: An error occurs when the data exchange is executed. OFF: No error occurs when the data exchange is executed.
SM942	Error flag for data exchange 115	R	ON: An error occurs when the data exchange is executed. OFF: No error occurs when the data exchange is executed.
SM943	Error flag for data exchange 116	R	ON: An error occurs when the data exchange is executed. OFF: No error occurs when the data exchange is executed.
SM944	Error flag for data exchange 117	R	ON: An error occurs when the data exchange is executed. OFF: No error occurs when the data exchange is executed.
SM945	Error flag for data exchange 118	R	ON: An error occurs when the data exchange is executed. OFF: No error occurs when the data exchange is executed.
SM946	Error flag for data exchange 119	R	ON: An error occurs when the data exchange is executed. OFF: No error occurs when the data exchange is executed.
SM947	Error flag for data exchange 120	R	ON: An error occurs when the data exchange is executed. OFF: No error occurs when the data exchange is executed.
SM948	Error flag for data exchange 121	R	ON: An error occurs when the data exchange is executed. OFF: No error occurs when the data exchange is executed.
SM949	Error flag for data exchange 122	R	ON: An error occurs when the data exchange is executed. OFF: No error occurs when the data exchange is executed.
SM950	Error flag for data exchange 123	R	ON: An error occurs when the data exchange is executed. OFF: No error occurs when the data exchange is executed.
SM951	Error flag for data exchange 124	R	ON: An error occurs when the data exchange is

Device	Name	R/W	Description
			executed. OFF: No error occurs when the data exchange is executed.
SM952	Error flag for data exchange 125	R	ON: An error occurs when the data exchange is executed. OFF: No error occurs when the data exchange is executed.
SM953	Error flag for data exchange 126	R	ON: An error occurs when the data exchange is executed. OFF: No error occurs when the data exchange is executed.
SM954	Error flag for data exchange 127	R	ON: An error occurs when the data exchange is executed. OFF: No error occurs when the data exchange is executed.
SM955	Error flag for data exchange 128	R	ON: An error occurs when the data exchange is executed. OFF: No error occurs when the data exchange is executed.

◆ AH500 advanced CPU series (AHCPU511/521/531)



Device	Name	R/W	Description
SM700	Enabling the execution of data exchange 1	R/W	ON: Enabling the execution of the data exchange OFF: Disabling the execution of the data exchange
SM701	Enabling the execution of data exchange 2	R/W	ON: Enabling the execution of the data exchange OFF: Disabling the execution of the data exchange
SM702	Enabling the execution of data exchange 3	R/W	ON: Enabling the execution of the data exchange OFF: Disabling the execution of the data exchange
SM703	Enabling the execution of data exchange 4	R/W	ON: Enabling the execution of the data exchange OFF: Disabling the execution of the data exchange
SM704	Enabling the execution of data exchange 5	R/W	ON: Enabling the execution of the data exchange OFF: Disabling the execution of the data exchange
SM705	Enabling the execution of data exchange 6	R/W	ON: Enabling the execution of the data exchange OFF: Disabling the execution of the data exchange
SM706	Enabling the execution of data exchange 7	R/W	ON: Enabling the execution of the data exchange OFF: Disabling the execution of the data exchange
SM707	Enabling the execution of data exchange 8	R/W	ON: Enabling the execution of the data exchange OFF: Disabling the execution of the data exchange
SM708	Enabling the execution of data exchange 9	R/W	ON: Enabling the execution of the data exchange OFF: Disabling the execution of the data exchange
SM709	Enabling the execution of data exchange 10	R/W	ON: Enabling the execution of the data exchange OFF: Disabling the execution of the data exchange
SM710	Enabling the execution of data exchange 11	R/W	ON: Enabling the execution of the data exchange OFF: Disabling the execution of the data exchange
SM711	Enabling the execution of data exchange 12	R/W	ON: Enabling the execution of the data exchange OFF: Disabling the execution of the data exchange
SM712	Enabling the execution of data exchange 13	R/W	ON: Enabling the execution of the data exchange OFF: Disabling the execution of the data exchange
SM713	Enabling the execution of data exchange 14	R/W	ON: Enabling the execution of the data exchange OFF: Disabling the execution of the data exchange
SM714	Enabling the execution of data exchange 15	R/W	ON: Enabling the execution of the data exchange OFF: Disabling the execution of the data exchange
SM715	Enabling the execution of data exchange 16	R/W	ON: Enabling the execution of the data exchange OFF: Disabling the execution of the data exchange
SM716	Enabling the execution of data exchange 17	R/W	ON: Enabling the execution of the data exchange OFF: Disabling the execution of the data exchange
SM717	Enabling the execution of data exchange 18	R/W	ON: Enabling the execution of the data exchange OFF: Disabling the execution of the data

Device	Name	R/W	Description
SM791	Enabling the execution of data exchange 92	R/W	ON: Enabling the execution of the data exchange OFF: Disabling the execution of the data exchange
SM792	Enabling the execution of data exchange 93	R/W	ON: Enabling the execution of the data exchange OFF: Disabling the execution of the data exchange
SM793	Enabling the execution of data exchange 94	R/W	ON: Enabling the execution of the data exchange OFF: Disabling the execution of the data exchange
SM794	Enabling the execution of data exchange 95	R/W	ON: Enabling the execution of the data exchange OFF: Disabling the execution of the data exchange
SM795	Enabling the execution of data exchange 96	R/W	ON: Enabling the execution of the data exchange OFF: Disabling the execution of the data exchange
SM796	Enabling the execution of data exchange 97	R/W	ON: Enabling the execution of the data exchange OFF: Disabling the execution of the data exchange
SM797	Enabling the execution of data exchange 98	R/W	ON: Enabling the execution of the data exchange OFF: Disabling the execution of the data exchange
SM798	Enabling the execution of data exchange 99	R/W	ON: Enabling the execution of the data exchange OFF: Disabling the execution of the data exchange
SM799	Enabling the execution of data exchange 100	R/W	ON: Enabling the execution of the data exchange OFF: Disabling the execution of the data exchange
SM800	Enabling the execution of data exchange 101	R/W	ON: Enabling the execution of the data exchange OFF: Disabling the execution of the data exchange
SM801	Enabling the execution of data exchange 102	R/W	ON: Enabling the execution of the data exchange OFF: Disabling the execution of the data exchange
SM802	Enabling the execution of data exchange 103	R/W	ON: Enabling the execution of the data exchange OFF: Disabling the execution of the data exchange
SM803	Enabling the execution of data exchange 104	R/W	ON: Enabling the execution of the data exchange OFF: Disabling the execution of the data exchange
SM804	Enabling the execution of data exchange 105	R/W	ON: Enabling the execution of the data exchange OFF: Disabling the execution of the data exchange
SM805	Enabling the execution of data exchange 106	R/W	ON: Enabling the execution of the data exchange OFF: Disabling the execution of the data exchange
SM806	Enabling the execution of data exchange 107	R/W	ON: Enabling the execution of the data exchange OFF: Disabling the execution of the data exchange
SM807	Enabling the execution of data exchange 108	R/W	ON: Enabling the execution of the data exchange OFF: Disabling the execution of the data exchange
SM808	Enabling the execution of data exchange 109	R/W	ON: Enabling the execution of the data exchange OFF: Disabling the execution of the data exchange
SM809	Enabling the execution of data	R/W	ON: Enabling the execution of the data exchange

Device	Name	R/W	Description
			exchange
SM828	Error flag for data exchange 1	R/W	ON: An eR/WR/WoR/W occuR/Ws when the data exchange is executed. OFF: No eR/WR/WoR/W occuR/Ws when the data exchange is executed.
SM829	ER/WR/WoR/W flag foR/W data exchange 2	R/W	ON: An eR/WR/WoR/W occuR/Ws when the data exchange is executed. OFF: No eR/WR/WoR/W occuR/Ws when the data exchange is executed.
SM830	ER/WR/WoR/W flag foR/W data exchange 3	R/W	ON: An eR/WR/WoR/W occuR/Ws when the data exchange is executed. OFF: No eR/WR/WoR/W occuR/Ws when the data exchange is executed.
SM831	ER/WR/WoR/W flag foR/W data exchange 4	R/W	ON: An eR/WR/WoR/W occuR/Ws when the data exchange is executed. OFF: No eR/WR/WoR/W occuR/Ws when the data exchange is executed.
SM832	ER/WR/WoR/W flag foR/W data exchange 5	R/W	ON: An eR/WR/WoR/W occuR/Ws when the data exchange is executed. OFF: No eR/WR/WoR/W occuR/Ws when the data exchange is executed.
SM833	ER/WR/WoR/W flag foR/W data exchange 6	R/W	ON: An eR/WR/WoR/W occuR/Ws when the data exchange is executed. OFF: No eR/WR/WoR/W occuR/Ws when the data exchange is executed.
SM834	ER/WR/WoR/W flag foR/W data exchange 7	R/W	ON: An eR/WR/WoR/W occuR/Ws when the data exchange is executed. OFF: No eR/WR/WoR/W occuR/Ws when the data exchange is executed.
SM835	ER/WR/WoR/W flag foR/W data exchange 8	R/W	ON: An eR/WR/WoR/W occuR/Ws when the data exchange is executed. OFF: No eR/WR/WoR/W occuR/Ws when the data exchange is executed.
SM836	ER/WR/WoR/W flag foR/W data exchange 9	R/W	ON: An eR/WR/WoR/W occuR/Ws when the data exchange is executed. OFF: No eR/WR/WoR/W occuR/Ws when the data exchange is executed.
SM837	ER/WR/WoR/W flag foR/W data exchange 10	R/W	ON: An eR/WR/WoR/W occuR/Ws when the data exchange is executed. OFF: No eR/WR/WoR/W occuR/Ws when the data exchange is executed.
SM838	ER/WR/WoR/W flag foR/W data exchange 11	R/W	ON: An eR/WR/WoR/W occuR/Ws when the data exchange is executed. OFF: No eR/WR/WoR/W occuR/Ws when the data exchange is executed.
SM839	ER/WR/WoR/W flag foR/W data exchange 12	R/W	ON: An eR/WR/WoR/W occuR/Ws when the data exchange is executed. OFF: No eR/WR/WoR/W occuR/Ws when the data exchange is executed.
SM840	ER/WR/WoR/W flag foR/W data exchange 13	R/W	ON: An eR/WR/WoR/W occuR/Ws when the data exchange is executed. OFF: No eR/WR/WoR/W occuR/Ws when the data exchange is executed.
SM841	ER/WR/WoR/W flag foR/W data exchange 14	R/W	ON: An eR/WR/WoR/W occuR/Ws when the data exchange is executed.



Device	Name	R/W	Description
			OFF: No eR/WR/WoR/W occuR/Ws when the data exchange is executed.
SM842	ER/WR/WoR/W flag foR/W data exchange 15	R/W	ON: An eR/WR/WoR/W occuR/Ws when the data exchange is executed. OFF: No eR/WR/WoR/W occuR/Ws when the data exchange is executed.
SM843	ER/WR/WoR/W flag foR/W data exchange 16	R/W	ON: An eR/WR/WoR/W occuR/Ws when the data exchange is executed. OFF: No eR/WR/WoR/W occuR/Ws when the data exchange is executed.
SM844	ER/WR/WoR/W flag foR/W data exchange 17	R/W	ON: An eR/WR/WoR/W occuR/Ws when the data exchange is executed. OFF: No eR/WR/WoR/W occuR/Ws when the data exchange is executed.
SM845	ER/WR/WoR/W flag foR/W data exchange 18	R/W	ON: An eR/WR/WoR/W occuR/Ws when the data exchange is executed. OFF: No eR/WR/WoR/W occuR/Ws when the data exchange is executed.
SM846	ER/WR/WoR/W flag foR/W data exchange 19	R/W	ON: An eR/WR/WoR/W occuR/Ws when the data exchange is executed. OFF: No eR/WR/WoR/W occuR/Ws when the data exchange is executed.
SM847	ER/WR/WoR/W flag foR/W data exchange 20	R/W	ON: An eR/WR/WoR/W occuR/Ws when the data exchange is executed. OFF: No eR/WR/WoR/W occuR/Ws when the data exchange is executed.
SM848	ER/WR/WoR/W flag foR/W data exchange 21	R/W	ON: An eR/WR/WoR/W occuR/Ws when the data exchange is executed. OFF: No eR/WR/WoR/W occuR/Ws when the data exchange is executed.
SM849	ER/WR/WoR/W flag foR/W data exchange 22	R/W	ON: An eR/WR/WoR/W occuR/Ws when the data exchange is executed. OFF: No eR/WR/WoR/W occuR/Ws when the data exchange is executed.
SM850	ER/WR/WoR/W flag foR/W data exchange 23	R/W	ON: An eR/WR/WoR/W occuR/Ws when the data exchange is executed. OFF: No eR/WR/WoR/W occuR/Ws when the data exchange is executed.
SM851	ER/WR/WoR/W flag foR/W data exchange 24	R/W	ON: An eR/WR/WoR/W occuR/Ws when the data exchange is executed. OFF: No eR/WR/WoR/W occuR/Ws when the data exchange is executed.
SM852	ER/WR/WoR/W flag foR/W data exchange 25	R/W	ON: An eR/WR/WoR/W occuR/Ws when the data exchange is executed. OFF: No eR/WR/WoR/W occuR/Ws when the data exchange is executed.
SM853	ER/WR/WoR/W flag foR/W data exchange 26	R/W	ON: An eR/WR/WoR/W occuR/Ws when the data exchange is executed. OFF: No eR/WR/WoR/W occuR/Ws when the data exchange is executed.
SM854	ER/WR/WoR/W flag foR/W data exchange 27	R/W	ON: An eR/WR/WoR/W occuR/Ws when the data exchange is executed. OFF: No eR/WR/WoR/W occuR/Ws when the data exchange is executed.
SM855	ER/WR/WoR/W flag foR/W data	R/W	ON: An eR/WR/WoR/W occuR/Ws when the data

Device	Name	R/W	Description
	exchange 28		exchange is executed. OFF: No eR/WR/WoR/W occuR/Ws when the data exchange is executed.
SM856	ER/WR/WoR/W flag foR/W data exchange 29	R/W	ON: An eR/WR/WoR/W occuR/Ws when the data exchange is executed. OFF: No eR/WR/WoR/W occuR/Ws when the data exchange is executed.
SM857	ER/WR/WoR/W flag foR/W data exchange 30	R/W	ON: An eR/WR/WoR/W occuR/Ws when the data exchange is executed. OFF: No eR/WR/WoR/W occuR/Ws when the data exchange is executed.
SM858	ER/WR/WoR/W flag foR/W data exchange 31	R/W	ON: An eR/WR/WoR/W occuR/Ws when the data exchange is executed. OFF: No eR/WR/WoR/W occuR/Ws when the data exchange is executed.
SM859	ER/WR/WoR/W flag foR/W data exchange 32	R/W	ON: An eR/WR/WoR/W occuR/Ws when the data exchange is executed. OFF: No eR/WR/WoR/W occuR/Ws when the data exchange is executed.
SM860	ER/WR/WoR/W flag foR/W data exchange 33	R/W	ON: An eR/WR/WoR/W occuR/Ws when the data exchange is executed. OFF: No eR/WR/WoR/W occuR/Ws when the data exchange is executed.
SM861	ER/WR/WoR/W flag foR/W data exchange 34	R/W	ON: An eR/WR/WoR/W occuR/Ws when the data exchange is executed. OFF: No eR/WR/WoR/W occuR/Ws when the data exchange is executed.
SM862	ER/WR/WoR/W flag foR/W data exchange 35	R/W	ON: An eR/WR/WoR/W occuR/Ws when the data exchange is executed. OFF: No eR/WR/WoR/W occuR/Ws when the data exchange is executed.
SM863	ER/WR/WoR/W flag foR/W data exchange 36	R/W	ON: An eR/WR/WoR/W occuR/Ws when the data exchange is executed. OFF: No eR/WR/WoR/W occuR/Ws when the data exchange is executed.
SM864	ER/WR/WoR/W flag foR/W data exchange 37	R/W	ON: An eR/WR/WoR/W occuR/Ws when the data exchange is executed. OFF: No eR/WR/WoR/W occuR/Ws when the data exchange is executed.
SM865	ER/WR/WoR/W flag foR/W data exchange 38	R/W	ON: An eR/WR/WoR/W occuR/Ws when the data exchange is executed. OFF: No eR/WR/WoR/W occuR/Ws when the data exchange is executed.
SM866	ER/WR/WoR/W flag foR/W data exchange 39	R/W	ON: An eR/WR/WoR/W occuR/Ws when the data exchange is executed. OFF: No eR/WR/WoR/W occuR/Ws when the data exchange is executed.
SM867	ER/WR/WoR/W flag foR/W data exchange 40	R/W	ON: An eR/WR/WoR/W occuR/Ws when the data exchange is executed. OFF: No eR/WR/WoR/W occuR/Ws when the data exchange is executed.
SM868	ER/WR/WoR/W flag foR/W data exchange 41	R/W	ON: An eR/WR/WoR/W occuR/Ws when the data exchange is executed. OFF: No eR/WR/WoR/W occuR/Ws when the data exchange is executed.



Device	Name	R/W	Description
SM869	ER/WR/WoR/W flag foR/W data exchange 42	R/W	ON: An eR/WR/WoR/W occuR/Ws when the data exchange is executed. OFF: No eR/WR/WoR/W occuR/Ws when the data exchange is executed.
SM870	ER/WR/WoR/W flag foR/W data exchange 43	R/W	ON: An eR/WR/WoR/W occuR/Ws when the data exchange is executed. OFF: No eR/WR/WoR/W occuR/Ws when the data exchange is executed.
SM871	ER/WR/WoR/W flag foR/W data exchange 44	R/W	ON: An eR/WR/WoR/W occuR/Ws when the data exchange is executed. OFF: No eR/WR/WoR/W occuR/Ws when the data exchange is executed.
SM872	ER/WR/WoR/W flag foR/W data exchange 45	R/W	ON: An eR/WR/WoR/W occuR/Ws when the data exchange is executed. OFF: No eR/WR/WoR/W occuR/Ws when the data exchange is executed.
SM873	ER/WR/WoR/W flag foR/W data exchange 46	R/W	ON: An eR/WR/WoR/W occuR/Ws when the data exchange is executed. OFF: No eR/WR/WoR/W occuR/Ws when the data exchange is executed.
SM874	ER/WR/WoR/W flag foR/W data exchange 47	R/W	ON: An eR/WR/WoR/W occuR/Ws when the data exchange is executed. OFF: No eR/WR/WoR/W occuR/Ws when the data exchange is executed.
SM875	ER/WR/WoR/W flag foR/W data exchange 48	R/W	ON: An eR/WR/WoR/W occuR/Ws when the data exchange is executed. OFF: No eR/WR/WoR/W occuR/Ws when the data exchange is executed.
SM876	ER/WR/WoR/W flag foR/W data exchange 49	R/W	ON: An eR/WR/WoR/W occuR/Ws when the data exchange is executed. OFF: No eR/WR/WoR/W occuR/Ws when the data exchange is executed.
SM877	ER/WR/WoR/W flag foR/W data exchange 50	R/W	ON: An eR/WR/WoR/W occuR/Ws when the data exchange is executed. OFF: No eR/WR/WoR/W occuR/Ws when the data exchange is executed.
SM878	ER/WR/WoR/W flag foR/W data exchange 51	R/W	ON: An eR/WR/WoR/W occuR/Ws when the data exchange is executed. OFF: No eR/WR/WoR/W occuR/Ws when the data exchange is executed.
SM879	ER/WR/WoR/W flag foR/W data exchange 52	R/W	ON: An eR/WR/WoR/W occuR/Ws when the data exchange is executed. OFF: No eR/WR/WoR/W occuR/Ws when the data exchange is executed.
SM880	ER/WR/WoR/W flag foR/W data exchange 53	R/W	ON: An eR/WR/WoR/W occuR/Ws when the data exchange is executed. OFF: No eR/WR/WoR/W occuR/Ws when the data exchange is executed.
SM881	ER/WR/WoR/W flag foR/W data exchange 54	R/W	ON: An eR/WR/WoR/W occuR/Ws when the data exchange is executed. OFF: No eR/WR/WoR/W occuR/Ws when the data exchange is executed.
SM882	ER/WR/WoR/W flag foR/W data exchange 55	R/W	ON: An eR/WR/WoR/W occuR/Ws when the data exchange is executed. OFF: No eR/WR/WoR/W occuR/Ws when the

Device	Name	R/W	Description
			data exchange is executed.
SM883	ER/WR/WoR/W flag foR/W data exchange 56	R/W	ON: An eR/WR/WoR/W occuR/Ws when the data exchange is executed. OFF: No eR/WR/WoR/W occuR/Ws when the data exchange is executed.
SM884	ER/WR/WoR/W flag foR/W data exchange 57	R/W	ON: An eR/WR/WoR/W occuR/Ws when the data exchange is executed. OFF: No eR/WR/WoR/W occuR/Ws when the data exchange is executed.
SM885	ER/WR/WoR/W flag foR/W data exchange 58	R/W	ON: An eR/WR/WoR/W occuR/Ws when the data exchange is executed. OFF: No eR/WR/WoR/W occuR/Ws when the data exchange is executed.
SM886	ER/WR/WoR/W flag foR/W data exchange 59	R/W	ON: An eR/WR/WoR/W occuR/Ws when the data exchange is executed. OFF: No eR/WR/WoR/W occuR/Ws when the data exchange is executed.
SM887	ER/WR/WoR/W flag foR/W data exchange 60	R/W	ON: An eR/WR/WoR/W occuR/Ws when the data exchange is executed. OFF: No eR/WR/WoR/W occuR/Ws when the data exchange is executed.
SM888	ER/WR/WoR/W flag foR/W data exchange 61	R/W	ON: An eR/WR/WoR/W occuR/Ws when the data exchange is executed. OFF: No eR/WR/WoR/W occuR/Ws when the data exchange is executed.
SM889	ER/WR/WoR/W flag foR/W data exchange 62	R/W	ON: An eR/WR/WoR/W occuR/Ws when the data exchange is executed. OFF: No eR/WR/WoR/W occuR/Ws when the data exchange is executed.
SM890	ER/WR/WoR/W flag foR/W data exchange 63	R/W	ON: An eR/WR/WoR/W occuR/Ws when the data exchange is executed. OFF: No eR/WR/WoR/W occuR/Ws when the data exchange is executed.
SM891	ER/WR/WoR/W flag foR/W data exchange 64	R/W	ON: An eR/WR/WoR/W occuR/Ws when the data exchange is executed. OFF: No eR/WR/WoR/W occuR/Ws when the data exchange is executed.
SM892	ER/WR/WoR/W flag foR/W data exchange 65	R/W	ON: An eR/WR/WoR/W occuR/Ws when the data exchange is executed. OFF: No eR/WR/WoR/W occuR/Ws when the data exchange is executed.
SM893	ER/WR/WoR/W flag foR/W data exchange 66	R/W	ON: An eR/WR/WoR/W occuR/Ws when the data exchange is executed. OFF: No eR/WR/WoR/W occuR/Ws when the data exchange is executed.
SM894	ER/WR/WoR/W flag foR/W data exchange 67	R/W	ON: An eR/WR/WoR/W occuR/Ws when the data exchange is executed. OFF: No eR/WR/WoR/W occuR/Ws when the data exchange is executed.
SM895	ER/WR/WoR/W flag foR/W data exchange 68	R/W	ON: An eR/WR/WoR/W occuR/Ws when the data exchange is executed. OFF: No eR/WR/WoR/W occuR/Ws when the data exchange is executed.
SM896	ER/WR/WoR/W flag foR/W data exchange 69	R/W	ON: An eR/WR/WoR/W occuR/Ws when the data exchange is executed.



Device	Name	R/W	Description
			OFF: No eR/WR/WoR/W occuR/Ws when the data exchange is executed.
SM897	ER/WR/WoR/W flag foR/W data exchange 70	R/W	ON: An eR/WR/WoR/W occuR/Ws when the data exchange is executed. OFF: No eR/WR/WoR/W occuR/Ws when the data exchange is executed.
SM898	ER/WR/WoR/W flag foR/W data exchange 71	R/W	ON: An eR/WR/WoR/W occuR/Ws when the data exchange is executed. OFF: No eR/WR/WoR/W occuR/Ws when the data exchange is executed.
SM899	ER/WR/WoR/W flag foR/W data exchange 72	R/W	ON: An eR/WR/WoR/W occuR/Ws when the data exchange is executed. OFF: No eR/WR/WoR/W occuR/Ws when the data exchange is executed.
SM900	ER/WR/WoR/W flag foR/W data exchange 73	R/W	ON: An eR/WR/WoR/W occuR/Ws when the data exchange is executed. OFF: No eR/WR/WoR/W occuR/Ws when the data exchange is executed.
SM901	ER/WR/WoR/W flag foR/W data exchange 74	R/W	ON: An eR/WR/WoR/W occuR/Ws when the data exchange is executed. OFF: No eR/WR/WoR/W occuR/Ws when the data exchange is executed.
SM902	ER/WR/WoR/W flag foR/W data exchange 75	R/W	ON: An eR/WR/WoR/W occuR/Ws when the data exchange is executed. OFF: No eR/WR/WoR/W occuR/Ws when the data exchange is executed.
SM903	ER/WR/WoR/W flag foR/W data exchange 76	R/W	ON: An eR/WR/WoR/W occuR/Ws when the data exchange is executed. OFF: No eR/WR/WoR/W occuR/Ws when the data exchange is executed.
SM904	ER/WR/WoR/W flag foR/W data exchange 77	R/W	ON: An eR/WR/WoR/W occuR/Ws when the data exchange is executed. OFF: No eR/WR/WoR/W occuR/Ws when the data exchange is executed.
SM905	ER/WR/WoR/W flag foR/W data exchange 78	R/W	ON: An eR/WR/WoR/W occuR/Ws when the data exchange is executed. OFF: No eR/WR/WoR/W occuR/Ws when the data exchange is executed.
SM906	ER/WR/WoR/W flag foR/W data exchange 79	R/W	ON: An eR/WR/WoR/W occuR/Ws when the data exchange is executed. OFF: No eR/WR/WoR/W occuR/Ws when the data exchange is executed.
SM907	ER/WR/WoR/W flag foR/W data exchange 80	R/W	ON: An eR/WR/WoR/W occuR/Ws when the data exchange is executed. OFF: No eR/WR/WoR/W occuR/Ws when the data exchange is executed.
SM908	ER/WR/WoR/W flag foR/W data exchange 81	R/W	ON: An eR/WR/WoR/W occuR/Ws when the data exchange is executed. OFF: No eR/WR/WoR/W occuR/Ws when the data exchange is executed.
SM909	ER/WR/WoR/W flag foR/W data exchange 82	R/W	ON: An eR/WR/WoR/W occuR/Ws when the data exchange is executed. OFF: No eR/WR/WoR/W occuR/Ws when the data exchange is executed.
SM910	ER/WR/WoR/W flag foR/W data	R/W	ON: An eR/WR/WoR/W occuR/Ws when the data

Device	Name	R/W	Description
	exchange 83		exchange is executed. OFF: No eR/WR/WoR/W occuR/Ws when the data exchange is executed.
SM911	ER/WR/WoR/W flag foR/W data exchange 84	R/W	ON: An eR/WR/WoR/W occuR/Ws when the data exchange is executed. OFF: No eR/WR/WoR/W occuR/Ws when the data exchange is executed.
SM912	ER/WR/WoR/W flag foR/W data exchange 85	R/W	ON: An eR/WR/WoR/W occuR/Ws when the data exchange is executed. OFF: No eR/WR/WoR/W occuR/Ws when the data exchange is executed.
SM913	ER/WR/WoR/W flag foR/W data exchange 86	R/W	ON: An eR/WR/WoR/W occuR/Ws when the data exchange is executed. OFF: No eR/WR/WoR/W occuR/Ws when the data exchange is executed.
SM914	ER/WR/WoR/W flag foR/W data exchange 87	R/W	ON: An eR/WR/WoR/W occuR/Ws when the data exchange is executed. OFF: No eR/WR/WoR/W occuR/Ws when the data exchange is executed.
SM915	ER/WR/WoR/W flag foR/W data exchange 88	R/W	ON: An eR/WR/WoR/W occuR/Ws when the data exchange is executed. OFF: No eR/WR/WoR/W occuR/Ws when the data exchange is executed.
SM916	ER/WR/WoR/W flag foR/W data exchange 89	R/W	ON: An eR/WR/WoR/W occuR/Ws when the data exchange is executed. OFF: No eR/WR/WoR/W occuR/Ws when the data exchange is executed.
SM917	ER/WR/WoR/W flag foR/W data exchange 90	R/W	ON: An eR/WR/WoR/W occuR/Ws when the data exchange is executed. OFF: No eR/WR/WoR/W occuR/Ws when the data exchange is executed.
SM918	ER/WR/WoR/W flag foR/W data exchange 91	R/W	ON: An eR/WR/WoR/W occuR/Ws when the data exchange is executed. OFF: No eR/WR/WoR/W occuR/Ws when the data exchange is executed.
SM919	ER/WR/WoR/W flag foR/W data exchange 92	R/W	ON: An eR/WR/WoR/W occuR/Ws when the data exchange is executed. OFF: No eR/WR/WoR/W occuR/Ws when the data exchange is executed.
SM920	ER/WR/WoR/W flag foR/W data exchange 93	R/W	ON: An eR/WR/WoR/W occuR/Ws when the data exchange is executed. OFF: No eR/WR/WoR/W occuR/Ws when the data exchange is executed.
SM921	ER/WR/WoR/W flag foR/W data exchange 94	R/W	ON: An eR/WR/WoR/W occuR/Ws when the data exchange is executed. OFF: No eR/WR/WoR/W occuR/Ws when the data exchange is executed.
SM922	ER/WR/WoR/W flag foR/W data exchange 95	R/W	ON: An eR/WR/WoR/W occuR/Ws when the data exchange is executed. OFF: No eR/WR/WoR/W occuR/Ws when the data exchange is executed.
SM923	ER/WR/WoR/W flag foR/W data exchange 96	R/W	ON: An eR/WR/WoR/W occuR/Ws when the data exchange is executed. OFF: No eR/WR/WoR/W occuR/Ws when the data exchange is executed.



Device	Name	R/W	Description
SM924	ER/WR/WoR/W flag foR/W data exchange 97	R/W	ON: An eR/WR/WoR/W occuR/Ws when the data exchange is executed. OFF: No eR/WR/WoR/W occuR/Ws when the data exchange is executed.
SM925	ER/WR/WoR/W flag foR/W data exchange 98	R/W	ON: An eR/WR/WoR/W occuR/Ws when the data exchange is executed. OFF: No eR/WR/WoR/W occuR/Ws when the data exchange is executed.
SM926	ER/WR/WoR/W flag foR/W data exchange 99	R/W	ON: An eR/WR/WoR/W occuR/Ws when the data exchange is executed. OFF: No eR/WR/WoR/W occuR/Ws when the data exchange is executed.
SM927	ER/WR/WoR/W flag foR/W data exchange 100	R/W	ON: An eR/WR/WoR/W occuR/Ws when the data exchange is executed. OFF: No eR/WR/WoR/W occuR/Ws when the data exchange is executed.
SM928	ER/WR/WoR/W flag foR/W data exchange 101	R/W	ON: An eR/WR/WoR/W occuR/Ws when the data exchange is executed. OFF: No eR/WR/WoR/W occuR/Ws when the data exchange is executed.
SM929	ER/WR/WoR/W flag foR/W data exchange 102	R/W	ON: An eR/WR/WoR/W occuR/Ws when the data exchange is executed. OFF: No eR/WR/WoR/W occuR/Ws when the data exchange is executed.
SM930	ER/WR/WoR/W flag foR/W data exchange 103	R/W	ON: An eR/WR/WoR/W occuR/Ws when the data exchange is executed. OFF: No eR/WR/WoR/W occuR/Ws when the data exchange is executed.
SM931	ER/WR/WoR/W flag foR/W data exchange 104	R/W	ON: An eR/WR/WoR/W occuR/Ws when the data exchange is executed. OFF: No eR/WR/WoR/W occuR/Ws when the data exchange is executed.
SM932	ER/WR/WoR/W flag foR/W data exchange 105	R/W	ON: An eR/WR/WoR/W occuR/Ws when the data exchange is executed. OFF: No eR/WR/WoR/W occuR/Ws when the data exchange is executed.
SM933	ER/WR/WoR/W flag foR/W data exchange 106	R/W	ON: An eR/WR/WoR/W occuR/Ws when the data exchange is executed. OFF: No eR/WR/WoR/W occuR/Ws when the data exchange is executed.
SM934	ER/WR/WoR/W flag foR/W data exchange 107	R/W	ON: An eR/WR/WoR/W occuR/Ws when the data exchange is executed. OFF: No eR/WR/WoR/W occuR/Ws when the data exchange is executed.
SM935	ER/WR/WoR/W flag foR/W data exchange 108	R/W	ON: An eR/WR/WoR/W occuR/Ws when the data exchange is executed. OFF: No eR/WR/WoR/W occuR/Ws when the data exchange is executed.
SM936	ER/WR/WoR/W flag foR/W data exchange 109	R/W	ON: An eR/WR/WoR/W occuR/Ws when the data exchange is executed. OFF: No eR/WR/WoR/W occuR/Ws when the data exchange is executed.
SM937	ER/WR/WoR/W flag foR/W data exchange 110	R/W	ON: An eR/WR/WoR/W occuR/Ws when the data exchange is executed. OFF: No eR/WR/WoR/W occuR/Ws when the

Device	Name	R/W	Description
			data exchange is executed.
SM938	ER/WR/WoR/W flag foR/W data exchange 111	R/W	ON: An eR/WR/WoR/W occuR/Ws when the data exchange is executed. OFF: No eR/WR/WoR/W occuR/Ws when the data exchange is executed.
SM939	ER/WR/WoR/W flag foR/W data exchange 112	R/W	ON: An eR/WR/WoR/W occuR/Ws when the data exchange is executed. OFF: No eR/WR/WoR/W occuR/Ws when the data exchange is executed.
SM940	ER/WR/WoR/W flag foR/W data exchange 113	R/W	ON: An eR/WR/WoR/W occuR/Ws when the data exchange is executed. OFF: No eR/WR/WoR/W occuR/Ws when the data exchange is executed.
SM941	ER/WR/WoR/W flag foR/W data exchange 114	R/W	ON: An eR/WR/WoR/W occuR/Ws when the data exchange is executed. OFF: No eR/WR/WoR/W occuR/Ws when the data exchange is executed.
SM942	ER/WR/WoR/W flag foR/W data exchange 115	R/W	ON: An eR/WR/WoR/W occuR/Ws when the data exchange is executed. OFF: No eR/WR/WoR/W occuR/Ws when the data exchange is executed.
SM943	ER/WR/WoR/W flag foR/W data exchange 116	R/W	ON: An eR/WR/WoR/W occuR/Ws when the data exchange is executed. OFF: No eR/WR/WoR/W occuR/Ws when the data exchange is executed.
SM944	ER/WR/WoR/W flag foR/W data exchange 117	R/W	ON: An eR/WR/WoR/W occuR/Ws when the data exchange is executed. OFF: No eR/WR/WoR/W occuR/Ws when the data exchange is executed.
SM945	ER/WR/WoR/W flag foR/W data exchange 118	R/W	ON: An eR/WR/WoR/W occuR/Ws when the data exchange is executed. OFF: No eR/WR/WoR/W occuR/Ws when the data exchange is executed.
SM946	ER/WR/WoR/W flag foR/W data exchange 119	R/W	ON: An eR/WR/WoR/W occuR/Ws when the data exchange is executed. OFF: No eR/WR/WoR/W occuR/Ws when the data exchange is executed.
SM947	ER/WR/WoR/W flag foR/W data exchange 120	R/W	ON: An eR/WR/WoR/W occuR/Ws when the data exchange is executed. OFF: No eR/WR/WoR/W occuR/Ws when the data exchange is executed.
SM948	ER/WR/WoR/W flag foR/W data exchange 121	R/W	ON: An eR/WR/WoR/W occuR/Ws when the data exchange is executed. OFF: No eR/WR/WoR/W occuR/Ws when the data exchange is executed.
SM949	ER/WR/WoR/W flag foR/W data exchange 122	R/W	ON: An eR/WR/WoR/W occuR/Ws when the data exchange is executed. OFF: No eR/WR/WoR/W occuR/Ws when the data exchange is executed.
SM950	ER/WR/WoR/W flag foR/W data exchange 123	R/W	ON: An eR/WR/WoR/W occuR/Ws when the data exchange is executed. OFF: No eR/WR/WoR/W occuR/Ws when the data exchange is executed.
SM951	ER/WR/WoR/W flag foR/W data exchange 124	R/W	ON: An eR/WR/WoR/W occuR/Ws when the data exchange is executed.

Device	Name	R/W	Description
			OFF: No eR/WR/WoR/W occuR/Ws when the data exchange is executed.
SM952	ER/WR/WoR/W flag foR/W data exchange 125	R/W	ON: An eR/WR/WoR/W occuR/Ws when the data exchange is executed. OFF: No eR/WR/WoR/W occuR/Ws when the data exchange is executed.
SM953	ER/WR/WoR/W flag foR/W data exchange 126	R/W	ON: An eR/WR/WoR/W occuR/Ws when the data exchange is executed. OFF: No eR/WR/WoR/W occuR/Ws when the data exchange is executed.
SM954	ER/WR/WoR/W flag foR/W data exchange 127	R/W	ON: An eR/WR/WoR/W occuR/Ws when the data exchange is executed. OFF: No eR/WR/WoR/W occuR/Ws when the data exchange is executed.
SM955	ER/WR/WoR/W flag foR/W data exchange 128	R/W	ON: An eR/WR/WoR/W occuR/Ws when the data exchange is executed. OFF: No eR/WR/WoR/W occuR/Ws when the data exchange is executed.

11.4 Web

11.4.1 Introduction

AHCPU5XX-EN is equipped with a web monitoring function. Users can view information (such as the I/O table, devices, system logs, setting values) in AHCPU5XX-EN by means of a web browser, e.g. Internet Explorer.

11.4.2 Usage

1. Start ISPSOFT, and then double-click **HWCONFIG** in the project management area. Double-click the CPU module in the system configuration area. Click the **Ethernet-Advance** tab at the top of the **PLC Parameter Setting** window, and the **Web** tab at the bottom of the **PLC Parameter Setting** window. Select the **Enable Web Function** checkbox.
 2. Select a language which will be adopted in the drop-down list box in the **PLC Parameter Setting** window.
- ◆ **AH500 basic CPU series (AHCPU500/510/520/530-EN)**

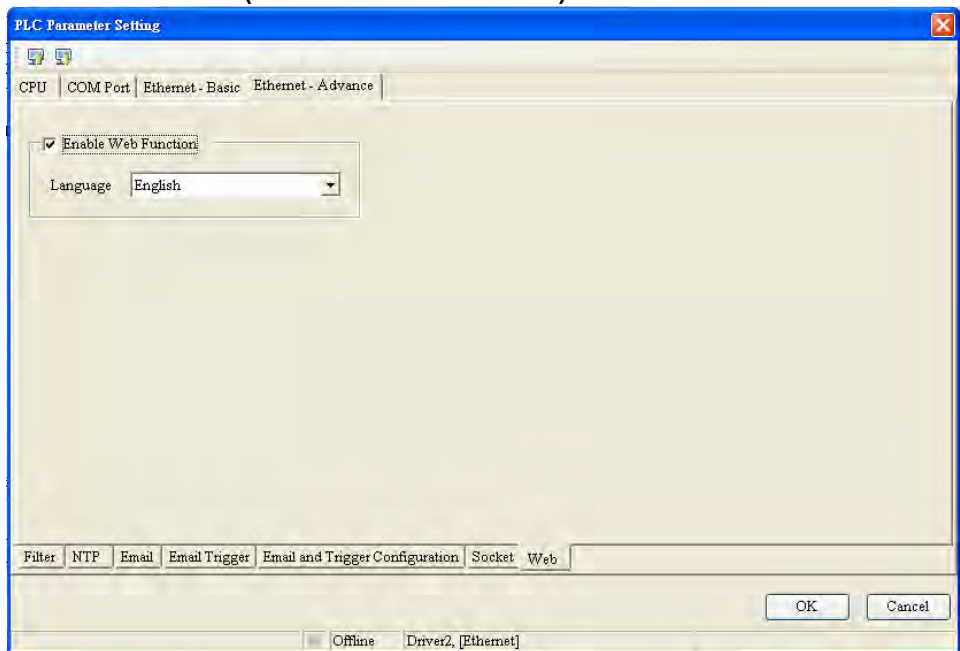

◆ **AH500 advanced CPU series (AHCPU511/521/531-EN)**

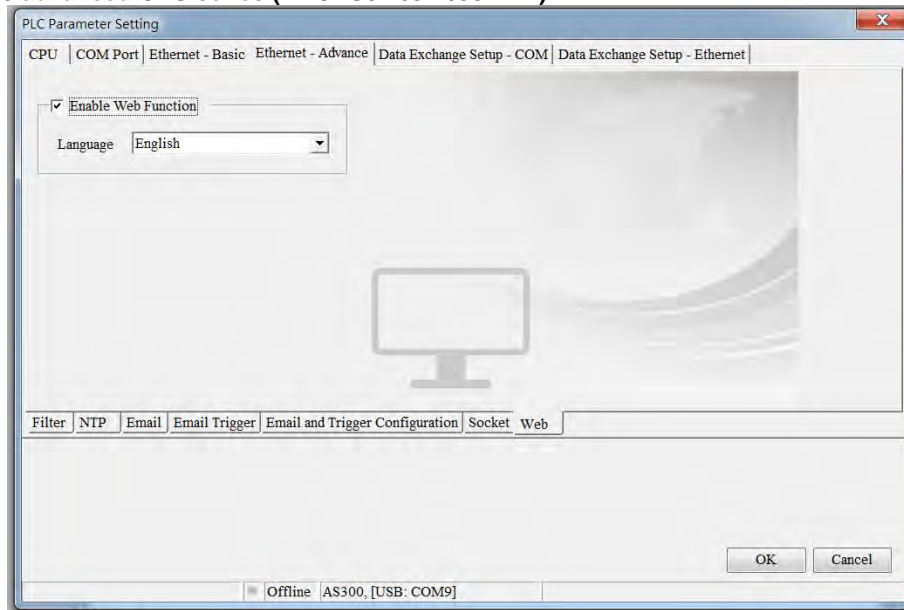

3. Click  in the upper left corner of the **PLC Parameter Setting** window. Select the **Ethernet—Advance** checkbox in the **Transfer Setup** window, and then click **OK**.

◆ **AH500 basic CPU series (AHCPU500/510/520/530-EN)**



◆ **AH500 advanced CPU series (AHCPU511/521/531-EN)**

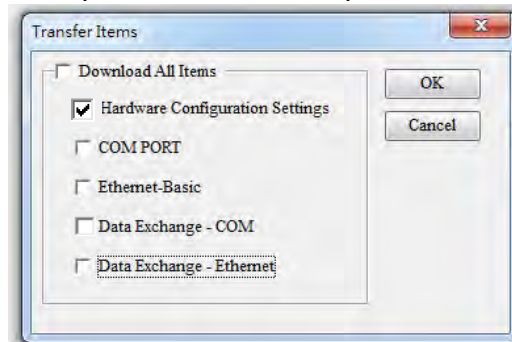

4. After the parameters are downloaded, the web monitoring function can be used.

5. Open Internet Explorer, type the IP address which is set in the address bar, and press Enter on the keyboard.

11

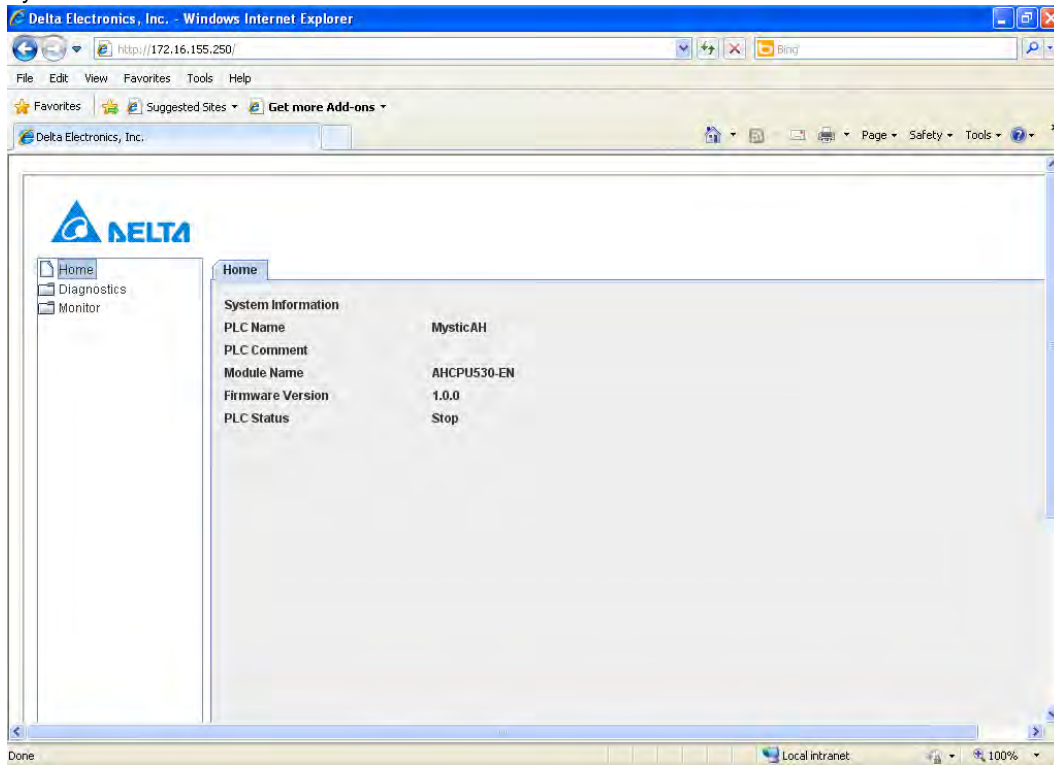

11.4.3 Troubleshooting

- Unable to connect to a CPU module
 1. Please make sure that Java has been installed correctly. Users can check whether Java has been installed correctly by visiting the Java webpage.
 2. Please check the setting related to a proxy server. If there is setting related to a proxy server, users have to disable the proxy server, or make an exception.
- Disabling a proxy server
 1. Launch Internet Explorer, click the **Tools** menu, and click **Internet Options**.
 2. Click the **Connections** tab, and click **LAN settings**.



3. Unselect the **Use a proxy server for your LAN (These settings will not apply to dial-up or VPN connections)**. checkbox, and click **OK**.

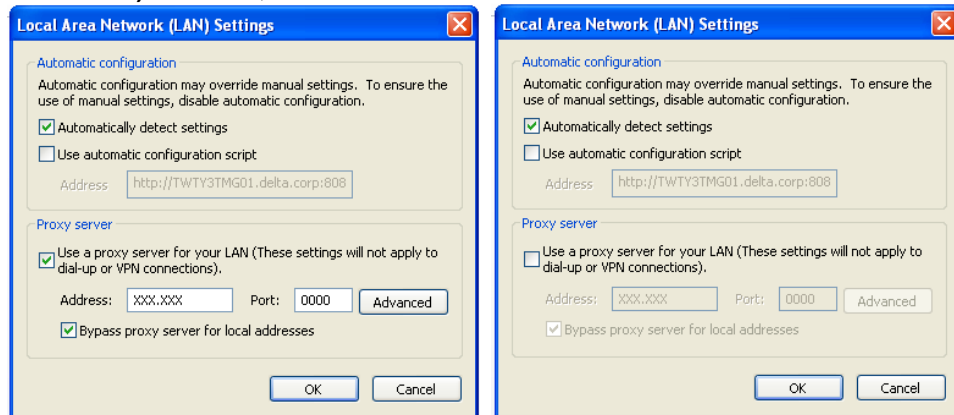

- Making an exception

1. Click **Advanced** in the **Local Area Network (LAN) Settings** window.

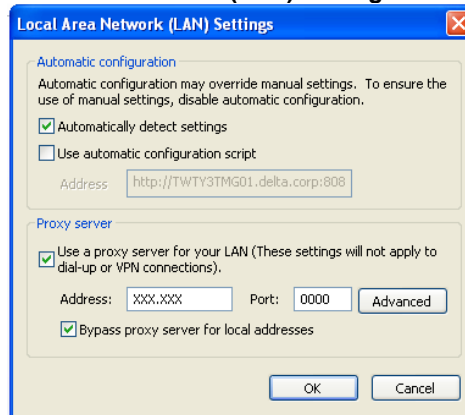

2. Type the IP address assigned to the AH500 series CPU module which is used in the **Do not use proxy server for addresses beginning with:** box.

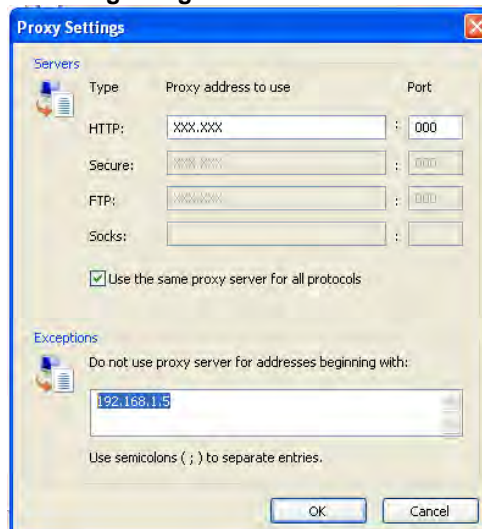

3. Click **OK**.

- If webpages can not be displayed normally, users have to delete temporary Internet files.
 1. Launch Internet Explorer, click the **Tools** menu, and click **Internet Options**.

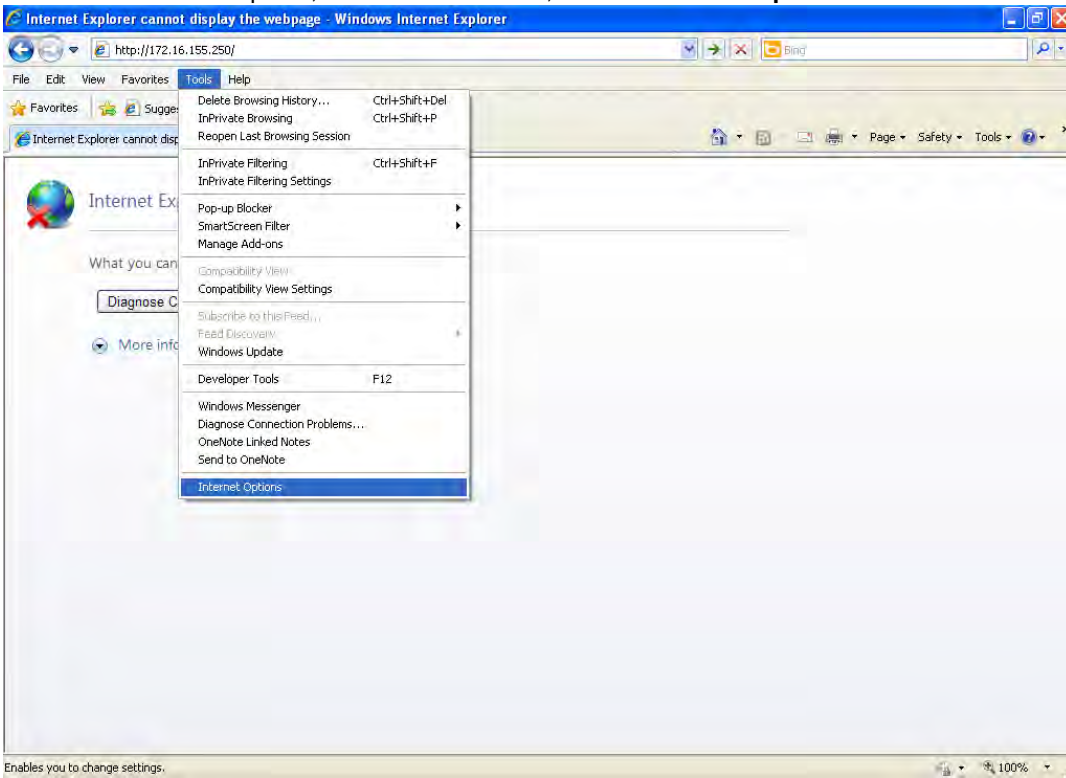

2. Click the **General** tab, and click **Delete...**

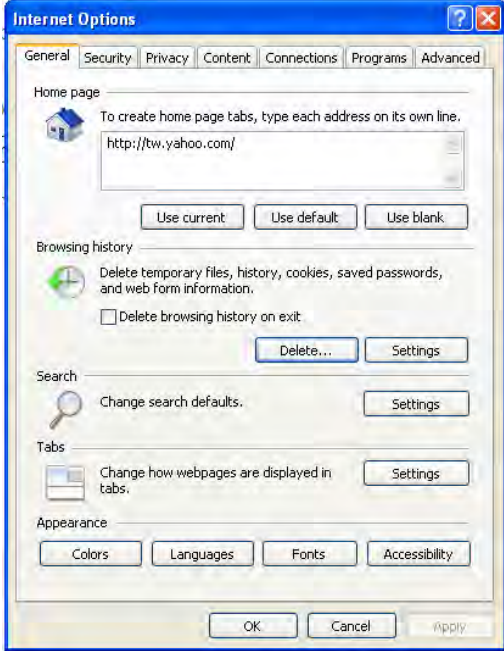

3. Select the **Temporary Internet files** checkbox, and click **Delete**.

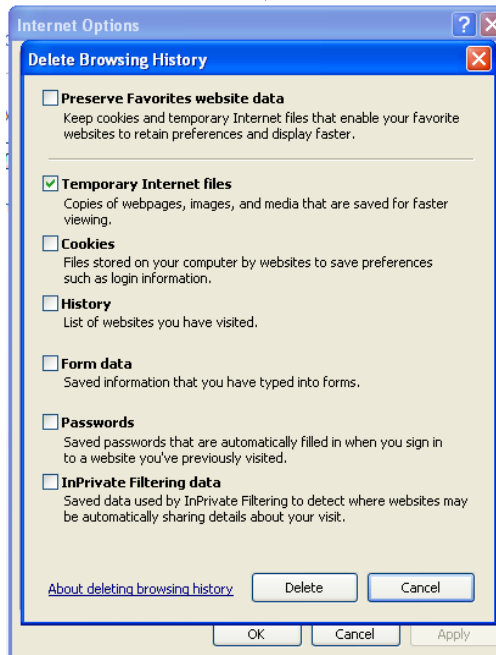

4. Click **OK**.

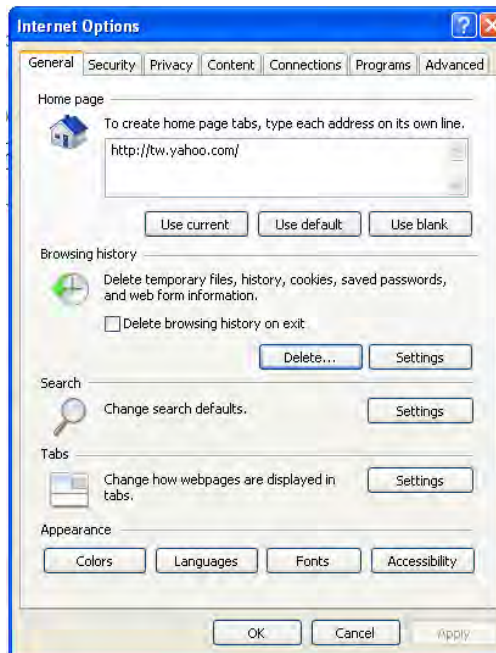

11.5 EtherNet/IP

Please refer to EtherNet/IP user manual for more information.

MEMO

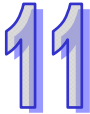

Chapter 12 Troubleshooting

Table of Contents

12.1	Troubleshooting	12-2
12.1.1	Basic Inspection	12-2
12.1.2	Eliminating Errors	12-2
12.1.3	Troubleshooting Procedure	12-3
12.1.4	Viewing Error Logs	12-4
12.2	Troubleshooting for CPU Modules	12-5
12.2.1	ERROR LED Indicator's Being ON	12-5
12.2.2	ERROR LED Indicator's Blinking	12-6
12.2.3	BUS FAULT LED Indicator's Being ON	12-11
12.2.4	BUS FAULT LED Indicator's Blinking	12-12
12.2.5	Troubleshooting for EtherNet/IP	12-13
12.2.6	Others	12-14
12.3	Troubleshooting for I/O Modules	12-29
12.3.1	Troubleshooting for Analog I/O Modules and Temperature Measurement Modules	12-30
12.3.2	Troubleshooting for AH02HC-5A/AH04HC-5A	12-32
12.3.3	Troubleshooting for AH05PM-5A/AH10PM-5A/AH15PM-5A	12-34
12.3.4	Troubleshooting for AH20MC-5A	12-35
12.3.5	Troubleshooting for AH10EN-5A	12-36
12.3.6	Troubleshooting for AH10SCM-5A	12-37
12.3.7	Troubleshooting for AH10DNET-5A	12-37
12.3.8	Troubleshooting for AH10PFBM-5A	12-38
12.3.9	Troubleshooting for AH10PFBS-5A	12-39
12.3.10	Troubleshooting for AH10COPM-5A	12-39
12.4	Error Codes and LED Indicators	12-41
12.4.1	CPU Modules	12-41
12.4.2	Analog I/O Modules and Temperature Measurement Modules	12-55
12.4.3	AH02HC-5A/AH04HC-5A	12-56
12.4.4	AH05PM-5A/AH10PM-5A/AH15PM-5A	12-56
12.4.5	AH20MC-5A	12-57
12.4.6	AH10EN-5A	12-58
12.4.7	AH10SCM-5A/AH15SCM-5A	12-59
12.4.8	AH10DNET-5A	12-59
12.4.9	AH10PFBM-5A	12-60
12.4.10	AH10PFBS-5A	12-60
12.4.11	AH10COPM-5A	12-61

12.1 Troubleshooting

12.1.1 Basic Inspection

This chapter describes errors which occur when a system operates, reasons for these errors, and remedies. Before eliminating an error, users have to determine the reason for the error. Before determining the reason, the users have to check the following.

- 
- (1) The following items have to be checked.
 - The PLC system must operate under the conditions which are regulated, e.g. the environment, the electrical condition, the mechanical vibration, and etc.
 - The power is supplied to the power supply module properly, and the power supplied to the PLC system is normal.
 - The backplanes, modules, terminals, and cables are installed properly.
 - Every LED indicator is in a normal state.
 - The setting of the switches is correct.
 - (2) Follow the instructions below, and check the operating state of the AH500 system.
 - Turn the RUN/STOP switch.
 - Check the condition for the running/stopping of the CPU module.
 - Check and eliminate the influences that the external devices may cause.
 - Monitor the operating state of the system and the error logs by means of ISPSOft.
 - (3) Determine the reason for the error according to (1) and (2) above.
 - The AH500 system or the external devices
 - The CPU module or the extension modules
 - The parameters or the control programs

12.1.2 Eliminating Errors

If an error occurs in a system, users can try to eliminate the error in the following ways. If the reason for the error still exists after the error is eliminate, the error will occur in the system again.

- (1) Stop the CPU module, and then run it.
- (2) Disconnect the CPU module, and then connect it.
- (3) Clear the error log by means of ISPSOft.
- (4) After the CPU module is rest, or restored to the factory setting, download the program again, and execute the program.

12.1.3 Troubleshooting Procedure

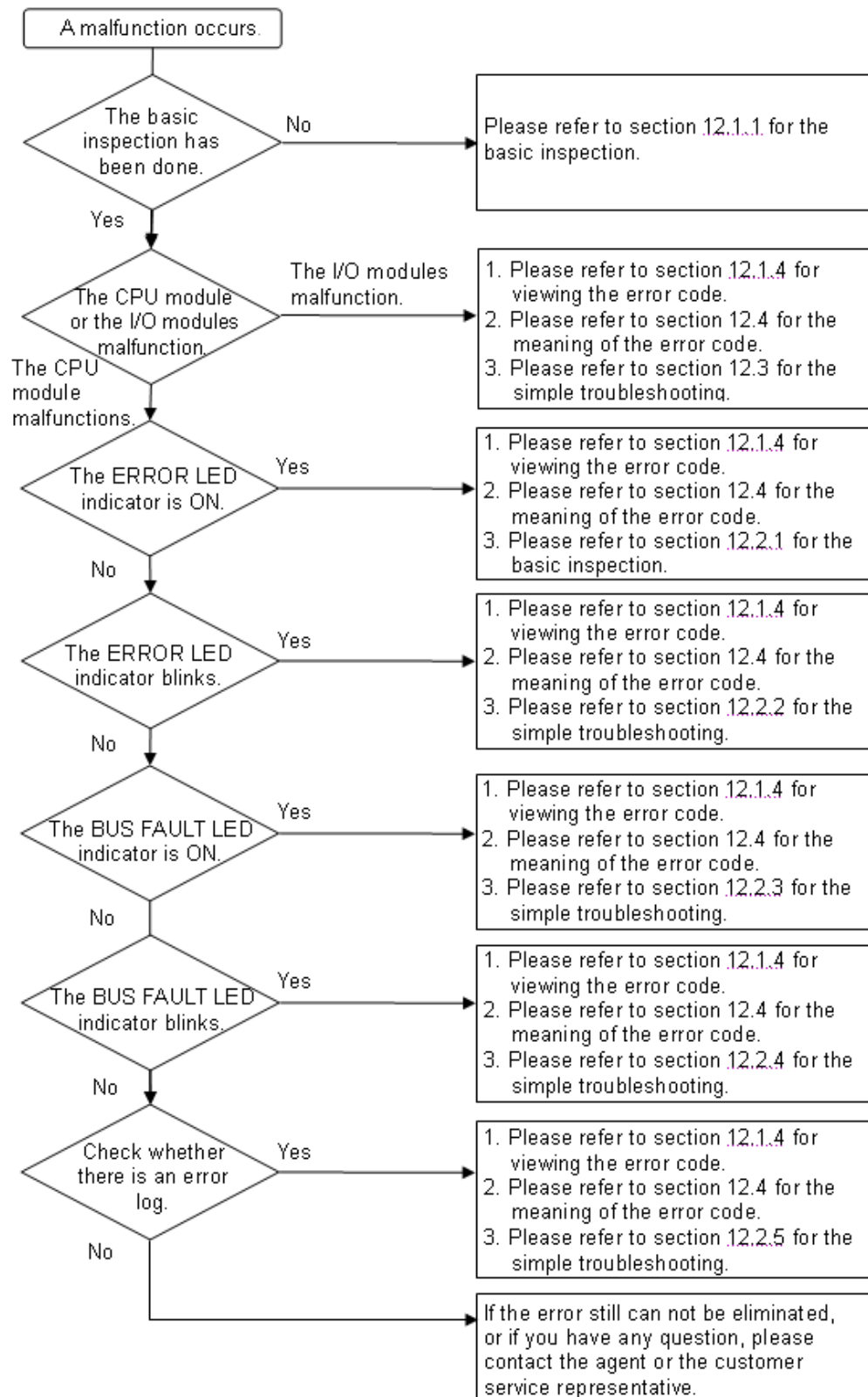

12.1.4 Viewing Error Logs

When an error occurs, a corresponding error code generated by a system is recorded in a CPU module. Twenty error logs at most can be stored in the CPU module. If there are more than twenty error logs generated, the oldest error log will be overwritten by the latest error log. However, if a memory card is installed in the CPU module, the twenty error logs are automatically backed up in the memory card before the oldest error log is overwritten. One thousand error logs at most can be stored in the memory card. If there are more than 1000 error logs which will be stored in the memory card, the twenty oldest error logs will be overwritten by the twenty latest error logs.

(1) After ISPSOft is started, click **System Log** on the **PLC** menu.

12

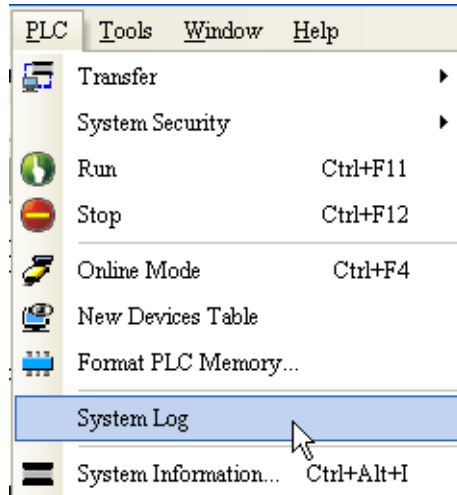

(2) The **System Log** window is as follows. Users can refresh the error logs by clicking **Refresh**, and clear the error logs in the window and the CPU module by clicking **Clear**.

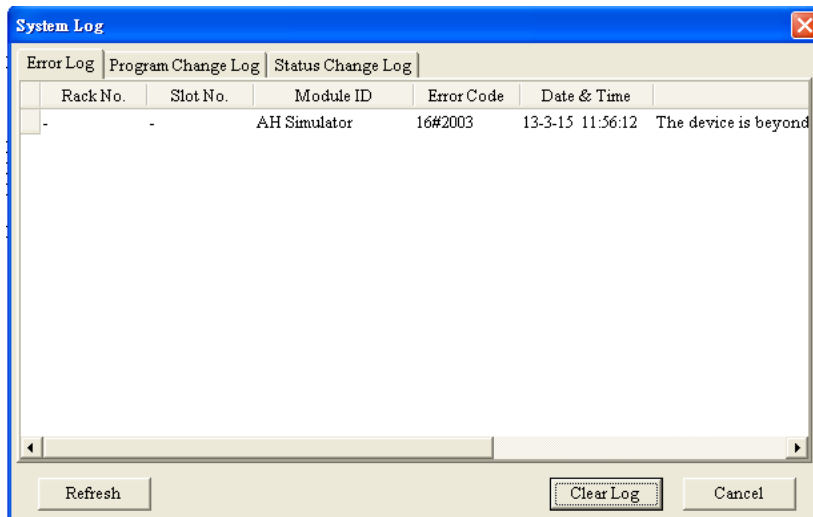

- Rack number & Slot number: If errors are generated by extension modules, the racks and the slots on which the extension modules are installed are recorded in these columns. If no rack number and no slot number are recorded, it means that an error occurs in a CPU module.
- Module ID: The IDs of CPU modules, or those of extension modules
- Error Code: The error codes for error logs
- Date & Time: The time when errors occur
- The newer error log is exhibited in the upper row.
- The description related to an error log is in the last field.

12.2 Troubleshooting for CPU Modules

Users can get the remedies from the tables below according to the statuses of the LED indicators and the error codes.

12.2.1 ERROR LED Indicator's Being ON

Error code	Description	Remedy
16#000B	The program in the PLC is damaged.	Download the program again.
16#000D	The CPU parameters are damaged.	Reset the CPU parameter, and download it.
16#0010	The access to the memory in the CPU is denied.	Download the program or parameters again. If the problem still occurs, please contact the factory.
16#0011	The PLC ID is incorrect. (SM9)	Please check the PLC ID.
16#0012	The PLC password is incorrect. (SM9)	Please check the PLC password.
16#0014	The procedure of restoring the system can not be executed. (SM9)	The contents of the system backup file are incorrect, or the file does not exist in the path specified. If the file exists and the procedure of restoring the system can not be executed, please backing up the system again. If the error still occurs, please contact the factory. (Please refer to section 7.5 in AH500 Operation Manual, and section 18.2 in ISPSOFT User Manual for more information about the memory card.)
16#0015	The module table is incorrect. (SM10)	The module table stored in the CPU module is incorrect. Compare the module table in HWCONFIG with the actual module configuration, and download the module table again.
16#0016	The module setting is incorrect. (SM10)	The module setting stored in the CPU module is incorrect. Check whether the version of the module inserted in the slot is the same as the version of the module in HWCONFIG. After the version of the module is updated, users can download the module setting again.
16#0017	The data register exceeds the device range. (SM10)	The data register stored in the CPU module exceeds the device range. Check whether the module parameter in HWCONFIG is correct, and download the module parameter again.
16#001B	Timed interrupt 0 is set incorrectly.	Set the CPU parameter in HWCONFIG again, and download the CPU parameter again.
16#001C	Timed interrupt 1 is set incorrectly.	Set the CPU parameter in HWCONFIG again, and download the CPU parameter again.
16#001D	Timed interrupt 2 is set incorrectly.	Set the CPU parameter in HWCONFIG again, and download the CPU parameter again.
16#001E	Timed interrupt 3 is set incorrectly.	Set the CPU parameter in HWCONFIG again, and download the CPU parameter again.
16#001F	The watchdog timer is set incorrectly.	Set the CPU parameter in HWCONFIG again, and download the CPU parameter again.
16#0020	The setting of the fixed scan time is incorrect.	Set the CPU parameter in HWCONFIG again, and download the CPU parameter again.
16#0021	The setting of the fixed scan time is incorrect.	Set the CPU parameter in HWCONFIG again, and download the CPU parameter again.
16#0022	The CPU parameter downloaded to the PLC is incorrect.	Set the CPU parameter in HWCONFIG again, and download the CPU parameter again.

Error code	Description	Remedy
16#0023	The PLC parameter: the state of Y device (STOP->RUN) is set incorrectly.	Set the CPU parameter in HWCONFIG again, and download the CPU parameter again.
16#0050	The memories in the latched special auxiliary relays are abnormal.	After users reset the CPU module or restore it to the factory setting, they can download the program and the parameter again.
16#0051	The latched special data registers are abnormal.	After users reset the CPU module or restore it to the factory setting, they can download the program and the parameter again.
16#0052	The memories in the latched auxiliary relays are abnormal.	After users reset the CPU module or restore it to the factory setting, they can download the program and the parameter again.
16#0053	The latched timers are abnormal.	After users reset the CPU module or restore it to the factory setting, they can download the program and the parameter again.
16#0054	The latched counters are abnormal.	After users reset the CPU module or restore it to the factory setting, they can download the program and the parameter again.
16#0055	The latched 32-bit counters are abnormal.	After users reset the CPU module or restore it to the factory setting, they can download the program and the parameter again.
16#0056	The memories in the latched timers are abnormal.	After users reset the CPU module or restore it to the factory setting, they can download the program and the parameter again.
16#0057	The memories in the latched counters are abnormal.	After users reset the CPU module or restore it to the factory setting, they can download the program and the parameter again.
16#0058	The memories in the latched 32-bit counters are abnormal.	After users reset the CPU module or restore it to the factory setting, they can download the program and the parameter again.
16#0059	The latched data registers are abnormal.	After users reset the CPU module or restore it to the factory setting, they can download the program and the parameter again.
16#005A	The latched working registers are abnormal.	After users reset the CPU module or restore it to the factory setting, they can download the program and the parameter again.

12.2.2 ERROR LED Indicator's Blinking

Error code	Description	Remedy
16#000A	Scan timeout (SM8: The watchdog timer error)	1. Check the setting of the watchdog timer in HWCONFIG. 2. Check whether the program causes the long scan time
16#000C	The program downloaded to the PLC is incorrect.	After users compile the program again, they can download the program again.
16#000E	The program or the parameter is being downloaded, and therefore the PLC can not run.	After the program or the parameter is downloaded to the PLC, users can try to run the PLC.
16#0018	The serial port is abnormal. (SM9)	Retry the connection. If the error still occurs, please contact the factory.
16#0019	The USB is abnormal. (SM9)	Retry the connection. If the error still occurs, please contact the factory.

Error code	Description	Remedy
16#0033	The communication setting of COM1 is incorrect. (SM9)	<ol style="list-style-type: none"> 1. Check the program and the related special data registers. 2. Set the communication port parameter for the CPU module in HWCONFIG again.
16#0034	The setting of the station address of COM1 is incorrect. (SM9)	<ol style="list-style-type: none"> 1. Check the program and the related special data registers. 2. Set the communication port parameter for the CPU module in HWCONFIG again.
16#0035	The setting of the communication type of COM1 is incorrect. (SM9)	<ol style="list-style-type: none"> 1. Check the program and the related special data registers. 2. Set the communication port parameter for the CPU module in HWCONFIG again.
16#0038	The communication setting of COM2 is incorrect. (SM9)	<ol style="list-style-type: none"> 1. Check the program and the related special data registers. 2. Set the communication port parameter for the CPU module in HWCONFIG again.
16#0039	The setting of the station address of COM2 is incorrect. (SM9)	<ol style="list-style-type: none"> 1. Check the program and the related special data registers. 2. Set the communication port parameter for the CPU module in HWCONFIG again.
16#003A	The setting of the communication type of COM2 is incorrect. (SM9)	<ol style="list-style-type: none"> 1. Check the program and the related special data registers. 2. Set the communication port parameter for the CPU module in HWCONFIG again.
16#0066	An error occurs when the system is backed up.	<ol style="list-style-type: none"> 1. Check whether the memory card is normal, and whether the capacity of the memory card is large enough. 2. Retry the backup procedure. If the error still occurs, please contact the factory.
16#0067	The length of the restored system parameters exceeds the length of the CPU module system parameters.	This error code is a warning code.
16#2000	There is no END in the program in the PLC. (SM5)	<ol style="list-style-type: none"> 1. Compile the program again, and download the program again. 2. Reinstall ISPSOft, compile the program again, and download the program again.
16#2002	GOEND is used incorrectly. (SM5)	Check the program, compile the program again, and download the program again.
16#2003	The devices used in the program exceed the range. (SM0/SM5)	Check the program, compile the program again, and download the program again.
16#2004	The part of the program specified by the label used in CJ/JMP is incorrect, or the label is used repeatedly. (SM0/SM5)	Check the program, compile the program again, and download the program again.
16#2005	The N value used in MC is not the same as the corresponding N value used in MCR, or the number of N values used in MC is not the same as the number of N values used in MCR. (SM5)	Check the program, compile the program again, and download the program again.
16#2006	The N values used in MC do not start from 0, or the N values used in MC are not continuous. (SM5)	Check the program, compile the program again, and download the program again.

12

Error code	Description	Remedy
16#2007	The operands used in ZRST are not used properly. (SM5)	Check the program, compile the program again, and download the program again.
16#200A	Invalid instruction (SM5)	Check the program, compile the program again, and download the program again.
16#200B	The operand n or the other constant operands exceed the range. (SM0/SM5)	Check the program, compile the program again, and download the program again.
16#200C	The operands overlap. (SM0/SM5)	Check the program, compile the program again, and download the program again.
16#200D	An error occurs when the binary number is converted into the binary-coded decimal number. (SM0/SM5)	Check the program, compile the program again, and download the program again.
16#200E	The string does not end with 0x00. (SM0/SM5)	Check the program, compile the program again, and download the program again.
16#200F	The instruction does not support the modification by an index register. (SM5)	Check the program, compile the program again, and download the program again.
16#2010	<ol style="list-style-type: none"> 1. The instruction does not support the device. 2. Encoding error 3. The instruction is a 16-bit instruction, but the constant operand is a 32-bit code. (SM5) 	Check the program, compile the program again, and download the program again.
16#2011	The number of operands is incorrect. (SM5)	Check the program, compile the program again, and download the program again.
16#2012	Incorrect division operation (SM0/SM5).	Check the program, compile the program again, and download the program again.
16#2013	The value exceeds the range of values which can be represented by the floating-point numbers. (SM0/SM5)	Check the program, compile the program again, and download the program again.
16#2014	The task designated by TKON/TKOFF is incorrect, or exceeds the range. (SM5)	Check the program, compile the program again, and download the program again.
16#2015	There are more than 32 levels of nested program structures supported by CALL. (SM0)	Check the program, compile the program again, and download the program again.
16#2016	There are more than 32 levels of nested program structures supported by FOR/NEXT. (SM0/SM5)	Check the program, compile the program again, and download the program again.
16#2017	The number of times FOR is used is different from the number of times NEXT is used. (SM5)	Check the program, compile the program again, and download the program again.
16#2018	There is a label after FEND, but there is no SRET. There is SRET, but there is no label. (SM5)	<ol style="list-style-type: none"> 1. Compile the program again, and download the program again. 2. Reinstall ISPSOft, compile the program again, and download the program again.
16#2019	The interrupt task is not after FEND. (SM5)	<ol style="list-style-type: none"> 1. Compile the program again, and download the program again. 2. Reinstall ISPSOft, compile the program again, and download the program again.

Error code	Description	Remedy
16#201A	IRET/SRET is not after FEND. (SM5)	<ol style="list-style-type: none"> 1. Compile the program again, and download the program again. 2. Reinstall ISPSOft, compile the program again, and download the program again.
16#201B	There is an interrupt task, but there is no IRET. There is IRET, but there is not interrupt task. (SM5)	<ol style="list-style-type: none"> 1. Compile the program again, and download the program again. 2. Reinstall ISPSOft, compile the program again, and download the program again.
16#201C	End is not at the end of the program. (SM5)	<ol style="list-style-type: none"> 1. Compile the program again, and download the program again. 2. Reinstall ISPSOft, compile the program again, and download the program again.
16#201D	There is CALL, but there is no MAR. (SM5)	<ol style="list-style-type: none"> 1. Compile the program again, and download the program again. 2. Reinstall ISPSOft, compile the program again, and download the program again.
16#201E	The function code used in MODRW is incorrect. (SM102/SM103)	Check the usage of the instruction and the setting of the operands. Please refer to the explanation of the instruction MODRW in AH500 Programming Manual for more information.
16#201F	The length of the data set in MODRW is incorrect. (SM102/SM103)	Check the usage of the instruction and the setting of the operands. Please refer to the explanation of the instruction MODRW in AH500 Programming Manual for more information.
16#2020	The communication command received by using MODRW is incorrect. (SM102/SM103)	Check whether the slave supports the function code and the specified operation.
16#2021	The checksum of the command received is incorrect. (SM102/SM103)	<ol style="list-style-type: none"> 1. Check whether there is noise, and retry the sending of the command. 2. Check whether the slave operates normally.
16#2022	The format of the command used in MODRW does not conform to the ASCII format. (SM102/SM103)	Make sure that the format of the command conforms to the ASCII format.
16#2023	There is a communication timeout when MODRW is executed. (SM120/SM103)	Check whether the slave operates normally, and whether the connection is normal.
16#2024	The setting value of the communication timeout is invalid. (SM120/SM103)	<ol style="list-style-type: none"> 1. Check the program and the related special data registers. 2. Set the communication port parameter for the CPU module in HWCONFIG again.
16#2025	There is a communication timeout when RS is executed. (SM120/SM103)	Check whether the slave operates normally, and whether the connection is normal.
16#2026	The RS communication interrupt is abnormal. (SM102/104)	Check whether the interrupt service routine used with RS is downloaded.
16#2027	The execution of FWD is abnormal. (SM102/103)	Refer to AH500 Programming Manual, and check the instruction FWD.
16#2028	The execution of REV is abnormal. (SM102/103)	Refer to AH500 Programming Manual, and check the instruction REV.
16#2029	The execution of STOP is abnormal. (SM102/103)	Refer to AH500 Programming Manual, and check the instruction STOP.
16#202A	The execution of RSDT is abnormal. (SM102/103)	Refer to AH500 Programming Manual, and check the instruction RSDT.

16#202B	The execution of RSTEF is abnormal. (SM102/103)	Refer to AH500 Programming Manual, and check the instruction RSTEF.
16#202C 16#204B	I/O interrupt service routine 0-31 does not exist.	Download I/O interrupt service routine 0-31 (I/O interrupt 0-31).
16#2054 16#2127	I/O interrupt service routine 40-251 does not exist.	Download I/O interrupt service routine 40-251 (I/O interrupt 40-251).
16#2128	An action in a sequential function chart is incorrectly assigned qualifiers related to time. (SM0/SM1)	Check whether the action in the sequential function chart is assigned qualifiers related to time.
16#2129	The modifier R is assigned to an action in a sequential function chart incorrectly. (SM0/SM1)	Check whether the reset modifier assigned to the action in the sequential function chart conflicts with another modifier assigned to the action in the sequential function chart.
16#6001	Illegal IP address (SM1107)	1. Check the program and the related special data registers. 2. Set the Ethernet parameter for the CPU module in HWCONFIG again.
16#6002	Illegal netmask address (SM1107)	1. Check the program and the related special data registers. 2. Set the Ethernet parameter for the CPU module in HWCONFIG again.
16#6003	Illegal gateway mask (SM1107)	1. Check the program and the related special data registers. 2. Set the Ethernet parameter for the CPU module in HWCONFIG again.
16#6004	The IP address filter is set incorrectly. (SM1108)	Set the Ethernet parameter for the CPU module in HWCONFIG again.
16#6006	The static ARP table is set incorrectly. (SM1108)	Set the Ethernet parameter for the CPU module in HWCONFIG again.
16#6007	The NTP client service is set incorrectly. (SM1380)	Check the setting of the NTP client service, and download it again.
16#6008	Illegal network number (SM1107)	Check the network configuration in NWCONFIG, and download it again.
16#6009	Illegal node number (SM1107)	Check the network configuration in NWCONFIG, and download it again.
16#6101	The trigger in the email is set incorrectly. (SM1112)	Set the Ethernet parameter for the CPU module in HWCONFIG again.
16#6102	The interval of sending the email is set incorrectly. (SM1112)	Set the Ethernet parameter for the CPU module in HWCONFIG again.
16#6103	The device containing the data specified as the attachment exceeds the device range. (SM1112)	Set the Ethernet parameter for the CPU module in HWCONFIG again.
16#6106	The SMTP server address is incorrect. (SM1112)	Make sure that the address is correct, and set the Ethernet parameter for the CPU module in HWCONFIG again.
16#6108	SMTP authentication error (SM1112)	Check the user name, and the password. Set the Ethernet parameter for the CPU module in HWCONFIG again.
16#6110	The SMTP server needs to be authenticated. (SM1112)	Check the user name, and the password. Set the Ethernet parameter for the CPU module in HWCONFIG again.

Error code	Description	Remedy
16#6111	The specified email address does not exist. (SM1112)	1. Check whether the email address is correct. 2. Set the Ethernet parameter for the CPU module in HWCONFIG again.
16#6200	The remote IP address set in the TCP socket function is illegal. (SM1196)	1. Check the program and the related special data registers. 2. Set the Ethernet parameter for the CPU module in HWCONFIG again.
16#6209	The remote IP address set in the UDP socket function is illegal. (SM1196)	1. Check the program and the related special data registers. 2. Set the Ethernet parameter for the CPU module in HWCONFIG again.
16#6300	Only auxiliary relays, data registers, and link registers can be used in the Ether Link.	Check the setting of the Ether Link in NWCONFIG, and download it again.
16#6301	The device used in the Ether Link exceeds the device range.	Check whether the device used in the Ether Link is within the device range supported by the CPU module.
16#6302	The length of the data exchanged in the Ether Link exceeds the limit.	Check whether the length of the data exchanged in the Ether Link is within the range supported by the CPU module.
16#6305	The node used in the communication command is different from the local node.	Check the setting of the Ether Link in NWCONFIG, and download it again.
16#630A	The module ID or the setting of the module is different from the setting in the Ether Link.	1. Check the setting of the parameter in HWCONFIG. 2. Check the setting of the Ether Link in NWCONFIG.
16#630B	The setting of the netmask address for the CPU or the module is different from the setting in the Ether Link.	1. Check the setting of the parameter in HWCONFIG. 2. Check the setting of the Ether Link in NWCONFIG.
16#6500	An error occurs when a data exchange function is initialized. (SM699)	Check whether the sum of the number of Modbus TCP data exchange blocks and the number of the Ether link data exchange blocks exceeds the system specifications, and download the setting again.

12.2.3 BUS FAULT LED Indicator's Being ON

When a CPU module detects an error, the BUS FAULT LED indicator on the CPU module is ON. The BUS FAULT LED indicator on the CPU module corresponds to the ERROR LED indicator on an I/O module. If an error occurs in an I/O module, the status of the BUS FAULT LED indicator on the CPU module is the same as that of the ERROR LED indicator on the I/O module. If there are errors occurring in the I/O modules, the BUS FAULT LED indicator on the CPU module will be ON. For example, the BUS FAULT LED indicator on the CPU module will be ON if the ERROR LED indicator on I/O module A is ON and the ERROR LED indicator on I/O module B blinks. If the ERROR LED indicator on I/O module B still blinks after the error occurring in I/O module A is eliminated, the BUS FAULT LED indicator on the CPU module will blink. Please refer to sections 12.4.2~12.4.8 in this manual for more information about the LED indicators.

Users can get the remedies for the errors detected by a CPU module from the table below. If the error code which users get is not listed in the table below, users need to check whether the I/O module operates normally. Please refer to section 12.3 in this manual for more information about the troubleshooting for I/O modules.

Error code	Description	Remedy
16#0013	The I/O module can not run/stop. (SM10)	Check whether the setting of the parameter for the module is correct. If the setting is correct, please check whether the module breaks down. If the error still occurs, please contact the factory.
16#0014	The procedure of restoring the system can not be executed. (SM9)	The contents of the system backup file are incorrect, or the file does not exist in the path specified. If the file exists and the procedure of restoring the system can not be executed, please backing up the system again. If the error still occurs, please contact the factory. (Please refer to section 7.5 in AH500 Operation Manual, and section 18.2 in ISPSOft User Manual for more information about the memory card.)
16#1401	An error occurs when the data in the I/O module is accessed. (SM9)	Please contact the factory.
16#1402	The actual arrangement of the I/O modules is not consistent with the module table. (SM9)	Check whether the module table in HWCONFIG is consistent with the actual arrangement of the I/O modules.
16#1403	An error occurs when the data is read from the module. (SM9)	Check whether the module operates normally. If the error still occurs, please contact the factory.
16#1405	The setting parameter of the module is not found. (SM9)	Set the parameter in HWCONFIG again, and download it.
16#1407	A communication error occurs when the data is accessed through the auxiliary processor. (SM9)	Check whether there is noise, and eliminate the noise. If the error still occurs, please contact the factory.
16#1409	The extension backplane is disconnected. (SM9)	<ol style="list-style-type: none"> 1. Check whether the extension backplane is connected properly. 2. Check whether the extension backplane operates normally, and make sure that the extension backplane is not affected by noise.
16#140A	The communication with the extension backplane is incorrect. (SM9)	<ol style="list-style-type: none"> 1. Check whether the extension backplane is connected properly. 2. Check whether the extension backplane operates normally, and make sure that the extension backplane is not affected by noise.
16#140B	The number of network modules exceeds the limit. (SM9)	Please decrease the number of network modules to the number supported by the system.
16#140D	The ID of the actual power supply module is not the same as the ID of the power supply module set in HWCONFIG. (SM9)	Check whether the ID of the power supply module set in HWCONFIG is the same as the ID of the actual power supply module.

12.2.4 BUS FAULT LED Indicator's Blinking

If the BUS FAULT LED blinks, please check the operating state of the module. Please refer to sections 12.4.2~12.4.8 in this manual for more information about the LED indicators, and section 12.3 in this manual for more information about the troubleshooting for I/O modules.

12.2.5 Troubleshooting for EtherNet/IP

Error Code	Description	How to fix them
16#B100	I/O Connections Duplicated	<ol style="list-style-type: none"> 1. Check if the system has created the I/O connections. 2. Change the connection type to Listen Only.
16#B106	Ownership Conflict	<ol style="list-style-type: none"> 1. Check the scanner owner. 2. Reconfigure the invalid scanner. 3. Change the connection to multicast.
16#B110	Target for Connection not Configured	<ol style="list-style-type: none"> 1. Check the I/O connection status. 2. Activate the I/O connections again.
16#B111	Adapter RPI Not Supported	Check the RPI for the adapter.
16#B113	Out of Connections	<ol style="list-style-type: none"> 1. Check if the connection exceeds the limit. 2. Reduce the number of the product connection.
16#B119	Non-Listen Only Not Opened	<ol style="list-style-type: none"> 1. Check if the system has created the I/O connections. 2. Check the scanner I/O connection status.
16#B127	Invalid Originator to Target Size	Check the module number and the product setup file to see if they are matched.
16#B128	Invalid Target to Originator Size	Check the output size in the connection parameters.
16#B129	The configuration path parameters in the EDS file are mismatched.	<ol style="list-style-type: none"> 1. Check if the product information and the EDS file are matched. 2. Reload the EDS file. 3. Ask the vendor of the device for the EDS file.
16#B12D	Consumed Tag does not exist.	Check if the parameters in the consumed tag are correctly set.
16#B12E	Produced Tag does not exist.	Check if the parameters in the produced tag are correctly set.
16#B203	I/O Connection Timeout	<ol style="list-style-type: none"> 1. Check the network connection status. 2. Check if the module is working fine. 3. Increase the RPI value.
16#B204	Unconnected Request Timeout	No response from the adapter; check if the power and the network connection of the adapter are working properly.
16#B302	Network Bandwidth NOT Available for Data	<ol style="list-style-type: none"> 1. Check the I/O connection limit between the scanner and the adapter. 2. Increase the RPI value or reduce the number of the connections.
16#B315	Invalid Segment in Connection Path	Check the module number and the product setup file to see if they are matched.

12.2.6 Others

12

Error code	Description	Remedy
16#000F	The original program in the PLC is damaged.	After users compile the program again, they can download the program again.
16#0024	There is no I/O module on a backplane.	Please check whether a module exists.
16#005D	The CPU module does not detect a memory card. (SM453)	Check whether a memory card is inserted into the CPU module correctly.
16#005E	The memory card is initialized incorrectly. (SM453)	Check whether the memory card breaks down.
16#005F	A nonexistent file is read from the memory card, or a nonexistent file is written to the memory card. (SM453)	Check whether the file path is correct.
16#0060	The CPU module can not create a default folder in the memory card. (SM453)	Check whether the capacity of the memory card is large enough, or whether the memory card breaks down.
16#0061	The capacity of the memory card is not sufficient. (SM453)	Check whether the capacity of the memory card is large enough.
16#0062	The memory card is write-protected. (SM453)	Check whether the memory card is write protected.
16#0063	An error occurs when data is written to the memory card. (SM453)	Check whether the file path is correct, or whether the memory card breaks down.
16#0064	A file in the memory card can not be read. (SM453)	Check whether the file path is correct, or whether the file is damaged.
16#0065	A file in the memory card is a read-only file. (SM453)	Users need to set the file so that the file is not a read-only file.
16#1801	There is no interrupt service routine in the CPU module.	Check whether there is a corresponding interrupt task (24V low voltage interrupt service routine) in the program.
16#600A	TCP connection failure (SM1090)	<ol style="list-style-type: none"> 1. Check the actual network configuration, and check whether the number of TCP connections exceeds the upper limit supported by the CPU module. 2. Retry the TCP connection later. (This error does not cause the PLC to stop running. Users can perform the corresponding remedy by means of the related flag in the program.)
16#600B	UDP connection failure (SM1091)	<ol style="list-style-type: none"> 1. Check the actual network configuration, and check whether the number of UDP connections exceeds the upper limit supported by the CPU module. 2. Retry the TCP connection later. (This error does not cause the PLC to stop running. Users can perform the corresponding remedy by means of the related flag in the program.)
16#600C	The TCP socket has been used. (SM1109)	<ol style="list-style-type: none"> 1. Check whether the actual data access results in the use of the same socket. 2. Change the socket number, or retry the socket later. (This error does not cause the PLC to stop running. Users can perform the corresponding remedy by means of the related flag in the program.)
16#600D	The RJ45 port is not connected.	Check the communication cable.
16#600E	An RJ45 port on AH10EN-5A is not connected to a network cable.	Please check whether AH10EN-5A is connected to a network cable.

Error code	Description	Remedy
16#6100	The email connection is busy. (SM1113)	Retry the email connection later. (This error does not cause the PLC to stop running. Users can perform the corresponding remedy by means of the related flag in the program.)
16#6104	The attachment in the email does not exist. (SM1113)	Check whether the attachment exists in the memory card.
16#6105	The attachment in the email is oversized. (SM1113)	Check the size of the file which is specified as the attachment. If the size is over 2 MB, the file can not be specified as the attachment.
16#6107	There is an SMTP server response timeout. (SM1113)	<ol style="list-style-type: none"> 1. Check whether the status of the SMTP server is normal. 2. Retry the sending of the email later. (This error does not cause the PLC to stop running. Users can perform the corresponding remedy by means of the related flag in the program.)
16#6201	The local communication port set in the TCP socket function is illegal.	<ol style="list-style-type: none"> 1. Check the program and the related special data registers. 2. Set the Ethernet parameter for the CPU module in HWCONFIG again.
16#6202	The remote communication port set in the TCP socket function is illegal.	<ol style="list-style-type: none"> 1. Check the program and the related special data registers. 2. Set the Ethernet parameter for the CPU module in HWCONFIG again.
16#6203	The device from which the data is sent in the TCP socket function is illegal.	<ol style="list-style-type: none"> 1. Check the program and the related special data registers. 2. Set the Ethernet parameter for the CPU module in HWCONFIG again.
16#6204	The transmitted data length set in the TCP socket function is illegal.	<ol style="list-style-type: none"> 1. Check the program and the related special data registers. 2. Set the Ethernet parameter for the CPU module in HWCONFIG again.
16#6205	The data which is sent through the TCP socket exceeds the device range.	<ol style="list-style-type: none"> 1. Check the program and the related special data registers. 2. Set the Ethernet parameter for the CPU module in HWCONFIG again.
16#6206	The device which receives the data in the TCP socket function is illegal.	<ol style="list-style-type: none"> 1. Check the program and the related special data registers. 2. Set the Ethernet parameter for the CPU module in HWCONFIG again.
16#6207	The received data length set in the TCP socket function is illegal.	<ol style="list-style-type: none"> 1. Check the program and the related special data registers. 2. Set the Ethernet parameter for the CPU module in HWCONFIG again.
16#6208	The data which is received through the TCP socket exceeds the device range.	<ol style="list-style-type: none"> 1. Check the program and the related special data registers. 2. Set the Ethernet parameter for the CPU module in HWCONFIG again.
16#620A	The local communication port set in the UDP socket function is illegal.	<ol style="list-style-type: none"> 1. Check the program and the related special data registers. 2. Set the Ethernet parameter for the CPU module in HWCONFIG again.

Error code	Description	Remedy
16#620B	The remote communication port set in the UDP socket function is illegal.	<ol style="list-style-type: none"> 1. Check the program and the related special data registers. 2. Set the Ethernet parameter for the CPU module in HWCONFIG again.
16#620C	The device from which the data is sent in the UDP socket function is illegal.	<ol style="list-style-type: none"> 1. Check the program and the related special data registers. 2. Set the Ethernet parameter for the CPU module in HWCONFIG again.
16#620D	The transmitted data length set in the UDP socket function is illegal.	<ol style="list-style-type: none"> 1. Check the program and the related special data registers. 2. Set the Ethernet parameter for the CPU module in HWCONFIG again.
16#620E	The data which is sent through the UDP socket exceeds the device range.	<ol style="list-style-type: none"> 1. Check the program and the related special data registers. 2. Set the Ethernet parameter for the CPU module in HWCONFIG again.
16#620F	The device which receives the data in the UDP socket function is illegal.	<ol style="list-style-type: none"> 1. Check the program and the related special data registers. 2. Set the Ethernet parameter for the CPU module in HWCONFIG again.
16#6210	The received data length set in the UDP socket function is illegal.	<ol style="list-style-type: none"> 1. Check the program and the related special data registers. 2. Set the Ethernet parameter for the CPU module in HWCONFIG again.
16#6211	The data which is received through the UDP socket exceeds the device range.	<ol style="list-style-type: none"> 1. Check the program and the related special data registers. 2. Set the Ethernet parameter for the CPU module in HWCONFIG again.
16#6212	There is no response from the remote device after the timeout period.	Make sure that the remote device is connected.
16#6213	The data received exceeds the limit.	<ol style="list-style-type: none"> 1. Check the program and the related special data registers. 2. Set the Ethernet parameter for the CPU module in HWCONFIG again.
16#6214	The remote device refuses the connection.	Make sure that the remote device operates normally.
16#6215	The socket is not opened.	Check whether operational sequence in the program is correct.
16#6217	The socket is opened.	Check whether operational sequence in the program is correct.
16#6218	The data has been sent through the socket.	Check whether operational sequence in the program is correct.
16#6219	The data has been received through the socket.	Check whether operational sequence in the program is correct.
16#621A	The socket is closed.	Check whether operational sequence in the program is correct.
16#6303	The remote device in the Ether Link aborts the connection.	<ol style="list-style-type: none"> 1. Check the connection and the status of the remote device. 2. Check whether the remote device supports the Ether Link.
16#6304	The connection in the Ether Link is busy.	<ol style="list-style-type: none"> 1. Check whether the number of connections in the Ether Link exceeds the system load. 2. Retry the connection in the Ether Link later.

Error code	Description	Remedy
16#6309	The remote device in the Ether Link does not respond after the timeout period.	1. Check whether the CPU module in the Ether Link operates normally. 2. Check whether the CPU modules are connected normally.
16#6400	The number of TCP connections reaches the upper limit, or the flag which is related to the sending of the data is not set to ON.	1. Check whether the flag which is related to the sending of the data in the program is modified. 2. Retry the setting of the flag and the sending of the packet.
16#6401	The remote device aborts the connection.	Check whether the remote device support the Modbus port (502).
16#6402	There is no response from the remote device after the timeout period.	Check whether the remote device operate normally.
16#6403	The remote IP address used in the applied instruction is illegal.	Check whether the program is correct.
16#6404	The Modbus function code not supported is received.	Check the command transmitted from the remote device.
16#6405	The number of data which will be received is not consistent with the actual length of the data.	Check the command transmitted from the remote device.
16#6501	The remote device involved in the data exchange does not respond after the timeout period. (SM828~SM955)	Check the device whose connection number corresponds to the error flag, and check whether it is connected normally.
16#6502	The remote device involved in the data exchange does not respond correctly. (SM828~SM955)	Check the device whose connection number corresponds to the error flag, and check whether it is connected normally.
16#6600	The network number which receives the command exceeds the range.	Check the command transmitted from the remote device.
16#6601	The network is undefined in the network configuration parameter.	Check the network configuration in NWCONFIG, and download it again.
16#6604	The number of routing connections reaches the upper limit.	Resend the packet later. ((This error does not cause the PLC to stop running. Users can perform the corresponding remedy by means of the related flag in the program.)
16#6605	The unexpected packet is received.	Check the command transmitted from the remote device.
16#6606	There is a routing response timeout.	1. Check the network configuration in NWCONFIG. 2. Check whether the setting of the communication timeout conform to the practical application.
16#6700	An error occurs when a Modbus TCP data exchange is initialized.	Please check setting values, and download them again.
16#6701	Modbus TCP data exchange timeout	Please check whether the remote device supports the Modbus communication protocol.
16#6702	The data received by means of a Modbus TCP data exchange is incorrect.	Please check whether the remote device supports the Modbus communication protocol.
16#7002	The CPU module does not support the function.	Please check the version of the firmware installed on the CPU module.
16#7203	Invalid access code	Please check the contents of the packet sent by the remote device.
16#7401	Function code error	Please check the contents of the packet sent by the remote device.

Error code	Description	Remedy
16#7402	The size of a packet exceeds the maximum data length.	Please check the contents of the packet sent by the remote device.
16#7404	Packet format error	Please check the contents of the packet sent by the remote device.
16#7405	The number of bytes is incorrect.	Please check the contents of the packet sent by the remote device.
16#7406	Checksum error	Please check the contents of the packet sent by the remote device.
16#7407	There are non-ASCII characters in a command.	Please check the contents of the packet sent by the remote device.
16#7408	The PLC is running.	When the PLC is running, data such as a program and CPU parameters can not be downloaded to the PLC.
16#740A	Data is being written to the memory in the PLC or data fails to be written to the memory in the PLC.	Data is being written to the flash memory/SD card. Please try again later.
16#740B	The CPU module is being reset, or the values in the latching devices are being cleared.	The CPU module is being reset, or the values in the latching devices are being cleared. Please try again later.
16#740C	The backplane number in a communication command is incorrect.	Please check the version of the firmware installed on the CPU module and the version of ISPSOft, and contact the factory.
16#740D	The slot number in a communication command is incorrect.	Please check the version of the firmware installed on the CPU module and the version of ISPSOft, and contact the factory.
16#740E	An error occurs when the the data in the memory in the PLC is cleared.	Please try agin. If the error still occurs, please contact the factory.
16#740F	Communication timeout	Please check whether the remote device operates normally.
16#7410	The function code in a reply command is incorrect.	Please check the contents of the packet sent by the remote device.
16#7412	Owing to the fact that SW1 is ON, data can not be downloaded to the CPU module.	Please make sure that SW1 is OFF.
16#757D	The remaining number of PLC password guesses is 0.	Please power the CPU module again.
16#757E	The PLC password entered is incorrect.	Please check whether the PLC password entered is correct.
16#8105	The contents of the program downloaded are incorrect. The program syntax is incorrect.	1. Check whether the program syntax which is not supported by the CPU module is used, and check whether the version of the firmware has its special limitation. 2. Check whether the version of ISPSOft used to create the program is the same as the version of ISPSOft used now.
16#8106	The contents of the program downloaded are incorrect. The length of the execution code exceeds the limit.	1. Shorten the length of the program, and download the program again. 2. Check whether the version of ISPSOft used to create the program is the same as the version of ISPSOft used now.

Error code	Description	Remedy
16#8107	The contents of the program downloaded are incorrect. The length of the source code exceeds the limit.	<ol style="list-style-type: none"> 1. Shorten the length of the program, and download the program again. 2. Check whether the version of ISPSOft used to create the program is the same as the version of ISPSOft used now.
16#8230	A CPU parameter downloaded is incorrect. The IP address is illegal.	Please check the Ethernet parameters downloaded.
16#8231	A CPU parameter downloaded is incorrect. The netmask address is illegal.	Please check the Ethernet parameters downloaded.
16#8232	A CPU parameter downloaded is incorrect. The gateway address is illegal.	Please check the Ethernet parameters downloaded.
16#8233	A CPU parameter downloaded is incorrect. The IP address filter is set incorrectly.	Please check the Ethernet parameters downloaded.
16#8235	A CPU parameter downloaded is incorrect. The static ARP table is set incorrectly.	<ol style="list-style-type: none"> 1. Check the Ethernet parameters for the CPU module in HWCONFIG. 2. Check whether the version of HWCONFIG is compatible with the version of the CPU module.
16#8236	A CPU parameter downloaded is incorrect. The NTP client service is set incorrectly.	<ol style="list-style-type: none"> 1. Check the Ethernet parameters for the CPU module in HWCONFIG. 2. Check whether the version of HWCONFIG is compatible with the version of the CPU module.
16#8239	A CPU parameter downloaded is incorrect. The email sending function is set incorrectly.	<ol style="list-style-type: none"> 1. Check the Ethernet parameters for the CPU module in HWCONFIG. 2. Check whether the version of HWCONFIG is compatible with the version of the CPU module.
16#823A	A CPU parameter downloaded is incorrect. The condition for the sending of an email is set incorrectly.	<ol style="list-style-type: none"> 1. Check the Ethernet parameters for the CPU module in HWCONFIG. 2. Check whether the version of HWCONFIG is compatible with the version of the CPU module.
16#823B	A CPU parameter downloaded is incorrect. A TCP socket is set incorrectly.	<ol style="list-style-type: none"> 1. Check the Ethernet parameters for the CPU module in HWCONFIG. 2. Check whether the version of HWCONFIG is compatible with the version of the CPU module.
16#823C	A CPU parameter downloaded is incorrect. A UDP socket is set incorrectly.	<ol style="list-style-type: none"> 1. Check the Ethernet parameters for the CPU module in HWCONFIG. 2. Check whether the version of HWCONFIG is compatible with the version of the CPU module.
16#823E	A CPU parameter downloaded is incorrect. The web function is set incorrectly.	<ol style="list-style-type: none"> 1. Check the Ethernet parameters for the CPU module in HWCONFIG. 2. Check whether the version of HWCONFIG is compatible with the version of the CPU module.
16#8240	A CPU parameter downloaded is incorrect. The data exchange by means of Ethernet is set incorrectly	Modify the setting, and download it again.
16#8241	The setting of a DNS server is incorrect.	Modify the setting, and download it again.
16#8522	A module configuration is being scanned.	The module configuration is being scanned.
16#853B	An I/O module is not configured.	Check whether the module configuration in HWCONFIG is correct.

16#853C	An I/O module does not exist.	Check whether the module configuration in HWCONFIG is correct.
16#854B	An I/O module is not configured.	Check whether the module configuration in HWCONFIG is correct.
16#854C	An I/O module does not exist.	Check whether the module configuration in HWCONFIG is correct.
16#8572	The checksum of the module configuration table is incorrect.	Please check the version of the firmware installed on the CPU module and the version of ISPSOFT, and contact the factory.
16#8576	The checksum of the module parameter setting is incorrect.	Please check the version of the firmware installed on the CPU module and the version of ISPSOFT, and contact the factory.
16#857A	The checksum of the module parameter mapping table is incorrect.	Please check the version of the firmware installed on the CPU module and the version of ISPSOFT, and contact the factory.
16#85E1	An I/O interrupt number is incorrect.	Please check the version of the firmware installed on the CPU module and the version of ISPSOFT, and contact the factory.
16#85E2	An I/O interrupt service routine does not exist.	Check whether the corresponding interrupt service routine is downloaded to the CPU module.
16#860F	System restoration error	<ol style="list-style-type: none"> 1. The contents of the system backup file are incorrect, or the file does not exist in the path specified. 2. If the file exists and the procedure of restoring the system can not be executed, please backing up the system again. 3. If the error still occurs, please contact the factory.
16#8611	No memory card exists, or the memory card format is incorrect.	No memory card is detected. Please format the memory card, and try again.
16#8612	An error occurs when data is accessed from the memory card, or the memory card is in read-only mode.	Please make sure that the memory card is not in read-only mode, and try again.
16#8F03	A node number is undefined.	Modify the instruction and the network parameters, and download them again.
16#9A01	The setting of the data exchange for slave 1 in the PLC Link is incorrect. (SM1590)	<ol style="list-style-type: none"> 1. Check the program and the related special data registers. 2. Set the PLC Link parameter in HWCONFIG again.
16#9A02	The setting of the data exchange for slave 2 in the PLC Link is incorrect. (SM1590)	<ol style="list-style-type: none"> 1. Check the program and the related special data registers. 2. Set the PLC Link parameter in HWCONFIG again.
16#9A03	The setting of the data exchange for slave 3 in the PLC Link is incorrect. (SM1590)	<ol style="list-style-type: none"> 1. Check the program and the related special data registers. 2. Set the PLC Link parameter in HWCONFIG again.
16#9A04	The setting of the data exchange for slave 4 in the PLC Link is incorrect. (SM1590)	<ol style="list-style-type: none"> 1. Check the program and the related special data registers. 2. Set the PLC Link parameter in HWCONFIG again.
16#9A05	The setting of the data exchange for slave 5 in the PLC Link is incorrect. (SM1590)	<ol style="list-style-type: none"> 1. Check the program and the related special data registers. 2. Set the PLC Link parameter in HWCONFIG again.
16#9A06	The setting of the data exchange for slave 6 in the PLC Link is incorrect. (SM1590)	<ol style="list-style-type: none"> 1. Check the program and the related special data registers. 2. Set the PLC Link parameter in HWCONFIG again.
16#9A07	The setting of the data exchange for slave 7 in the PLC Link is incorrect. (SM1590)	<ol style="list-style-type: none"> 1. Check the program and the related special data registers. 2. Set the PLC Link parameter in HWCONFIG again.

Error code	Description	Remedy
16#9A1A	The setting of the data exchange for slave 26 in the PLC Link is incorrect. (SM1590)	1. Check the program and the related special data registers. 2. Set the PLC Link parameter in HWCONFIG again.
16#9A1B	The setting of the data exchange for slave 27 in the PLC Link is incorrect. (SM1590)	1. Check the program and the related special data registers. 2. Set the PLC Link parameter in HWCONFIG again.
16#9A1C	The setting of the data exchange for slave 28 in the PLC Link is incorrect. (SM1590)	1. Check the program and the related special data registers. 2. Set the PLC Link parameter in HWCONFIG again.
16#9A1D	The setting of the data exchange for slave 29 in the PLC Link is incorrect. (SM1590)	1. Check the program and the related special data registers. 2. Set the PLC Link parameter in HWCONFIG again.
16#9A1E	The setting of the data exchange for slave 30 in the PLC Link is incorrect. (SM1590)	1. Check the program and the related special data registers. 2. Set the PLC Link parameter in HWCONFIG again.
16#9A1F	The setting of the data exchange for slave 31 in the PLC Link is incorrect. (SM1590)	1. Check the program and the related special data registers. 2. Set the PLC Link parameter in HWCONFIG again.
16#9A20	The setting of the data exchange for slave 32 in the PLC Link is incorrect. (SM1590)	1. Check the program and the related special data registers. 2. Set the PLC Link parameter in HWCONFIG again.
16#9A21	An error occurs when the master communicates with slave 1 in the PLC Link. (SM1591)	1. Check the communication setting in the master, and the communication setting in slave 1. 2. Check the communication cable.
16#9A22	An error occurs when the master communicates with slave 2 in the PLC Link. (SM1591)	1. Check the communication setting in the master, and the communication setting in slave 2. 2. Check the communication cable.
16#9A23	An error occurs when the master communicates with slave 3 in the PLC Link. (SM1591)	1. Check the communication setting in the master, and the communication setting in slave 3. 2. Check the communication cable.
16#9A24	An error occurs when the master communicates with slave 4 in the PLC Link. (SM1591)	1. Check the communication setting in the master, and the communication setting in slave 4. 2. Check the communication cable.
16#9A25	An error occurs when the master communicates with slave 5 in the PLC Link. (SM1591)	1. Check the communication setting in the master, and the communication setting in slave 5. 2. Check the communication cable.
16#9A26	An error occurs when the master communicates with slave 6 in the PLC Link. (SM1591)	1. Check the communication setting in the master, and the communication setting in slave 6. 2. Check the communication cable.
16#9A27	An error occurs when the master communicates with slave 7 in the PLC Link. (SM1591)	1. Check the communication setting in the master, and the communication setting in slave 7. 2. Check the communication cable.
16#9A28	An error occurs when the master communicates with slave 8 in the PLC Link. (SM1591)	1. Check the communication setting in the master, and the communication setting in slave 8. 2. Check the communication cable.
16#9A29	An error occurs when the master communicates with slave 9 in the PLC Link. (SM1591)	1. Check the communication setting in the master, and the communication setting in slave 9. 2. Check the communication cable.
16#9A2A	An error occurs when the master communicates with slave 10 in the PLC Link. (SM1591)	1. Check the communication setting in the master, and the communication setting in slave 10. 2. Check the communication cable.
16#9A2B	An error occurs when the master communicates with slave 11 in the PLC Link. (SM1591)	1. Check the communication setting in the master, and the communication setting in slave 11. 2. Check the communication cable.

Error code	Description	Remedy
16#9A3E	An error occurs when the master communicates with slave 30 in the PLC Link. (SM1591)	1. Check the communication setting in the master, and the communication setting in slave 30. 2. Check the communication cable.
16#9A3F	An error occurs when the master communicates with slave 31 in the PLC Link. (SM1591)	1. Check the communication setting in the master, and the communication setting in slave 31. 2. Check the communication cable.
16#9A40	An error occurs when the master communicates with slave 32 in the PLC Link. (SM1591)	1. Check the communication setting in the master, and the communication setting in slave 32. 2. Check the communication cable.
16#9A41	There is no response from slave 1 in the PLC Link. (SM1592)	1. Check the communication setting in the master, and the communication setting in slave 1. 2. Check the communication cable.
16#9A42	There is no response from slave 2 in the PLC Link. (SM1592)	1. Check the communication setting in the master, and the communication setting in slave 2. 2. Check the communication cable.
16#9A43	There is no response from slave 3 in the PLC Link. (SM1592)	1. Check the communication setting in the master, and the communication setting in slave 3. 2. Check the communication cable.
16#9A44	There is no response from slave 4 in the PLC Link. (SM1592)	1. Check the communication setting in the master, and the communication setting in slave 4. 2. Check the communication cable.
16#9A45	There is no response from slave 5 in the PLC Link. (SM1592)	1. Check the communication setting in the master, and the communication setting in slave 5. 2. Check the communication cable.
16#9A46	There is no response from slave 6 in the PLC Link. (SM1592)	1. Check the communication setting in the master, and the communication setting in slave 6. 2. Check the communication cable.
16#9A47	There is no response from slave 7 in the PLC Link. (SM1592)	1. Check the communication setting in the master, and the communication setting in slave 7. 2. Check the communication cable.
16#9A48	There is no response from slave 8 in the PLC Link. (SM1592)	1. Check the communication setting in the master, and the communication setting in slave 8. 2. Check the communication cable.
16#9A49	There is no response from slave 9 in the PLC Link. (SM1592)	1. Check the communication setting in the master, and the communication setting in slave 9. 2. Check the communication cable.
16#9A4A	There is no response from slave 10 in the PLC Link. (SM1592)	1. Check the communication setting in the master, and the communication setting in slave 10. 2. Check the communication cable.
16#9A4B	There is no response from slave 11 in the PLC Link. (SM1592)	1. Check the communication setting in the master, and the communication setting in slave 11. 2. Check the communication cable.
16#9A4C	There is no response from slave 12 in the PLC Link. (SM1592)	1. Check the communication setting in the master, and the communication setting in slave 12. 2. Check the communication cable.
16#9A4D	There is no response from slave 13 in the PLC Link. (SM1592)	1. Check the communication setting in the master, and the communication setting in slave 13. 2. Check the communication cable.
16#9A4E	There is no response from slave 14 in the PLC Link. (SM1592)	1. Check the communication setting in the master, and the communication setting in slave 14. 2. Check the communication cable.
16#9A4F	There is no response from slave 15 in the PLC Link. (SM1592)	1. Check the communication setting in the master, and the communication setting in slave 15. 2. Check the communication cable.

Error code	Description	Remedy
16#9A50	There is no response from slave 16 in the PLC Link. (SM1592)	1. Check the communication setting in the master, and the communication setting in slave 16. 2. Check the communication cable.
16#9A51	There is no response from slave 17 in the PLC Link. (SM1592)	1. Check the communication setting in the master, and the communication setting in slave 17. 2. Check the communication cable.
16#9A52	There is no response from slave 18 in the PLC Link. (SM1592)	1. Check the communication setting in the master, and the communication setting in slave 18. 2. Check the communication cable.
16#9A53	There is no response from slave 19 in the PLC Link. (SM1592)	1. Check the communication setting in the master, and the communication setting in slave 19. 2. Check the communication cable.
16#9A54	There is no response from slave 20 in the PLC Link. (SM1592)	1. Check the communication setting in the master, and the communication setting in slave 20. 2. Check the communication cable.
16#9A55	There is no response from slave 21 in the PLC Link. (SM1592)	1. Check the communication setting in the master, and the communication setting in slave 21. 2. Check the communication cable.
16#9A56	There is no response from slave 22 in the PLC Link. (SM1592)	1. Check the communication setting in the master, and the communication setting in slave 22. 2. Check the communication cable.
16#9A57	There is no response from slave 23 in the PLC Link. (SM1592)	1. Check the communication setting in the master, and the communication setting in slave 23. 2. Check the communication cable.
16#9A58	There is no response from slave 24 in the PLC Link. (SM1592)	1. Check the communication setting in the master, and the communication setting in slave 24. 2. Check the communication cable.
16#9A59	There is no response from slave 25 in the PLC Link. (SM1592)	1. Check the communication setting in the master, and the communication setting in slave 25. 2. Check the communication cable.
16#9A5A	There is no response from slave 26 in the PLC Link. (SM1592)	1. Check the communication setting in the master, and the communication setting in slave 26. 2. Check the communication cable.
16#9A5B	There is no response from slave 27 in the PLC Link. (SM1592)	1. Check the communication setting in the master, and the communication setting in slave 27. 2. Check the communication cable.
16#9A5C	There is no response from slave 28 in the PLC Link. (SM1592)	1. Check the communication setting in the master, and the communication setting in slave 28. 2. Check the communication cable.
16#9A5D	There is no response from slave 29 in the PLC Link. (SM1592)	1. Check the communication setting in the master, and the communication setting in slave 29. 2. Check the communication cable.
16#9A5E	There is no response from slave 30 in the PLC Link. (SM1592)	1. Check the communication setting in the master, and the communication setting in slave 30. 2. Check the communication cable.
16#9A5F	There is no response from slave 31 in the PLC Link. (SM1592)	1. Check the communication setting in the master, and the communication setting in slave 31. 2. Check the communication cable.
16#9A60	There is no response from slave 32 in the PLC Link. (SM1592)	1. Check the communication setting in the master, and the communication setting in slave 32. 2. Check the communication cable.
16#9A61	The setting of the PLC Link mode is incorrect. (SM1589)	Make sure that SM1586 and SM1587 are not both ON.

Error code	Description	Remedy
16#9A62	The number of polling cycles in the PLC Link is incorrect. (SM1592)	If the PLC Link is in the manual mode, please make sure that the number of polling cycles is within the range between 1 and 65535.
16#9A63	There is a handshaking timeout when the CPU module establishes a connection with the network module. (SM1596)	Check whether the network module operates normally.
16#9A64	There is no network module parameter in the CPU module. (SM1596)	Download the parameter in HWCONFIG again.
16#9B21	An error occurs when COM2 communicates with slave 1 by Modbus.	1. Check the communication setting in the master, and the communication setting in slave 1. 2. Check the communication cable.
16#9B22	An error occurs when COM2 communicates with slave 2 by Modbus.	1. Check the communication setting in the master, and the communication setting in slave 2. 2. Check the communication cable.
16#9B23	An error occurs when COM2 communicates with slave 3 by Modbus.	1. Check the communication setting in the master, and the communication setting in slave 3. 2. Check the communication cable.
16#9B24	An error occurs when COM2 communicates with slave 4 by Modbus.	1. Check the communication setting in the master, and the communication setting in slave 4. 2. Check the communication cable.
16#9B25	An error occurs when COM2 communicates with slave 5 by Modbus.	1. Check the communication setting in the master, and the communication setting in slave 5. 2. Check the communication cable.
16#9B26	An error occurs when COM2 communicates with slave 6 by Modbus.	1. Check the communication setting in the master, and the communication setting in slave 6. 2. Check the communication cable.
16#9B27	An error occurs when COM2 communicates with slave 7 by Modbus.	1. Check the communication setting in the master, and the communication setting in slave 7. 2. Check the communication cable.
16#9B28	An error occurs when COM2 communicates with slave 8 by Modbus.	1. Check the communication setting in the master, and the communication setting in slave 8. 2. Check the communication cable.
16#9B29	An error occurs when COM2 communicates with slave 9 by Modbus.	1. Check the communication setting in the master, and the communication setting in slave 9. 2. Check the communication cable.
16#9B2A	An error occurs when COM2 communicates with slave 10 by Modbus.	1. Check the communication setting in the master, and the communication setting in slave 10. 2. Check the communication cable.
16#9B2B	An error occurs when COM2 communicates with slave 11 by Modbus.	1. Check the communication setting in the master, and the communication setting in slave 11. 2. Check the communication cable.
16#9B2C	An error occurs when COM2 communicates with slave 12 by Modbus.	1. Check the communication setting in the master, and the communication setting in slave 12. 2. Check the communication cable.
16#9B2D	An error occurs when COM2 communicates with slave 13 by Modbus.	1. Check the communication setting in the master, and the communication setting in slave 13. 2. Check the communication cable.
16#9B2E	An error occurs when COM2 communicates with slave 14 by Modbus.	1. Check the communication setting in the master, and the communication setting in slave 14. 2. Check the communication cable.

16#9B41	COM2 receives no response from slave 1 by Modbus.	1. Check the communication setting in the master, and the communication setting in slave 1. 2. Check the communication cable.
16#9B42	COM2 receives no response from slave 2 by Modbus.	1. Check the communication setting in the master, and the communication setting in slave 2. 2. Check the communication cable.
16#9B43	COM2 receives no response from slave 3 by Modbus.	1. Check the communication setting in the master, and the communication setting in slave 3. 2. Check the communication cable.
16#9B44	COM2 receives no response from slave 4 by Modbus.	1. Check the communication setting in the master, and the communication setting in slave 4. 2. Check the communication cable.
16#9B45	COM2 receives no response from slave 5 by Modbus.	1. Check the communication setting in the master, and the communication setting in slave 5. 2. Check the communication cable.
16#9B46	COM2 receives no response from slave 6 by Modbus.	1. Check the communication setting in the master, and the communication setting in slave 6. 2. Check the communication cable.
16#9B47	COM2 receives no response from slave 7 by Modbus.	1. Check the communication setting in the master, and the communication setting in slave 7. 2. Check the communication cable.
16#9B48	COM2 receives no response from slave 8 by Modbus.	1. Check the communication setting in the master, and the communication setting in slave 8. 2. Check the communication cable.
16#9B49	COM2 receives no response from slave 9 by Modbus.	1. Check the communication setting in the master, and the communication setting in slave 9. 2. Check the communication cable.
16#9B4A	COM2 receives no response from slave 10 by Modbus.	1. Check the communication setting in the master, and the communication setting in slave 10. 2. Check the communication cable.
16#9B4B	COM2 receives no response from slave 11 by Modbus.	1. Check the communication setting in the master, and the communication setting in slave 11. 2. Check the communication cable.
16#9B4C	COM2 receives no response from slave 12 by Modbus.	1. Check the communication setting in the master, and the communication setting in slave 12. 2. Check the communication cable.
16#9B4D	COM2 receives no response from slave 13 by Modbus.	1. Check the communication setting in the master, and the communication setting in slave 13. 2. Check the communication cable.
16#9B4E	COM2 receives no response from slave 14 by Modbus.	1. Check the communication setting in the master, and the communication setting in slave 14. 2. Check the communication cable.
16#9B4F	COM2 receives no response from slave 15 by Modbus.	1. Check the communication setting in the master, and the communication setting in slave 15. 2. Check the communication cable.
16#9B50	COM2 receives no response from slave 16 by Modbus.	1. Check the communication setting in the master, and the communication setting in slave 16. 2. Check the communication cable.
16#9B51	COM2 receives no response from slave 17 by Modbus.	1. Check the communication setting in the master, and the communication setting in slave 17. 2. Check the communication cable.
16#9B52	COM2 receives no response from slave 18 by Modbus.	1. Check the communication setting in the master, and the communication setting in slave 18. 2. Check the communication cable.

16#9B53	COM2 receives no response from slave 19 by Modbus.	1. Check the communication setting in the master, and the communication setting in slave 19. 2. Check the communication cable.
16#9B54	COM2 receives no response from slave 20 by Modbus.	1. Check the communication setting in the master, and the communication setting in slave 20. 2. Check the communication cable.
16#9B55	COM2 receives no response from slave 21 by Modbus.	1. Check the communication setting in the master, and the communication setting in slave 21. 2. Check the communication cable.
16#9B56	COM2 receives no response from slave 22 by Modbus.	1. Check the communication setting in the master, and the communication setting in slave 22. 2. Check the communication cable.
16#9B57	COM2 receives no response from slave 23 by Modbus.	1. Check the communication setting in the master, and the communication setting in slave 23. 2. Check the communication cable.
16#9B58	COM2 receives no response from slave 24 by Modbus.	1. Check the communication setting in the master, and the communication setting in slave 24. 2. Check the communication cable.
16#9B59	COM2 receives no response from slave 25 by Modbus.	1. Check the communication setting in the master, and the communication setting in slave 25. 2. Check the communication cable.
16#9B5A	COM2 receives no response from slave 26 by Modbus.	1. Check the communication setting in the master, and the communication setting in slave 26. 2. Check the communication cable.
16#9B5B	COM2 receives no response from slave 27 by Modbus.	1. Check the communication setting in the master, and the communication setting in slave 27. 2. Check the communication cable.
16#9B5C	COM2 receives no response from slave 28 by Modbus.	1. Check the communication setting in the master, and the communication setting in slave 28. 2. Check the communication cable.
16#9B5D	COM2 receives no response from slave 29 by Modbus.	1. Check the communication setting in the master, and the communication setting in slave 29. 2. Check the communication cable.
16#9B5E	COM2 receives no response from slave 30 by Modbus.	1. Check the communication setting in the master, and the communication setting in slave 30. 2. Check the communication cable.
16#9B5F	COM2 receives no response from slave 31 by Modbus.	1. Check the communication setting in the master, and the communication setting in slave 31. 2. Check the communication cable.
16#9B60	COM2 receives no response from slave 32 by Modbus.	1. Check the communication setting in the master, and the communication setting in slave 32. 2. Check the communication cable.

12.3 Troubleshooting for I/O Modules

- **The introduction of modules**

Digital I/O modules, analog I/O modules, network modules, temperature measurement modules, and motion control modules can be installed in an AH500 system. Please refer to AH500 Module Manual for more information about the specifications for I/O modules. The error codes and the remedies for the errors are listed below.

12.3.1 Troubleshooting for Analog I/O Modules and Temperature Measurement Modules

12

Error code	Description	Remedy
16#A000	The signal received by channel 0 exceeds the range of inputs which can be received by the hardware. (The ERROR LED indicator blinks.)	Check the module parameter in HWCONFIG. Check whether the signal received by channel 0 exceeds the range of inputs which can be received by the hardware.
16#A001	The signal received by channel 1 exceeds the range of inputs which can be received by the hardware. (The ERROR LED indicator blinks.)	Check the module parameter in HWCONFIG. Check whether the signal received by channel 1 exceeds the range of inputs which can be received by the hardware.
16#A002	The signal received by channel 2 exceeds the range of inputs which can be received by the hardware. (The ERROR LED indicator blinks.)	Check the module parameter in HWCONFIG. Check whether the signal received by channel 2 exceeds the range of inputs which can be received by the hardware.
16#A003	The signal received by channel 3 exceeds the range of inputs which can be received by the hardware. (The ERROR LED indicator blinks.)	Check the module parameter in HWCONFIG. Check whether the signal received by channel 3 exceeds the range of inputs which can be received by the hardware.
16#A004	The signal received by channel 4 exceeds the range of inputs which can be received by the hardware. (The ERROR LED indicator blinks.)	Check the module parameter in HWCONFIG. Check whether the signal received by channel 4 exceeds the range of inputs which can be received by the hardware.
16#A005	The signal received by channel 5 exceeds the range of inputs which can be received by the hardware. (The ERROR LED indicator blinks.)	Check the module parameter in HWCONFIG. Check whether the signal received by channel 5 exceeds the range of inputs which can be received by the hardware.
16#A006	The signal received by channel 6 exceeds the range of inputs which can be received by the hardware. (The ERROR LED indicator blinks.)	Check the module parameter in HWCONFIG. Check whether the signal received by channel 6 exceeds the range of inputs which can be received by the hardware.
16#A007	The signal received by channel 7 exceeds the range of inputs which can be received by the hardware. (The ERROR LED indicator blinks.)	Check the module parameter in HWCONFIG. Check whether the signal received by channel 7 exceeds the range of inputs which can be received by the hardware.
16#A400	The signal received by channel 0 exceeds the range of inputs which can be received by the hardware. (The ERROR LED indicator is ON.)	Check the module parameter in HWCONFIG. Check whether the signal received by channel 0 exceeds the range of inputs which can be received by the hardware.
16#A401	The signal received by channel 1 exceeds the range of inputs which can be received by the hardware. (The ERROR LED indicator is ON.)	Check the module parameter in HWCONFIG. Check whether the signal received by channel 1 exceeds the range of inputs which can be received by the hardware.

Error code	Description	Remedy
16#A402	The signal received by channel 2 exceeds the range of inputs which can be received by the hardware. (The ERROR LED indicator is ON.)	Check the module parameter in HWCONFIG. Check whether the signal received by channel 2 exceeds the range of inputs which can be received by the hardware.
16#A403	The signal received by channel 3 exceeds the range of inputs which can be received by the hardware. (The ERROR LED indicator is ON.)	Check the module parameter in HWCONFIG. Check whether the signal received by channel 3 exceeds the range of inputs which can be received by the hardware.
16#A404	The signal received by channel 4 exceeds the range of inputs which can be received by the hardware. (The ERROR LED indicator is ON.)	Check the module parameter in HWCONFIG. Check whether the signal received by channel 4 exceeds the range of inputs which can be received by the hardware.
16#A405	The signal received by channel 5 exceeds the range of inputs which can be received by the hardware. (The ERROR LED indicator is ON.)	Check the module parameter in HWCONFIG. Check whether the signal received by channel 5 exceeds the range of inputs which can be received by the hardware.
16#A406	The signal received by channel 6 exceeds the range of inputs which can be received by the hardware. (The ERROR LED indicator is ON.)	Check the module parameter in HWCONFIG. Check whether the signal received by channel 6 exceeds the range of inputs which can be received by the hardware.
16#A407	The signal received by channel 7 exceeds the range of inputs which can be received by the hardware. (The ERROR LED indicator is ON.)	Check the module parameter in HWCONFIG. Check whether the signal received by channel 7 exceeds the range of inputs which can be received by the hardware.
16#A600	Hardware failure	1. Check whether the backplane is normal. 2. Check whether the module operate normally.
16#A601	The external voltage is abnormal.	Check whether the external 24 V power supply to the module is normal.
16#A602	Internal error The CJC is abnormal.	Please contact the factory.
16#A603	Internal error The factory correction is abnormal.	Please contact the factory.
16#A800	The signal received by channel 0 exceeds the range of inputs which can be received by the hardware. (The ERROR LED indicator is OFF.)	Check the module parameter in HWCONFIG. Check whether the signal received by channel 0 exceeds the range of inputs which can be received by the hardware.
16#A801	The signal received by channel 1 exceeds the range of inputs which can be received by the hardware. (The ERROR LED indicator is OFF.)	Check the module parameter in HWCONFIG. Check whether the signal received by channel 1 exceeds the range of inputs which can be received by the hardware.
16#A802	The signal received by channel 2 exceeds the range of inputs which can be received by the hardware. (The ERROR LED indicator is OFF.)	Check the module parameter in HWCONFIG. Check whether the signal received by channel 2 exceeds the range of inputs which can be received by the hardware.

Error code	Description	Remedy
16#A803	The signal received by channel 3 exceeds the range of inputs which can be received by the hardware. (The ERROR LED indicator is OFF.)	Check the module parameter in HWCONFIG. Check whether the signal received by channel 3 exceeds the range of inputs which can be received by the hardware.
16#A804	The signal received by channel 4 exceeds the range of inputs which can be received by the hardware. (The ERROR LED indicator is OFF.)	Check the module parameter in HWCONFIG. Check whether the signal received by channel 4 exceeds the range of inputs which can be received by the hardware.
16#A805	The signal received by channel 5 exceeds the range of inputs which can be received by the hardware. (The ERROR LED indicator is OFF.)	Check the module parameter in HWCONFIG. Check whether The signal received by channel 5 exceeds the range of inputs which can be received by the hardware.
16#A806	The signal received by channel 6 exceeds the range of inputs which can be received by the hardware. (The ERROR LED indicator is OFF.)	Check the module parameter in HWCONFIG. Check whether the signal received by channel 6 exceeds the range of inputs which can be received by the hardware.
16#A807	The signal received by channel 7 exceeds the range of inputs which can be received by the hardware. (The ERROR LED indicator is OFF.)	Check the module parameter in HWCONFIG. Check whether the signal received by channel 7 exceeds the range of inputs which can be received by the hardware.

12.3.2 Troubleshooting for AH02HC-5A/AH04HC-5A

Error code	Description	Remedy
16#A001	The linear accumulation in channel 0 exceeds the range.	To clear the linear accumulation, users need to set bit 1 in CR0 to ON by means of FROM/TO.
16#A002	The scale set for channel 0 exceeds the range.	Check the module parameter in HWCONFIG. The scale set for channel 0 should be in the range of 0 to 32767.
16#A003	The number of cycles set for channel 0 exceeds the range.	Check the module parameter in HWCONFIG. The number of cycles set for channel 0 should be in the range of 2 to 60.
16#A004	The comparison value set for channel 0 exceeds the range.	Check the module parameter in HWCONFIG. The comparison value set for channel 0 should be in the range of -999999999 to 999999999.
16#A005	A limit value set for channel 0 is incorrect.	Check the module parameter in HWCONFIG. A limit value of set for channel 0 should be in the range of -200000 to 200000.
16#A006	The interrupt number set for channel 0 exceeds the range.	Check the module parameter in HWCONFIG. The interrupt number set for channel 0 should be in the range of 0 to 31.
16#A011	The linear accumulation in channel 1 exceeds the range.	To clear the linear accumulation, users need to set bit 1 in CR28 to ON by means of FROM/TO.
16#A012	The scale set for channel 1 exceeds the range.	Check the module parameter in HWCONFIG. The scale set for channel 1 should be in the range of 0 to 32767.

Error code	Description	Remedy
16#A013	The number of cycles set for channel 1 exceeds the range.	Check the module parameter in HWCONFIG. The number of cycles set for channel 1 should be in the range of 2 to 60.
16#A014	The comparison value set for channel 1 exceeds the range.	Check the module parameter in HWCONFIG. The comparison value set for channel 1 should be in the range of -999999999 to 999999999.
16#A015	A limit value set for channel 1 is incorrect.	Check the module parameter in HWCONFIG. A limit value of set for channel 1 should be in the range of -200000 to 200000.
16#A016	The interrupt number set for channel 1 exceeds the range.	Check the module parameter in HWCONFIG. The interrupt number set for channel 1 should be in the range of 0 to 31.
16#A021	The linear accumulation in channel 2 exceeds the range.	To clear the linear accumulation, users need to set bit 1 in CR56 to ON by means of FROM/TO.
16#A022	The scale set for channel 2 exceeds the range.	Check the module parameter in HWCONFIG. The scale set for channel 2 should be in the range of 0 to 32767.
16#A023	The number of cycles set for channel 2 exceeds the range.	Check the module parameter in HWCONFIG. The number of cycles set for channel 2 should be in the range of 2 to 60.
16#A024	The comparison value set for channel 2 exceeds the range.	Check the module parameter in HWCONFIG. The comparison value set for channel 2 should be in the range of -999999999 to 999999999.
16#A025	A limit value set for channel 2 is incorrect.	Check the module parameter in HWCONFIG. A limit value of set for channel 2 should be in the range of -200000 to 200000.
16#A026	The interrupt number set for channel 2 exceeds the range.	Check the module parameter in HWCONFIG. The interrupt number set for channel 2 should be in the range of 0 to 31.
16#A031	The linear accumulation in channel 3 exceeds the range.	To clear the linear accumulation, users need to set bit 1 in CR84 to ON by means of FROM/TO.
16#A032	The scale set for channel 3 exceeds the range.	Check the module parameter in HWCONFIG. The scale set for channel 3 should be in the range of 0 to 32767.
16#A033	The number of cycles set for channel 3 exceeds the range.	Check the module parameter in HWCONFIG. The number of cycles set for channel 3 should be in the range of 2 to 60.
16#A034	The comparison value set for channel 3 exceeds the range.	Check the module parameter in HWCONFIG. The comparison value set for channel 3 should be in the range of -999999999 to 999999999.
16#A035	A limit value set for channel 3 is incorrect.	Check the module parameter in HWCONFIG. A limit value of set for channel 3 should be in the range of -200000 to 200000.
16#A036	The interrupt number set for channel 3 exceeds the range.	Check the module parameter in HWCONFIG. The interrupt number set for channel 3 should be in the range of 0 to 31.

12.3.3 Troubleshooting for AH05PM-5A/AH10PM-5A/AH15PM-5A

The programs and the setting which are mentioned in the table below are edited in PMSOFT version 2.02 or above.

Error code	Description	Remedy
16#A002	The subroutine has no data.	A program should be written in the subroutine.
16#A003	CJ, CJN, and JMP have no matching pointers.	Write the pointers which match CJ, CJN, and JMP respectively.
16#A004	There is a subroutine pointer in the main program.	The subroutine pointer can not be in the main program.
16#A005	Lack of the subroutine	The nonexistent subroutine can not be called.
16#A006	The pointer is used repeatedly in the same program.	The pointer can not be used repeatedly in the same program.
16#A007	The subroutine pointer is used repeatedly.	The subroutine pointer can not be used repeatedly.
16#A008	The pointer used in JMP is used repeatedly in different subroutines.	The pointer used in JMP can not be used repeatedly in different subroutines.
16#A009	The pointer used in JMP is the same as the pointer used in CALL.	The pointer used in JMP can not be the same as the pointer used in CALL.
16#A00A	The pointer used in JMP is the same as a subroutine pointer.	The pointer used in JMP can not be the same as a subroutine pointer.
16#A00B	Target position (I) of the single speed is incorrect.	The target position (I) of the single speed should be set correctly.
16#A00C	Target position (II) of the single-axis motion is incorrect.	Check whether target position (II) of the single-axis motion and target position (I) of the single-axis motion are in opposite directions.
16#A00D	The setting of speed (I) of the single-axis motion is incorrect.	Set the speed of the single-axis motion.
16#A00E	The setting of speed (II) of the single-axis motion is incorrect.	The setting value can not be zero.
16#A00F	The setting of the speed (V_{RT}) of returning to zero is incorrect.	Set the speed of returning to zero properly. (The setting value can not be zero.)
16#A010	The setting of the deceleration (V_{CR}) of returning to zero is incorrect.	Set the speed of returning to zero. The deceleration should be less than the speed of returning to zero. (The setting value can not be zero.)
16#A011	The setting of the JOG speed is incorrect.	The setting value can not be zero.
16#A012	The positive pulses generated by the single-axis clockwise motion are inhibited.	The error occurs because the limit sensor is triggered. Check the status of the limit sensor, and check whether the motor operates normally.
16#A013	The negative pulses generated by the single-axis counterclockwise motion are inhibited.	The error occurs because the limit sensor is triggered. Check the status of the limit sensor, and check whether the motor operates normally.
16#A014	The limit switch is reached.	The error occurs because the limit sensor is triggered. Check the status of the limit sensor, and check whether the motor operates normally.
16#A015	The device which is used exceeds the device range.	Use the device which does not exceed the device range.
16#A017	An error occurs when the device is modified by a 16-bit index register/32-bit index register.	Use the 16-bit index register/32-bit index register which does not exceed the device range.
16#A018	The conversion into the floating-point number is incorrect.	Modify the operation to prevent the abnormal number from occurring.

Error code	Description	Remedy
16#A019	The conversion into the binary-coded decimal number is incorrect.	Modify the operation to prevent the abnormal number from occurring.
16#A01A	Incorrect division operation (The divisor is 0.)	Modify the operation to prevent the divisor from being zero.
16#A01B	General program error	Modify the program to make the syntax correct.
16#A01C	LD/LDI has been used more than nine times.	Modify the program to prevent LD/LDI from being used more than nine times.
16#A01D	There is more than one level of nested program structure supported by RPT/RPE.	Modify the program to prevent more than one level of nested program structure supported by RPT/RPE from being used.
16#A01E	SRET is used between RPT and RPE.	Modify the program to prevent SRET from being used between RPT and RPE.
16#A01F	There is no M102 in the main program, or there is no M2 in the motion program.	Modify the program so that there is M102 in the main program, or modify the program so that there is M2 in the motion program.
16#A020	The wrong instruction is used, or the device used exceeds the range.	Check and modify the program to prevent the wrong instruction from being used, or check whether the device used exceeds the device range.

12.3.4 Troubleshooting for AH20MC-5A

The programs and the setting which are mentioned in the table below are edited in PMSOFT version 2.02 or above.

Error code	Description	Remedy
16#A002	The subroutine has no data.	A program should be written in the subroutine.
16#A003	CJ, CJN, and JMP have no matching pointers.	Write the pointers which match CJ, CJN, and JMP respectively.
16#A004	There is a subroutine pointer in the main program.	The subroutine pointer can not be in the main program.
16#A005	Lack of the subroutine	The nonexistent subroutine can not be called.
16#A006	The pointer is used repeatedly in the same program.	The pointer can not be used repeatedly in the same program.
16#A007	The subroutine pointer is used repeatedly.	The subroutine pointer can not be used repeatedly.
16#A008	The pointer used in JMP is used repeatedly in different subroutines.	The pointer used in JMP can not be used repeatedly in different subroutines.
16#A009	The pointer used in JMP is the same as the pointer used in CALL.	The pointer used in JMP can not be the same as the pointer used in CALL.
16#A00A	The pointer used in JMP is the same as a subroutine pointer.	The pointer used in JMP can not be the same as a subroutine pointer.
16#A00B	Target position (I) of the single speed is incorrect.	The target position (I) of the single speed should be set correctly.
16#A00C	Target position (II) of the single-axis motion is incorrect.	Check whether target position (II) of the single-axis motion and target position (I) of the single-axis motion are in opposite directions.
16#A00D	The setting of speed (I) of the single-axis motion is incorrect.	Set the speed of the single-axis motion.
16#A00E	The setting of speed (II) of the single-axis motion is incorrect.	The setting value can not be zero.
16#A00F	The setting of the speed (V_{RT}) of returning to zero is incorrect.	Set the speed of returning to zero properly. (The setting value can not be zero.)

Error code	Description	Remedy
16#A010	The setting of the deceleration (V_{CR}) of returning to zero is incorrect.	Set the speed of returning to zero. The deceleration should be less than the speed of returning to zero. (The setting value can not be zero.)
16#A011	The setting of the JOG speed is incorrect.	The setting value can not be zero.
16#A012	The positive pulses generated by the single-axis clockwise motion are inhibited.	The error occurs because the limit sensor is triggered. Check the status of the limit sensor, and check whether the motor operates normally.
16#A013	The negative pulses generated by the single-axis counterclockwise motion are inhibited.	The error occurs because the limit sensor is triggered. Check the status of the limit sensor, and check whether the motor operates normally.
16#A014	The limit switch is reached.	The error occurs because the limit sensor is triggered. Check the status of the limit sensor, and check whether the motor operates normally.
16#A015	The device which is used exceeds the device range.	Use the device which does not exceed the device range.
16#A017	An error occurs when the device is modified by a 16-bit index register/32-bit index register.	Use the 16-bit index register/32-bit index register which does not exceed the device range.
16#A018	The conversion into the floating-point number is incorrect.	Modify the operation to prevent the abnormal number from occurring.
16#A019	The conversion into the binary-coded decimal number is incorrect.	Modify the operation to prevent the abnormal number from occurring.
16#A01A	Incorrect division operation (The divisor is 0.)	Modify the operation to prevent the divisor from being zero.
16#A01B	General program error	Modify the program to make the syntax correct.
16#A01C	LD/LDI has been used more than nine times.	Modify the program to prevent LD/LDI from being used more than nine times.
16#A01D	There is more than one level of nested program structure supported by RPT/RPE.	Modify the program to prevent more than one level of nested program structure supported by RPT/RPE from being used.
16#A01E	SRET is used between RPT and RPE.	Modify the program to prevent SRET from being used between RPT and RPE.
16#A01F	There is no M102 in the main program, or there is no M2 in the motion program.	Modify the program so that there is M102 in the main program, or modify the program so that there is M2 in the motion program.
16#A020	The wrong instruction is used, or the device used exceeds the range.	Check and modify the program to prevent the wrong instruction from being used, or check whether the device used exceeds the device range.

12.3.5 Troubleshooting for AH10EN-5A

Error code	Description	Remedy
16#A001	The IP address of host 1 conflicts with another system on the network.	1. Contact the network administrator, and check whether the IP address is correct. 2. Check the module parameter in HWCONFIG.
16#A002	The IP address of host 2 conflicts with another system on the network.	1. Contact the network administrator, and check whether the IP address is correct. 2. Check the module parameter in HWCONFIG.
16#A003	DHCP for host 1 fails.	Please contact the network administrator
16#A004	DHCP for host 2 fails.	Please contact the network administrator

Error code	Description	Remedy
16#A401	Hardware error	Please restore the hardware to the factory setting. If the error still occurs, please contact the factory.
16#A402	The initialization of the system fails.	Please restore the system to the factory setting. If the error still occurs, please contact the factory.

12.3.6 Troubleshooting for AH10SCM-5A

Error code	Description	Remedy
16#A002	The setting of the UD Link is incorrect, or the communication fails.	Check the setting in SCMSOFT, and download the setting again.
16#A401	Hardware error	Please contact the factory.
16#A804	The communication through the communication port is incorrect.	<ol style="list-style-type: none"> 1. Check whether the communication cable is connected well. 2. Check the parameter in HWCONFIG, and the parameter. Download the parameter again.
16#A808	Modbus communication error	<ol style="list-style-type: none"> 1. Check whether the communication cable is connected well. 2. Check the parameter in HWCONFIG, and the parameter. Download the parameter again.

12

12.3.7 Troubleshooting for AH10DNET-5A

The parameters which are mentioned in the table below are set in DeviceNet Builder version 1.07 or above.

Error code	Description	Remedy
16#A0F0	The node ID of AH10DNET-5A is the same as other node ID on the network, or exceeds the range.	Make sure that the node ID of AH10DNET-5A is the only one on the network. If the node ID of AH10DNET-5A is not the only one on the network, please change the node ID, and supply power to AH10DNET-5A again.
16#A0F1	No slave is put on the scan list of AH10DNET-5A.	Put slaves on the scan list, and then download the scan list to AH10DNET-5A.
16#A0F2	The working voltage of AH10DNET-5A is low.	Check whether the working voltage of AH10DNET-5A and that of an AH500 series CPU module are normal.
16#A0F3	AH10DNET-5A enters the test mode.	Switch IN 1 on the module OFF, and supply power to AH10DNET-5A again.
16#A0F4	The bus of AH10DNET-5A becomes OFF.	<ol style="list-style-type: none"> 1. Check whether the communication cable is normal, and whether the shielded cable is grounded. 2. Check whether the serial transmission speeds of other devices on the network are the same. 3. Check whether the both ends of the cable are connected to 121 Ω terminal resistors. 4. Supply power to AH10DNET-5A again.
16#A0F5	AH10DNET-5A detects that there is no power supply to the DeviceNet network.	Check whether the communication cable is normal, and whether the network power supply is normal.
16#A0F6	Something is wrong with the internal memory of AH10DNET-5A.	Supply power to AH10DNET-5A again. If the error still occurs, please contact the factory.

Error code	Description	Remedy
16#A0F7	Something is wrong with the data exchange unit of AH10DNET-5A.	Supply power to AH10DNET-5A again. If the error still occurs, please contact the factory.
16#A0F8	The product ID of AH10DNET-5A is incorrect.	Supply power to AH10DNET-5A again. If the error still occurs, please contact the factory.
16#A0F9	An error occurs when the data is read from AH10DNET-5A, or when the data is written into AH10DNET-5A.	Supply power to AH10DNET-5A again. If the error still occurs, please contact the factory.
16#A0FA	The node ID of AH10DNET-5A is the same as that of the slave set on the scan list.	Method 1: Set the node ID of AH10DNET-5A again. The new node ID can not be the same as the node ID of the slave set on the scan list. Supply power to AH10DNET-5A again. Method 2: Put no slave on the scan list, and download the blank scan list to AH10DNET-5A through the simulated online mode in the software. Supply power to AH10DNET-5A again.
16#A0FB	The data exchange between AH10DNET and AH CPU failed.	Supply power to the AH10DNET and AH CPU and try to exchange data again. If the issue continues, contact the factory.
16#A0FC	Errors occur in the slaves, on the module of an AHRTU-DNET backplane, or on the AHRTU-DNET backplane connection.	<ol style="list-style-type: none"> 1. Check whether the node number has changed. 2. Check if the network connection cable is secured and working fine. 3. Check if the network transmission cable does not exceed the maximum communication distance (refer to AH500 module manual section 10.3.3 for more information). Do not exceed the maximum communication distance to ensure a stable network. 4. Check if the module on the backplane is working fine. 5. Check if the AHRTU-DNET backplane connection is working fine.

12.3.8 Troubleshooting for AH10PFBM-5A

Error code	Description	Remedy
16#A001	The master is not set.	Download appropriate setting.
16#A003	The master station enters the test mode.	Just repower it.
16#A005	A timeout occurs when chips inside the master station communicate.	Download the appropriate configuration again. If the error still occurs, please contact the factory.
16#A00B	A timeout occurs when AH10PFBM-5A exchanges data exchange with a PLC.	Repower AH10PFBM-5A . If the error still occurs, please contact the factory.
16#A402	The PLC does not assign the I/O mapping area to the master.	Assign the appropriate I/O mapping area to the master via ISPSOft.
16#A404	Master initializing error	Contact the factory if the error still exists after repowering AH10PFBM-5A.
16#A406	Internal storage unit error	Contact the factory if the error still exists after repowering AH10PFBM-5A.
16#A407	Data exchange unit error	Contact the factory if the error still exists after repowering AH10PFBM-5A.
16#A408	Master serial number detection error	Contact the factory if the error still exists after repowering AH10PFBM-5A.

Error code	Description	Remedy
16#A4E2	The master detects that the slave is offline.	<ol style="list-style-type: none"> 1. Check whether the PROFIBUS-DP bus connection is normal. 2. Check whether both of the ends of the network have terminal resistors.
16#A4E6	The master detects that an error occurs in the module connected to AHRTU-PFBS-5A.	Check the modules connected to AHRTU-PFBS-5A.

12.3.9 Troubleshooting for AH10PFBS-5A

Error code	Description	Remedy
16#A4F0	The node address of AH10PFBS-5A exceeds the valid range.	The node address of AH10PFBS-5A must be in the range of 1 to 125.
16#A4F1	Internal hardware error	If the error still exists after repowering AH10PFBS-5A, replace it with a new one.
16#A4F2	Parameter error	Check whether the GSD file AH10PFBS-5A is using is correct.
16#A4F3	Configuration error	Check whether the GSD file AH10PFBS-5A is using is correct.
16#A4F4	GPIO detection error	If the error still exists after repowering AH10PFBS-5A, replace it with a new one.
16#A4F5	AH10PFBS-5A enters the mode of factory test.	Repower AH10PFBS-5A after setting its node address between 1~125.
16#A4F6	<ol style="list-style-type: none"> 1. AH10PFBS-5A has not been connected to the PROFIBUS-DP network. 2. PROFIBUS-DP master has not configured AH10PFBS-5A slave or the configured node address of AH10PFBS-5A is inconsistent with that of the actually connected one. 	<ol style="list-style-type: none"> 1. Check whether the communication cable between AH10PFBS-5A and PROFIBUS-DP master is in normal status. 2. Ensure that AH10PFBS-5A slave has been configured to PROFIBUS-DP master and the configured node address of AH10PFBS-5A is consistent with that of the actually connected one. 3. Check whether the PROFIBUS-DP master works normally.

12.3.10 Troubleshooting for AH10COPM-5A

Error code	Description	Remedy
16#A0B0	AH10COPM-5A does not send a heartbeat message after a set period of time.	Check whether the bus cable on the CANopen network created is connected correctly.
16#A0B1	The length of a PDO that a slave station sends is not the same as the length of the PDO set in the node list.	Set the length of the PDO in the slave station again, and then download the setting to AH10COPM-5A.
16#A0B2	The master station selected does not send a node guarding message after a set period of time.	Check whether the bus cable on the CANopen network created is connected correctly.
16#A0E0	AH10COPM-5A receives an	Use the function block CANopen_EMCY to read relevant

12

Error code	Description	Remedy
	emergency message from a slave station.	information.
16#A0E1	The length of a PDO that a slave station sends is not the same as the length of the PDO set in the node list.	Set the length of the PDO in the slave station again, and then download the setting to AH10COPM-5A.
16#A0E2	AH10COPM-5A does not receive a PDO from a slave station.	Make sure that the PDOs in the slave station are set correctly.
16#A0E3	An automatic SDO is not downloaded successfully.	Make sure that the automatic SDO is set correctly.
16#A0E4	A PDO parameter is not set successfully.	Make sure that the setting of the PDO parameter is legal.
16#A0E5	A key parameter is set incorrectly.	Make sure that the slave stations connected are the same as the slave stations set.
16#A0E6	The actual network configuration is not the same as the network configuration set.	Make sure that the power supplied to the slave stations connected is normal and the network created is connected correctly.
16#A0E7	The control of the errors in a slave station is not sent after a set period of time.	
16#A0E8	The master station address is the same as a slave station address.	Set the master station address or the slave station address again, and make sure the new station address is not the same as a slave station address.
16#A0F1	No slave station is added to the node list in CANopen builder.	Add slave stations to the node list, and download the configuration to AH10COPM-5A.
16#A0F3	An error occurs in AH10COPM-5A.	Download parameters again. If the error still occurs, please replace AH10COPM-5A.
16#A0F4	The bus used is off.	Please check whether the bus cable on the CANopen network created is connected correctly, make sure that the serial transmission speeds of all the nodes on the network are the same, and power AH10COPM-5A again.
16#A0F5	The node address of AH10COPM-5A is set incorrectly.	The node address of AH10COPM-5A must be in the range of 1 to 127.
16#A0F6	Internal error: An error occurs in the manufacturing process in the factory.	Power AH10COPM-5A again. If the error still occurs, please replace AH10COPM-5A.
16#A0F7	Internal error: GPIO error	
16#A0F8	Hardware error	
16#A0F9	Low voltage	Make sure that the power supplied to AH10COPM-5A is normal.
16#A0FA	An error occurs in the firmware of AH10COPM-5A.	Power AH10COPM-5A again.
16#A0FB	The transmission registers in AH10COPM-5A are full.	Please make sure that the bus cable on the CANopen network created is connected correctly, and power AH10COPM-5A again.
16#A0FC	The reception registers in AH10COPM-5A are full.	Please make sure that the bus cable on the CANopen network created is connected correctly, and power AH10COPM-5A again.

12.4 Error Codes and LED Indicators

A. Columns

- a. Error code: If the error occurs in the system, the error code is generated.
- b. Description: The description of the error
- c. CPU status: If the error occurs, the CPU stops running, keeps running, or in the status defined by users.
 - Stop: The CPU stops running when the error occurs.
 - Continue: The CPU keeps running when the error occurs.
 - Self-defined: The status of the CPU can be defined by users. Please refer to section 8.2.1 in this manual for more information.
- d. LED indicator status: If the error occurs, the LED indicator is ON, OFF, or blinks.
 - ERROR: The system error
 - BUS FAULT: The I/O bus error
 - Module ERROR: The module error

● LED indicators

	LED indicator	Description
CPU	ERROR	The status of the CPU ON: A serious error occurs in the system. OFF: The system is normal. Blinking: A slight error occurs in the system.
	BUS FAULT	The status of the I/O bus ON: A serious error occurs in the I/O bus. OFF: The I/O bus is normal. Blinking: A slight error occurs in the I/O bus.
Module	ERROR	The status of the module ON: A serious error occurs in the module. OFF: The module is normal. Blinking: A slight error occurs in the module.

12.4.1 CPU Modules

Error code	Description	CPU Status	LED indicator status	
			ERROR	BUS FAULT
16#000A	Scan timeout (SM8: The watchdog timer error)	Stop	Blinking	Keep
16#000B	The program in the PLC is damaged.	Stop	ON	Keep
16#000C	The program downloaded to the PLC is incorrect.	Stop	Blinking	Keep
16#000D	The CPU parameter is damaged.	Stop	ON	Keep
16#000E	The program or the parameter is being downloaded, and therefore the PLC can not run.	Stop	Blinking	Keep
16#000F	The original program in the PLC is damaged.	Continue	Keep	Keep
16#0010	The access to the memory in the CPU is denied.	Stop	ON	Keep
16#0011	The PLC ID is incorrect. (SM9)	Continue	ON	Keep
16#0012	The PLC password is incorrect.	Continue	ON	Keep
16#0013	The I/O module can not run/stop. (SM10)	Stop	Keep	ON
16#0014	The procedure of restoring the system can not be executed. (SM9)	Stop	ON	ON
16#0015	The module table is incorrect. (SM10)	Stop	ON	Keep
16#0016	The module setting is incorrect. (SM10)	Stop	ON	Keep
16#0017	The device which is associated with the data register is incorrect. (SM10)	Stop	ON	Keep
16#0018	The serial port is abnormal. (SM9)	Continue	Blinking	Keep
16#0019	The USB is abnormal. (SM9)	Continue	Blinking	Keep

Error code	Description	CPU Status	LED indicator status	
			ERROR	BUS FAULT
16#001B	Timed interrupt 0 is set incorrectly.	Stop	ON	Keep
16#001C	Timed interrupt 1 is set incorrectly.	Stop	ON	Keep
16#001D	Timed interrupt 2 is set incorrectly.	Stop	ON	Keep
16#001E	Timed interrupt 3 is set incorrectly.	Stop	ON	Keep
16#001F	The watchdog timer is set incorrectly.	Stop	ON	Keep
16#0020	The setting of the fixed scan time is incorrect.	Stop	ON	Keep
16#0021	The setting of the fixed scan time is incorrect.	Stop	ON	Keep
16#0022	The CPU parameter downloaded to the PLC is incorrect.	Stop	ON	Keep
16#0023	The Y state (STOP->RUN) section in the PLC Parameter Setting window is set incorrectly.	Stop	ON	Keep
16#0024	There is no I/O module on a backplane.	Continue	Keep	Keep
16#0033	The communication setting of COM1 is incorrect. (SM9)	Continue	Blinking	Keep
16#0034	The setting of the station address of COM1 is incorrect. (SM9)	Continue	Blinking	Keep
16#0035	The setting of the communication type of COM1 is incorrect. (SM9)	Continue	Blinking	Keep
16#0038	The communication setting of COM2 is incorrect. (SM9)	Continue	Blinking	Keep
16#0039	The setting of the station address of COM2 is incorrect. (SM9)	Continue	Blinking	Keep
16#003A	The setting of the communication type of COM2 is incorrect. (SM9)	Continue	Blinking	Keep
16#0050	The memories in the latched special auxiliary relays are abnormal.	Continue	ON	Keep
16#0051	The latched special data registers are abnormal.	Continue	ON	Keep
16#0052	The memories in the latched auxiliary relays are abnormal.	Continue	ON	Keep
16#0053	The latched timers are abnormal.	Continue	ON	Keep
16#0054	The latched counters are abnormal.	Continue	ON	Keep
16#0055	The latched 32-bit counters are abnormal.	Continue	ON	Keep
16#0056	The memories in the latched timers are abnormal.	Continue	ON	Keep
16#0057	The memories in the latched counters are abnormal.	Continue	ON	Keep
16#0058	The memories in the latched 32-bit counters are abnormal.	Continue	ON	Keep
16#0059	The latched data registers are abnormal.	Continue	ON	Keep
16#005A	The latched working registers are abnormal.	Continue	ON	Keep
16#005D	The CPU module does not detect a memory card. (SM453)	Continue	Keep	Keep
16#005E	The memory card is initialized incorrectly. (SM453)	Continue	Keep	Keep
16#005F	The data is read from the inexistent file in the memory card, or the data is written into the inexistent file in the memory card. (SM453)	Continue	Keep	Keep
16#0060	The default folder can not be created in the CPU module. (SM453)	Continue	Keep	Keep
16#0061	The capacity of the memory card is not large enough. (SM453)	Continue	Keep	Keep
16#0062	The memory card is write protected. (SM453)	Continue	Keep	Keep
16#0063	An error occurs when the data is written into the memory card. (SM453)	Continue	Keep	Keep

Error code	Description	CPU Status	LED indicator status	
			ERROR	BUS FAULT
16#0064	The file in the memory card can not be read. (SM453)	Continue	Keep	Keep
16#0065	The file in the memory card is a read-only file. (SM453)	Continue	Keep	Keep
16#0066	An error occurs when the system is backed up.	Continue	Blinking	Keep
16#0067	The size of the PLC parameters restored exceeds the size of the PLC parameters of the CPU module.	Continue	Blinking	Keep
16#1401	An error occurs when the data in the I/O module is accessed. (SM9)	Stop	Keep	ON
16#1402	The actual arrangement of the I/O modules is not consistent with the module table. (SM9)	Stop	Keep	ON
16#1403	An error occurs when the data is read from the module. (SM9)	Stop	Keep	ON
16#1404	A watchdog timer error occurs in the module. (SM9)	Stop	Keep	ON
16#1405	The setting parameter of the module is not found. (SM9)	Stop	Keep	ON
16#1407	A communication error occurs when the data is accessed through the auxiliary processor. (SM9)	Continue	ON	Keep
16#1409	The extension backplane is disconnected. (SM9)	Stop	Keep	ON
16#140A	The communication with the extension backplane is incorrect. (SM9)	Stop	Keep	ON
16#140B	The number of network modules exceeds the limit. (SM9)	Stop	Keep	ON
16#1801	There is no interrupt service routine in the CPU module.	Continue	Keep	Keep
16#2000	There is no END in the program in the PLC. (SM5)	Stop	Blinking	Keep
16#2002	GOEND is used incorrectly. (SM5)	Stop	Blinking	Keep
16#2003	The devices used in the program exceed the range. (SM0/SM5)	Self-defined	Blinking	Keep
16#2004	The part of the program specified by the label used in CJ/JMP is incorrect, or the label is used repeatedly. (SM0/SM5)	Stop	Blinking	Keep
16#2005	The N value used in MC is not the same as the corresponding N value used in MCR, or the number of N values used in MC is not the same as the number of N values used in MCR. (SM5)	Stop	Blinking	Keep
16#2006	The N values used in MC do not start from 0, or the N values used in MC are not continuous. (SM5)	Stop	Blinking	Keep
16#2007	The operands used in ZRST are not used properly. (SM5)	Stop	Blinking	Keep
16#200A	Invalid instruction (SM5)	Stop	Blinking	Keep
16#200B	The operand n or the other constant operands exceed the range. (SM0/SM5)	Self-defined	Blinking	Keep
16#200C	The operands overlap. (SM0/SM5)	Self-defined	Blinking	Keep
16#200D	An error occurs when the binary number is converted into the binary-coded decimal number. (SM0/SM5)	Self-defined	Blinking	Keep
16#200E	The string does not end with 0x00. (SM0/SM5)	Self-defined	Blinking	Keep
16#200F	The instruction does not support the modification by an index register. (SM5)	Stop	Blinking	Keep

12

Error code	Description	CPU Status	LED indicator status	
			ERROR	BUS FAULT
16#2010	1. The instruction does not support the device. 2. Encoding error 3. The instruction is a 16-bit instruction, but the constant operand is a 32-bit code. (SM5)	Stop	Blinking	Keep
16#2011	The number of operands is incorrect. (SM5)	Stop	Blinking	Keep
16#2012	Incorrect division operation (SM0/SM5).	Self-defined	Blinking	Keep
16#2013	The value exceeds the range of values which can be represented by the floating-point numbers. (SM0/SM5)	Self-defined	Blinking	Keep
16#2014	The task designated by TKON/YKOFF is incorrect, or exceeds the range. (SM5)	Stop	Blinking	Keep
16#2015	There are more than 32 levels of nested program structures supported by CALL. (SM0)	Self-defined	Blinking	Keep
16#2016	There are more than 32 levels of nested program structures supported by FOR/NEXT. (SM0/SM5)	Self-defined	Blinking	Keep
16#2017	The number of times FOR is used is different from the number of times NEXT is used. (SM5)	Stop	Blinking	Keep
16#2018	There is a label after FEND, but there is no SRET. There is SRET, but there is no label. (SM5)	Stop	Blinking	Keep
16#2019	The interrupt task is not after FEND. (SM5)	Stop	Blinking	Keep
16#201A	IRET/SRET is not after FEND. (SM5)	Stop	Blinking	Keep
16#201B	There is an interrupt task, but there is no IRET. There is IRET, but there is not interrupt task. (SM5)	Stop	Blinking	Keep
16#201C	End is not at the end of the program. (SM5)	Stop	Blinking	Keep
16#201D	There is CALL, but there is no MAR. (SM5)	Stop	Blinking	Keep
16#201E	The function code used in MODRW is incorrect. (SM102/SM103)	Self-defined	Blinking	Keep
16#201F	The length of the data set in MODRW is incorrect. (SM102/SM103)	Self-defined	Blinking	Keep
16#2020	The communication command received by using MODRW is incorrect. (SM102/SM103)	Self-defined	Blinking	Keep
16#2021	The checksum of the command received is incorrect. (SM102/SM103)	Self-defined	Blinking	Keep
16#2022	The format of the command used in MODRW does not conform to the ASCII format. (SM102/SM103)	Self-defined	Blinking	Keep
16#2023	There is a communication timeout when MODRW is executed. (SM120/SM103)	Self-defined	Blinking	Keep
16#2024	The setting value of the communication timeout is invalid. (SM120/SM103)	Self-defined	Blinking	Keep
16#2025	There is a communication timeout when RS is executed. (SM120/SM103)	Self-defined	Blinking	Keep
16#2026	The interrupt number used in RS is incorrect.	Self-defined	Blinking	Keep
16#2027	The execution of FWD is abnormal. (SM102/103)	Self-defined	Blinking	Keep
16#2028	The execution of REV is abnormal. (SM102/103)	Self-defined	Blinking	Keep
16#2029	The execution of STOP is abnormal. (SM102/103)	Self-defined	Blinking	Keep
16#202A	The execution of RSDT is abnormal. (SM102/103)	Self-defined	Blinking	Keep
16#202B	The execution of RSTEF is abnormal. (SM102/103)	Self-defined	Blinking	Keep
16#202C	I/O interrupt service routine 0 does not exist.	Stop	Blinking	Keep
16#202D	I/O interrupt service routine 1 does not exist.	Stop	Blinking	Keep
16#202E	I/O interrupt service routine 2 does not exist.	Stop	Blinking	Keep

Error code	Description	CPU Status	LED indicator status	
			ERROR	BUS FAULT
16#202F	I/O interrupt service routine 3 does not exist.	Stop	Blinking	Keep
16#2030	I/O interrupt service routine 4 does not exist.	Stop	Blinking	Keep
16#2031	I/O interrupt service routine 5 does not exist.	Stop	Blinking	Keep
16#2032	I/O interrupt service routine 6 does not exist.	Stop	Blinking	Keep
16#2033	I/O interrupt service routine 7 does not exist.	Stop	Blinking	Keep
16#2034	I/O interrupt service routine 8 does not exist.	Stop	Blinking	Keep
16#2035	I/O interrupt service routine 9 does not exist.	Stop	Blinking	Keep
16#2036	I/O interrupt service routine 10 does not exist.	Stop	Blinking	Keep
16#2037	I/O interrupt service routine 11 does not exist.	Stop	Blinking	Keep
16#2038	I/O interrupt service routine 12 does not exist.	Stop	Blinking	Keep
16#2039	I/O interrupt service routine 13 does not exist.	Stop	Blinking	Keep
16#203A	I/O interrupt service routine 14 does not exist.	Stop	Blinking	Keep
16#203B	I/O interrupt service routine 15 does not exist.	Stop	Blinking	Keep
16#203C	I/O interrupt service routine 16 does not exist.	Stop	Blinking	Keep
16#203D	I/O interrupt service routine 17 does not exist.	Stop	Blinking	Keep
16#203E	I/O interrupt service routine 18 does not exist.	Stop	Blinking	Keep
16#203F	I/O interrupt service routine 19 does not exist.	Stop	Blinking	Keep
16#2040	I/O interrupt service routine 20 does not exist.	Stop	Blinking	Keep
16#2041	I/O interrupt service routine 21 does not exist.	Stop	Blinking	Keep
16#2042	I/O interrupt service routine 22 does not exist.	Stop	Blinking	Keep
16#2043	I/O interrupt service routine 23 does not exist.	Stop	Blinking	Keep
16#2044	I/O interrupt service routine 24 does not exist.	Stop	Blinking	Keep
16#2045	I/O interrupt service routine 25 does not exist.	Stop	Blinking	Keep
16#2046	I/O interrupt service routine 26 does not exist.	Stop	Blinking	Keep
16#2047	I/O interrupt service routine 27 does not exist.	Stop	Blinking	Keep
16#2048	I/O interrupt service routine 28 does not exist.	Stop	Blinking	Keep
16#2049	I/O interrupt service routine 29 does not exist.	Stop	Blinking	Keep
16#204A	I/O interrupt service routine 30 does not exist.	Stop	Blinking	Keep
16#204B	I/O interrupt service routine 31 does not exist.	Stop	Blinking	Keep
16#2054 16#2127	I/O interrupt service routine 40-251 does not exist.	Stop	Blinking	Keep
16#2128	An action in a sequential function chart is incorrectly assigned qualifiers related to time. (SM0/SM1)	Self-defined	Blinking	Keep
16#2129	The modifier R is assigned to an action in a sequential function chart incorrectly. (SM0/SM1)	Self-defined	Blinking	Keep
16#6001	Illegal IP address (SM1107)	Continue	Blinking	Keep
16#6002	Illegal netmask address (SM1107)	Continue	Blinking	Keep

12

Error code	Description	CPU Status	LED indicator status	
			ERROR	BUS FAULT
16#6003	Illegal gateway mask (SM1107)	Continue	Blinking	Keep
16#6004	The IP address filter is set incorrectly. (SM1108)	Continue	Blinking	Keep
16#6006	The static ARP table is set incorrectly. (SM1108)	Continue	Blinking	Keep
16#6008	Illegal network number (SM1107)	Continue	Blinking	Keep
16#6009	Illegal node number (SM1107)	Continue	Blinking	Keep
16#600A	TCP connection failure (SM1090)	Continue	Keep	Keep
16#600B	UDP connection failure (SM1091)	Continue	Keep	Keep
16#600C	The TCP socket has been used. (SM1109)	Continue	Keep	Keep
16#600D	The RJ45 port is not connected. (SM1100)	Continue	Keep	Keep
16#6100	The email connection is busy. (SM1113)	Continue	Keep	Keep
16#6101	The trigger in the email is set incorrectly. (SM1112)	Continue	Keep	Keep
16#6102	The interval of sending the email is set incorrectly. (SM1112)	Continue	Blinking	Keep
16#6103	The device containing the data specified as the attachment exceeds the device range. (SM1112)	Continue	Blinking	Keep
16#6104	The attachment in the email does not exist. (SM1113)	Continue	Blinking	Keep
16#6105	The attachment in the email is oversized. (SM1113)	Continue	Keep	Keep
16#6106	The SMTP server address is incorrect. (SM1112)	Continue	Keep	Keep
16#6107	There is an SMTP server response timeout. (SM1113)	Continue	Blinking	Keep
16#6108	SMTP authentication error (SM1112)	Continue	Keep	Keep
16#6110	The SMTP server needs to be authenticated. (SM1112)	Continue	Blinking	Keep
16#6111	The specified email address does not exist. (SM1112)	Continue	Blinking	Keep
16#6200	The remote IP address set in the TCP socket function is illegal. (SM1196)	Continue	Blinking	Keep
16#6201	The local communication port set in the TCP socket function is illegal.	Continue	Blinking	Keep
16#6202	The remote communication port set in the TCP socket function is illegal.	Continue	Keep	Keep
16#6203	The device from which the data is sent in the TCP socket function is illegal.	Continue	Keep	Keep
16#6204	The transmitted data length set in the TCP socket function is illegal.	Continue	Keep	Keep
16#6205	The data which is sent through the TCP socket exceeds the device range.	Continue	Keep	Keep
16#6206	The device which receives the data in the TCP socket function is illegal.	Continue	Keep	Keep
16#6207	The received data length set in the TCP socket function is illegal.	Continue	Keep	Keep
16#6208	The data which is received through the TCP socket exceeds the device range.	Continue	Keep	Keep
16#6209	The remote IP address set in the UDP socket function is illegal. (SM1196)	Continue	Keep	Keep
16#620A	The local communication port set in the UDP socket function is illegal.	Continue	Blinking	Keep
16#620B	The remote communication port set in the UDP socket function is illegal.	Continue	Keep	Keep
16#620C	The device from which the data is sent in the UDP socket function is illegal.	Continue	Keep	Keep

Error code	Description	CPU Status	LED indicator status	
			ERROR	BUS FAULT
16#620D	The transmitted data length set in the UDP socket function is illegal.	Continue	Keep	Keep
16#620E	The data which is sent through the UDP socket exceeds the device range.	Continue	Keep	Keep
16#620F	The device which receives the data in the UDP socket function is illegal.	Continue	Keep	Keep
16#6210	The received data length set in the UDP socket function is illegal.	Continue	Keep	Keep
16#6211	The data which is received through the UDP socket exceeds the device range.	Continue	Keep	Keep
16#6212	There is no response from the remote device after the timeout period.	Continue	Keep	Keep
16#6213	The data received exceeds the limit.	Continue	Keep	Keep
16#6214	The remote device refuses the connection.	Continue	Keep	Keep
16#6215	The socket is not opened.	Continue	Keep	Keep
16#6217	The socket is opened.	Continue	Keep	Keep
16#6218	The data has been sent through the socket.	Continue	Keep	Keep
16#6219	The data has been received through the socket.	Continue	Keep	Keep
16#621A	The socket is closed.	Continue	Keep	Keep
16#6300	Only auxiliary relays, data registers, and link registers can be used in the Ether Link.	Continue	Blinking	Keep
16#6301	The device used in the Ether Link exceeds the device range.	Continue	Blinking	Keep
16#6302	The length of the data exchanged in the Ether Link exceeds the limit.	Continue	Blinking	Keep
16#6303	The remote device in the Ether Link aborts the connection.	Continue	Keep	Keep
16#6304	The connection in the Ether Link is busy.	Continue	Keep	Keep
16#6305	The node used in the communication command is different from the local node.	Continue	Blinking	Keep
16#6309	The remote device in the Ether Link does not respond after the timeout period.	Continue	Keep	Keep
16#630A	The module ID or the setting of the module is different from the setting in the Ether Link.	Continue	Blinking	Keep
16#630B	The setting of the netmask address for the CPU or the module is different from the setting in the Ether Link.	Continue	Blinking	Keep
16#6400	The number of TCP connections reaches the upper limit, or the flag which is related to the sending of the data is not set to ON.	Continue	Keep	Keep
16#6401	The remote device aborts the connection.	Continue	Keep	Keep
16#6402	There is no response from the remote device after the timeout period.	Continue	Keep	Keep
16#6403	The remote IP address used in the applied instruction is illegal.	Continue	Keep	Keep
16#6404	The Modbus function code not supported is received.	Continue	Keep	Keep
16#6405	The number of data which will be received is not consistent with the actual length of the data.	Continue	Keep	Keep
16#6500	The initialization of the data exchange fails. (SM699)	Continue	Blinking	OFF

12

Error code	Description	CPU Status	LED indicator status	
			ERROR	BUS FAULT
16#6501	The remote device involved in the data exchange does not respond after the timeout period. (SM828~SM955)	Continue	OFF	OFF
16#6502	The remote device involved in the data exchange does not respond correctly. (SM828~SM955)	Continue	OFF	OFF
16#6700	An error occurs when a Modbus TCP data exchange is initialized.	Continue	Keep	Keep
16#6701	Modbus TCP data exchange timeout	Continue	Keep	Keep
16#6702	The data received by means of a Modbus TCP data exchange is incorrect.	Continue	Keep	Keep
16#7002	The CPU module does not support the function.	Continue	Keep	Keep
16#7203	Invalid access code	Continue	Keep	Keep
16#7401	Function code error	Continue	Keep	Keep
16#7402	The size of a packet exceeds the maximum data length.	Continue	Keep	Keep
16#7404	Packet format error	Continue	Keep	Keep
16#7405	The number of bytes is incorrect.	Continue	Keep	Keep
16#7406	Checksum error	Continue	Keep	Keep
16#7407	There are non-ASCII characters in a command.	Continue	Keep	Keep
16#7408	The PLC is running.	Continue	Keep	Keep
16#740A	Data is being written to the memory in the PLC or data fails to be written to the memory in the PLC.	Continue	Keep	Keep
16#740B	The CPU module is being reset, or the values in the latching devices are being cleared.	Continue	Keep	Keep
16#740E	An error occurs when the the data in the memory in the PLC is cleared.	Continue	Keep	Keep
16#740F	Communication timeout	Continue	Keep	Keep
16#7410	The function code in a reply command is incorrect.	Continue	Keep	Keep
16#7412	Owing to the fact that SW1 is ON, data can not be downloaded to the CPU module.	Continue	Keep	Keep
16#757D	The remaining number of PLC password guesses is 0.	Continue	Keep	Keep
16#757E	The PLC password entered is incorrect.	Continue	Keep	Keep
16#8522	A module configuration is being scanned.	Continue	Keep	Keep
16#853B	An I/O module is not configured.	Continue	Keep	Keep
16#853C	An I/O module does not exist.	Continue	Keep	Keep
16#854B	An I/O module is not configured.	Continue	Keep	Keep
16#854C	An I/O module does not exist.	Continue	Keep	Keep
16#85E2	An I/O interrupt service routine does not exist.	Continue	Keep	Keep
16#9A01	The setting of the data exchange for slave 1 in the PLC Link is incorrect. (SM1590)	Continue	Keep	Keep
16#9A02	The setting of the data exchange for slave 2 in the PLC Link is incorrect. (SM1590)	Continue	Keep	Keep

Error code	Description	CPU Status	LED indicator status	
			ERROR	BUS FAULT
16#9A03	The setting of the data exchange for slave 3 in the PLC Link is incorrect. (SM1590)	Continue	Keep	Keep
16#9A04	The setting of the data exchange for slave 4 in the PLC Link is incorrect. (SM1590)	Continue	Keep	Keep
16#9A05	The setting of the data exchange for slave 5 in the PLC Link is incorrect. (SM1590)	Continue	Keep	Keep
16#9A06	The setting of the data exchange for slave 6 in the PLC Link is incorrect. (SM1590)	Continue	Keep	Keep
16#9A07	The setting of the data exchange for slave 7 in the PLC Link is incorrect. (SM1590)	Continue	Keep	Keep
16#9A08	The setting of the data exchange for slave 8 in the PLC Link is incorrect. (SM1590)	Continue	Keep	Keep
16#9A09	The setting of the data exchange for slave 9 in the PLC Link is incorrect. (SM1590)	Continue	Keep	Keep
16#9A0A	The setting of the data exchange for slave 10 in the PLC Link is incorrect. (SM1590)	Continue	Keep	Keep
16#9A0B	The setting of the data exchange for slave 11 in the PLC Link is incorrect. (SM1590)	Continue	Keep	Keep
16#9A0C	The setting of the data exchange for slave 12 in the PLC Link is incorrect. (SM1590)	Continue	Keep	Keep
16#9A0D	The setting of the data exchange for slave 13 in the PLC Link is incorrect. (SM1590)	Continue	Keep	Keep
16#9A0E	The setting of the data exchange for slave 14 in the PLC Link is incorrect. (SM1590)	Continue	Keep	Keep
16#9A0F	The setting of the data exchange for slave 15 in the PLC Link is incorrect. (SM1590)	Continue	Keep	Keep
16#9A10	The setting of the data exchange for slave 16 in the PLC Link is incorrect. (SM1590)	Continue	Keep	Keep
16#9A11	The setting of the data exchange for slave 17 in the PLC Link is incorrect. (SM1590)	Continue	Keep	Keep
16#9A12	The setting of the data exchange for slave 18 in the PLC Link is incorrect. (SM1590)	Continue	Keep	Keep
16#9A13	The setting of the data exchange for slave 19 in the PLC Link is incorrect. (SM1590)	Continue	Keep	Keep
16#9A14	The setting of the data exchange for slave 20 in the PLC Link is incorrect. (SM1590)	Continue	Keep	Keep
16#9A15	The setting of the data exchange for slave 21 in the PLC Link is incorrect. (SM1590)	Continue	Keep	Keep
16#9A16	The setting of the data exchange for slave 22 in the PLC Link is incorrect. (SM1590)	Continue	Keep	Keep
16#9A17	The setting of the data exchange for slave 23 in the PLC Link is incorrect. (SM1590)	Continue	Keep	Keep
16#9A18	The setting of the data exchange for slave 24 in the PLC Link is incorrect. (SM1590)	Continue	Keep	Keep
16#9A19	The setting of the data exchange for slave 25 in the PLC Link is incorrect. (SM1590)	Continue	Keep	Keep
16#9A1A	The setting of the data exchange for slave 26 in the PLC Link is incorrect. (SM1590)	Continue	Keep	Keep
16#9A1B	The setting of the data exchange for slave 27 in the PLC Link is incorrect. (SM1590)	Continue	Keep	Keep

12

Error code	Description	CPU Status	LED indicator status	
			ERROR	BUS FAULT
16#9A1C	The setting of the data exchange for slave 28 in the PLC Link is incorrect. (SM1590)	Continue	Keep	Keep
16#9A1D	The setting of the data exchange for slave 29 in the PLC Link is incorrect. (SM1590)	Continue	Keep	Keep
16#9A1E	The setting of the data exchange for slave 30 in the PLC Link is incorrect. (SM1590)	Continue	Keep	Keep
16#9A1F	The setting of the data exchange for slave 31 in the PLC Link is incorrect. (SM1590)	Continue	Keep	Keep
16#9A20	The setting of the data exchange for slave 32 in the PLC Link is incorrect. (SM1590)	Continue	Keep	Keep
16#9A21	An error occurs when the master communicates with slave 1 in the PLC Link. (SM SM1591)	Continue	Keep	Keep
16#9A22	An error occurs when the master communicates with slave 2 in the PLC Link. (SM SM1591)	Continue	Keep	Keep
16#9A23	An error occurs when the master communicates with slave 3 in the PLC Link. (SM SM1591)	Continue	Keep	Keep
16#9A24	An error occurs when the master communicates with slave 4 in the PLC Link. (SM SM1591)	Continue	Keep	Keep
16#9A25	An error occurs when the master communicates with slave 5 in the PLC Link. (SM1591)	Continue	Keep	Keep
16#9A26	An error occurs when the master communicates with slave 6 in the PLC Link. (SM1591)	Continue	Keep	Keep
16#9A27	An error occurs when the master communicates with slave 7 in the PLC Link. (SM1591)	Continue	Keep	Keep
16#9A28	An error occurs when the master communicates with slave 8 in the PLC Link. (SM1591)	Continue	Keep	Keep
16#9A29	An error occurs when the master communicates with slave 9 in the PLC Link. (SM1591)	Continue	Keep	Keep
16#9A2A	An error occurs when the master communicates with slave 10 in the PLC Link. (SM1591)	Continue	Keep	Keep
16#9A2B	An error occurs when the master communicates with slave 11 in the PLC Link. (SM1591)	Continue	Keep	Keep
16#9A2C	An error occurs when the master communicates with slave 12 in the PLC Link. (SM1591)	Continue	Keep	Keep
16#9A2D	An error occurs when the master communicates with slave 13 in the PLC Link. (SM1591)	Continue	Keep	Keep
16#9A2E	An error occurs when the master communicates with slave 14 in the PLC Link. (SM1591)	Continue	Keep	Keep
16#9A2F	An error occurs when the master communicates with slave 15 in the PLC Link. (SM1591)	Continue	Keep	Keep
16#9A30	An error occurs when the master communicates with slave 16 in the PLC Link. (SM1591)	Continue	Keep	Keep
16#9A31	An error occurs when the master communicates with slave 17 in the PLC Link. (SM1591)	Continue	Keep	Keep
16#9A32	An error occurs when the master communicates with slave 18 in the PLC Link. (SM1591)	Continue	Keep	Keep
16#9A33	An error occurs when the master communicates with slave 19 in the PLC Link. (SM1591)	Continue	Keep	Keep
16#9A34	An error occurs when the master communicates with slave 20 in the PLC Link. (SM1591)	Continue	Keep	Keep

Error code	Description	CPU Status	LED indicator status	
			ERROR	BUS FAULT
16#9A35	An error occurs when the master communicates with slave 21 in the PLC Link. (SM1591)	Continue	Keep	Keep
16#9A36	An error occurs when the master communicates with slave 22 in the PLC Link. (SM1591)	Continue	Keep	Keep
16#9A37	An error occurs when the master communicates with slave 23 in the PLC Link. (SM1591)	Continue	Keep	Keep
16#9A38	An error occurs when the master communicates with slave 24 in the PLC Link. (SM1591)	Continue	Keep	Keep
16#9A39	An error occurs when the master communicates with slave 25 in the PLC Link. (SM1591)	Continue	Keep	Keep
16#9A3A	An error occurs when the master communicates with slave 26 in the PLC Link. (SM1591)	Continue	Keep	Keep
16#9A3B	An error occurs when the master communicates with slave 27 in the PLC Link. (SM1591)	Continue	Keep	Keep
16#9A3C	An error occurs when the master communicates with slave 28 in the PLC Link. (SM1591)	Continue	Keep	Keep
16#9A3D	An error occurs when the master communicates with slave 29 in the PLC Link. (SM1591)	Continue	Keep	Keep
16#9A3E	An error occurs when the master communicates with slave 30 in the PLC Link. (SM1591)	Continue	Keep	Keep
16#9A3F	An error occurs when the master communicates with slave 31 in the PLC Link. (SM1591)	Continue	Keep	Keep
16#9A40	An error occurs when the master communicates with slave 32 in the PLC Link. (SM1591)	Continue	Keep	Keep
16#9A41	There is no response from slave 1 in the PLC Link. (SM1591)	Continue	Keep	Keep
16#9A42	There is no response from slave 2 in the PLC Link. (SM1591)	Continue	Keep	Keep
16#9A43	There is no response from slave 3 in the PLC Link. (SM1591)	Continue	Keep	Keep
16#9A44	There is no response from slave 4 in the PLC Link. (SM1591)	Continue	Keep	Keep
16#9A45	There is no response from slave 5 in the PLC Link. (SM1591)	Continue	Keep	Keep
16#9A46	There is no response from slave 6 in the PLC Link. (SM1591)	Continue	Keep	Keep
16#9A47	There is no response from slave 7 in the PLC Link. (SM1591)	Continue	Keep	Keep
16#9A48	There is no response from slave 8 in the PLC Link. (SM1591)	Continue	Keep	Keep
16#9A49	There is no response from slave 9 in the PLC Link. (SM1591)	Continue	Keep	Keep
16#9A4A	There is no response from slave 10 in the PLC Link. (SM1591)	Continue	Keep	Keep
16#9A4B	There is no response from slave 11 in the PLC Link. (SM1591)	Continue	Keep	Keep
16#9A4C	There is no response from slave 12 in the PLC Link. (SM1591)	Continue	Keep	Keep
16#9A4D	There is no response from slave 13 in the PLC Link. (SM1591)	Continue	Keep	Keep
16#9A4E	There is no response from slave 14 in the PLC Link. (SM1591)	Continue	Keep	Keep

Error code	Description	CPU Status	LED indicator status	
			ERROR	BUS FAULT
16#9A4F	There is no response from slave 15 in the PLC Link. (SM1591)	Continue	Keep	Keep
16#9A50	There is no response from slave 16 in the PLC Link. (SM1591)	Continue	Keep	Keep
16#9A51	There is no response from slave 17 in the PLC Link. (SM1591)	Continue	Keep	Keep
16#9A52	There is no response from slave 18 in the PLC Link. (SM1591)	Continue	Keep	Keep
16#9A53	There is no response from slave 19 in the PLC Link. (SM1591)	Continue	Keep	Keep
16#9A54	There is no response from slave 20 in the PLC Link. (SM1591)	Continue	Keep	Keep
16#9A55	There is no response from slave 21 in the PLC Link. (SM1591)	Continue	Keep	Keep
16#9A56	There is no response from slave 22 in the PLC Link. (SM1591)	Continue	Keep	Keep
16#9A57	There is no response from slave 23 in the PLC Link. (SM1591)	Continue	Keep	Keep
16#9A58	There is no response from slave 24 in the PLC Link. (SM1591)	Continue	Keep	Keep
16#9A59	There is no response from slave 25 in the PLC Link. (SM1591)	Continue	Keep	Keep
16#9A5A	There is no response from slave 26 in the PLC Link. (SM1591)	Continue	Keep	Keep
16#9A5B	There is no response from slave 27 in the PLC Link. (SM1591)	Continue	Keep	Keep
16#9A5C	There is no response from slave 28 in the PLC Link. (SM1591)	Continue	Keep	Keep
16#9A5D	There is no response from slave 29 in the PLC Link. (SM1591)	Continue	Keep	Keep
16#9A5E	There is no response from slave 30 in the PLC Link. (SM1591)	Continue	Keep	Keep
16#9A5F	There is no response from slave 31 in the PLC Link. (SM1591)	Continue	Keep	Keep
16#9A60	There is no response from slave 32 in the PLC Link. (SM1591)	Continue	Keep	Keep
16#9A61	The setting of the PLC Link mode is incorrect. (SM1589)	Continue	Keep	Keep
16#9A62	The number of polling cycles in the PLC Link is incorrect. (SM1591)	Continue	Keep	Keep
16#9A63	There is a handshaking timeout when the CPU module establishes a connection with the network module. (SM1596)	Continue	Keep	Keep
16#9A64	There is no network module parameter in the CPU module. (SM1596)	Continue	Keep	Keep
16#9B01	An error occurs when the connection between COM2 and MODBUS is being initialized.	Continue	Keep	Keep
16#9B21	An error occurs when COM2 communicates with slave 1 by Modbus.	Continue	Keep	Keep
16#9B22	An error occurs when COM2 communicates with slave 2 by Modbus.	Continue	Keep	Keep
16#9B23	An error occurs when COM2 communicates with slave 3 by Modbus.	Continue	Keep	Keep
16#9B24	An error occurs when COM2 communicates with slave 4 by Modbus.	Continue	Keep	Keep
16#9B25	An error occurs when COM2 communicates with slave 5 by Modbus.	Continue	Keep	Keep
16#9B26	An error occurs when COM2 communicates with slave 6 by Modbus.	Continue	Keep	Keep

Error code	Description	CPU Status	LED indicator status	
			ERROR	BUS FAULT
16#9B27	An error occurs when COM2 communicates with slave 7 by Modbus.	Continue	Keep	Keep
16#9B28	An error occurs when COM2 communicates with slave 8 by Modbus.	Continue	Keep	Keep
16#9B29	An error occurs when COM2 communicates with slave 9 by Modbus.	Continue	Keep	Keep
16#9B2A	An error occurs when COM2 communicates with slave 10 by Modbus.	Continue	Keep	Keep
16#9B2B	An error occurs when COM2 communicates with slave 11 by Modbus.	Continue	Keep	Keep
16#9B2C	An error occurs when COM2 communicates with slave 12 by Modbus.	Continue	Keep	Keep
16#9B2D	An error occurs when COM2 communicates with slave 13 by Modbus.	Continue	Keep	Keep
16#9B2E	An error occurs when COM2 communicates with slave 14 by Modbus.	Continue	Keep	Keep
16#9B2F	An error occurs when COM2 communicates with slave 15 by Modbus.	Continue	Keep	Keep
16#9B30	An error occurs when COM2 communicates with slave 16 by Modbus.	Continue	Keep	Keep
16#9B31	An error occurs when COM2 communicates with slave 17 by Modbus.	Continue	Keep	Keep
16#9B32	An error occurs when COM2 communicates with slave 18 by Modbus.	Continue	Keep	Keep
16#9B33	An error occurs when COM2 communicates with slave 19 by Modbus.	Continue	Keep	Keep
16#9B34	An error occurs when COM2 communicates with slave 20 by Modbus.	Continue	Keep	Keep
16#9B35	An error occurs when COM2 communicates with slave 21 by Modbus.	Continue	Keep	Keep
16#9B36	An error occurs when COM2 communicates with slave 22 by Modbus.	Continue	Keep	Keep
16#9B37	An error occurs when COM2 communicates with slave 23 by Modbus.	Continue	Keep	Keep
16#9B38	An error occurs when COM2 communicates with slave 24 by Modbus.	Continue	Keep	Keep
16#9B39	An error occurs when COM2 communicates with slave 25 by Modbus.	Continue	Keep	Keep
16#9B3A	An error occurs when COM2 communicates with slave 26 by Modbus.	Continue	Keep	Keep
16#9B3B	An error occurs when COM2 communicates with slave 27 by Modbus.	Continue	Keep	Keep
16#9B3C	An error occurs when COM2 communicates with slave 28 by Modbus.	Continue	Keep	Keep
16#9B3D	An error occurs when COM2 communicates with slave 29 by Modbus.	Continue	Keep	Keep
16#9B3E	An error occurs when COM2 communicates with slave 30 by Modbus.	Continue	Keep	Keep
16#9B3F	An error occurs when COM2 communicates with slave 31 by Modbus.	Continue	Keep	Keep
16#9B40	An error occurs when COM2 communicates with slave 32 by Modbus.	Continue	Keep	Keep
16#9B41	COM2 receives no response from slave 1 by Modbus.	Continue	Keep	Keep
16#9B42	COM2 receives no response from slave 2 by Modbus.	Continue	Keep	Keep
16#9B43	COM2 receives no response from slave 3 by Modbus.	Continue	Keep	Keep
16#9B44	COM2 receives no response from slave 4 by Modbus.	Continue	Keep	Keep

12

Error code	Description	CPU Status	LED indicator status	
			ERROR	BUS FAULT
16#9B45	COM2 receives no response from slave 5 by Modbus.	Continue	Keep	Keep
16#9B46	COM2 receives no response from slave 6 by Modbus.	Continue	Keep	Keep
16#9B47	COM2 receives no response from slave 7 by Modbus.	Continue	Keep	Keep
16#9B48	COM2 receives no response from slave 8 by Modbus.	Continue	Keep	Keep
16#9B49	COM2 receives no response from slave 9 by Modbus.	Continue	Keep	Keep
16#9B4A	COM2 receives no response from slave 10 by Modbus.	Continue	Keep	Keep
16#9B4B	COM2 receives no response from slave 11 by Modbus.	Continue	Keep	Keep
16#9B4C	COM2 receives no response from slave 12 by Modbus.	Continue	Keep	Keep
16#9B4D	COM2 receives no response from slave 13 by Modbus.	Continue	Keep	Keep
16#9B4E	COM2 receives no response from slave 14 by Modbus.	Continue	Keep	Keep
16#9B4F	COM2 receives no response from slave 15 by Modbus.	Continue	Keep	Keep
16#9B50	COM2 receives no response from slave 16 by Modbus.	Continue	Keep	Keep
16#9B51	COM2 receives no response from slave 17 by Modbus.	Continue	Keep	Keep
16#9B52	COM2 receives no response from slave 18 by Modbus.	Continue	Keep	Keep
16#9B53	COM2 receives no response from slave 19 by Modbus.	Continue	Keep	Keep
16#9B54	COM2 receives no response from slave 20 by Modbus.	Continue	Keep	Keep
16#9B55	COM2 receives no response from slave 21 by Modbus.	Continue	Keep	Keep
16#9B56	COM2 receives no response from slave 22 by Modbus.	Continue	Keep	Keep
16#9B57	COM2 receives no response from slave 23 by Modbus.	Continue	Keep	Keep
16#9B58	COM2 receives no response from slave 24 by Modbus.	Continue	Keep	Keep
16#9B59	COM2 receives no response from slave 25 by Modbus.	Continue	Keep	Keep
16#9B5A	COM2 receives no response from slave 26 by Modbus.	Continue	Keep	Keep
16#9B5B	COM2 receives no response from slave 27 by Modbus.	Continue	Keep	Keep
16#9B5C	COM2 receives no response from slave 28 by Modbus.	Continue	Keep	Keep
16#9B5D	COM2 receives no response from slave 29 by Modbus.	Continue	Keep	Keep
16#9B5E	COM2 receives no response from slave 30 by Modbus.	Continue	Keep	Keep
16#9B5F	COM2 receives no response from slave 31 by Modbus.	Continue	Keep	Keep
16#9B60	COM2 receives no response from slave 32 by Modbus.	Continue	Keep	Keep

12.4.2 Analog I/O Modules and Temperature Measurement Modules

Error code	Description	LED indicator status	
		CPU	Module
		BUS FAULT	ERROR
16#A000	The signal received by channel 0 exceeds the range of inputs which can be received by the hardware.	Blinking	
16#A001	The signal received by channel 1 exceeds the range of inputs which can be received by the hardware.	Blinking	
16#A002	The signal received by channel 2 exceeds the range of inputs which can be received by the hardware.	Blinking	
16#A003	The signal received by channel 3 exceeds the range of inputs which can be received by the hardware.	Blinking	
16#A004	The signal received by channel 4 exceeds the range of inputs which can be received by the hardware.	Blinking	
16#A005	The signal received by channel 5 exceeds the range of inputs which can be received by the hardware.	Blinking	
16#A006	The signal received by channel 6 exceeds the range of inputs which can be received by the hardware.	Blinking	
16#A007	The signal received by channel 7 exceeds the range of inputs which can be received by the hardware.	Blinking	
16#A400	The signal received by channel 0 exceeds the range of inputs which can be received by the hardware.	ON	
16#A401	The signal received by channel 1 exceeds the range of inputs which can be received by the hardware.	ON	
16#A402	The signal received by channel 2 exceeds the range of inputs which can be received by the hardware.	ON	
16#A403	The signal received by channel 3 exceeds the range of inputs which can be received by the hardware.	ON	
16#A404	The signal received by channel 4 exceeds the range of inputs which can be received by the hardware.	ON	
16#A405	The signal received by channel 5 exceeds the range of inputs which can be received by the hardware.	ON	
16#A406	The signal received by channel 6 exceeds the range of inputs which can be received by the hardware.	ON	
16#A407	The signal received by channel 7 exceeds the range of inputs which can be received by the hardware.	ON	
16#A600	Hardware failure	ON	
16#A601	The external voltage is abnormal.	ON	
16#A602	Internal error The CJC is abnormal.	ON	
16#A603	Internal error The factory correction is abnormal.	ON	
16#A800	The signal received by channel 0 exceeds the range of inputs which can be received by the hardware.	OFF	
16#A801	The signal received by channel 1 exceeds the range of inputs which can be received by the hardware.	OFF	
16#A802	The signal received by channel 2 exceeds the range of inputs which can be received by the hardware.	OFF	
16#A803	The signal received by channel 3 exceeds the range of inputs which can be received by the hardware.	OFF	
16#A804	The signal received by channel 4 exceeds the range of inputs which can be received by the hardware.	OFF	
16#A805	The signal received by channel 5 exceeds the range of inputs which can be received by the hardware.	OFF	

Error code	Description	LED indicator status	
		CPU	Module
		BUS FAULT	ERROR
16#A806	The signal received by channel 6 exceeds the range of inputs which can be received by the hardware.	OFF	
16#A807	The signal received by channel 7 exceeds the range of inputs which can be received by the hardware.	OFF	

*With regard to the errors related to the input signals' exceeding the range of inputs which can be received by the hardware and the conversion values' exceeding the limits, whether the error code generated is in the range of 16#A000 to 16#A00F, in the range of 16#A400 to 16#A40F, or in the range of 16#A800 to 16#A80F depends on the LED indicator status defined by users.

12.4.3 AH02HC-5A/AH04HC-5A

Error code	Description	LED indicator status	
		CPU	Module
		BUS FAULT	ERROR
16#A001	The linear accumulation in channel 0 exceeds the range.	Blinking	
16#A002	The scale set for channel 0 exceeds the range.	Blinking	
16#A003	The number of cycles set for channel 0 exceeds the range.	Blinking	
16#A004	The comparison value set for channel 0 exceeds the range.	Blinking	
16#A005	A limit value set for channel 0 is incorrect.	Blinking	
16#A006	The interrupt number set for channel 0 exceeds the range.	Blinking	
16#A011	The linear accumulation in channel 1 exceeds the range.	Blinking	
16#A012	The scale set for channel 1 exceeds the range.	Blinking	
16#A013	The number of cycles set for channel 1 exceeds the range.	Blinking	
16#A014	The comparison value set for channel 1 exceeds the range.	Blinking	
16#A015	A limit value set for channel 1 is incorrect.	Blinking	
16#A016	The interrupt number set for channel 1 exceeds the range.	Blinking	
16#A021	The linear accumulation in channel 2 exceeds the range.	Blinking	
16#A022	The scale set for channel 2 exceeds the range.	Blinking	
16#A023	The number of cycles set for channel 2 exceeds the range.	Blinking	
16#A024	The comparison value set for channel 2 exceeds the range.	Blinking	
16#A025	A limit value set for channel 2 is incorrect.	Blinking	
16#A026	The interrupt number set for channel 2 exceeds the range.	Blinking	
16#A031	The linear accumulation in channel 3 exceeds the range.	Blinking	
16#A032	The scale set for channel 3 exceeds the range.	Blinking	
16#A033	The number of cycles set for channel 3 exceeds the range.	Blinking	
16#A034	The comparison value set for channel 3 exceeds the range.	Blinking	
16#A035	A limit value set for channel 3 is incorrect.	Blinking	
16#A036	The interrupt number set for channel 3 exceeds the range.	Blinking	

12.4.4 AH05PM-5A/AH10PM-5A/AH15PM-5A

Error code	Description	LED indicator status	
		CPU	Module
		BUS FAULT	ERROR
16#A002	The subroutine has no data.	Blinking	
16#A003	CJ, CJN, and JMP have no matching pointers.	Blinking	
16#A004	There is a subroutine pointer in the main program.	Blinking	
16#A005	Lack of the subroutine	Blinking	
16#A006	The pointer is used repeatedly in the same program.	Blinking	
16#A007	The subroutine pointer is used repeatedly.	Blinking	

Error code	Description	LED indicator status	
		CPU	Module
		BUS FAULT	ERROR
16#A008	The pointer used in JMP is used repeatedly in different subroutines.	Blinking	
16#A009	The pointer used in JMP is the same as the pointer used in CALL.	Blinking	
16#A00A	The pointer used in JMP is the same as a subroutine pointer.	Blinking	
16#A00B	Target position (I) of the single speed is incorrect.	Blinking	
16#A00C	Target position (II) of the single-axis motion is incorrect.	Blinking	
16#A00D	The setting of speed (I) of the single-axis motion is incorrect.	Blinking	
16#A00E	The setting of speed (II) of the single-axis motion is incorrect.	Blinking	
16#A00F	The setting of the speed (V_{RT}) of returning to zero is incorrect.	Blinking	
16#A010	The setting of the deceleration (V_{CR}) of returning to zero is incorrect.	Blinking	
16#A011	The setting of the JOG speed is incorrect.	Blinking	
16#A012	The positive pulses generated by the single-axis clockwise motion are inhibited.	Blinking	
16#A013	The negative pulses generated by the single-axis counterclockwise motion are inhibited.	Blinking	
16#A014	The limit switch is reached.	Blinking	
16#A015	The device which is used exceeds the device range.	Blinking	
16#A017	An error occurs when the device is modified by a 16-bit index register/32-bit index register.	Blinking	
16#A018	The conversion into the floating-point number is incorrect.	Blinking	
16#A019	The conversion into the binary-coded decimal number is incorrect.	Blinking	
16#A01A	Incorrect division operation (The divisor is 0.)	Blinking	
16#A01B	General program error	Blinking	
16#A01C	LD/LDI has been used more than nine times.	Blinking	
16#A01D	There is more than one level of nested program structure supported by RPT/RPE.	Blinking	
16#A01E	SRET is used between RPT and RPE.	Blinking	
16#A01F	There is no M102 in the main program, or there is no M2 in the motion program.	Blinking	
16#A020	The wrong instruction is used, or the device used exceeds the range.	Blinking	

12.4.5 AH20MC-5A

Error code	Description	LED indicator status	
		CPU	Module
		BUS FAULT	ERROR
16#A002	The subroutine has no data.	Blinking	
16#A003	CJ, CJN, and JMP have no matching pointers.	Blinking	
16#A004	There is a subroutine pointer in the main program.	Blinking	
16#A005	Lack of the subroutine	Blinking	
16#A006	The pointer is used repeatedly in the same program.	Blinking	
16#A007	The subroutine pointer is used repeatedly.	Blinking	
16#A008	The pointer used in JMP is used repeatedly in different subroutines.	Blinking	
16#A009	The pointer used in JMP is the same as the pointer used in CALL.	Blinking	
16#A00A	The pointer used in JMP is the same as a subroutine pointer.	Blinking	

Error code	Description	LED indicator status	
		CPU	Module
		BUS FAULT	ERROR
16#A00B	Target position (I) of the single speed is incorrect.	Blinking	
16#A00C	Target position (II) of the single-axis motion is incorrect.	Blinking	
16#A00D	The setting of speed (I) of the single-axis motion is incorrect.	Blinking	
16#A00E	The setting of speed (II) of the single-axis motion is incorrect.	Blinking	
16#A00F	The setting of the speed (V_{RT}) of returning to zero is incorrect.	Blinking	
16#A010	The setting of the deceleration (V_{CR}) of returning to zero is incorrect.	Blinking	
16#A011	The setting of the JOG speed is incorrect.	Blinking	
16#A012	The positive pulses generated by the single-axis clockwise motion are inhibited.	Blinking	
16#A013	The negative pulses generated by the single-axis counterclockwise motion are inhibited.	Blinking	
16#A014	The limit switch is reached.	Blinking	
16#A015	The device which is used exceeds the device range.	Blinking	
16#A017	An error occurs when the device is modified by a 16-bit index register/32-bit index register.	Blinking	
16#A018	The conversion into the floating-point number is incorrect.	Blinking	
16#A019	The conversion into the binary-coded decimal number is incorrect.	Blinking	
16#A01A	Incorrect division operation (The divisor is 0.)	Blinking	
16#A01B	General program error	Blinking	
16#A01C	LD/LDI has been used more than nine times.	Blinking	
16#A01D	There is more than one level of nested program structure supported by RPT/RPE.	Blinking	
16#A01E	SRET is used between RPT and RPE.	Blinking	
16#A01F	Incorrect division operation (The divisor is 0.)	Blinking	
16#A020	The wrong instruction is used, or the device used exceeds the range.	Blinking	

12.4.6 AH10EN-5A

Error code	Description	LED indicator status	
		CPU	Module
		BUS FAULT	ERROR
16#A001	The IP address of host 1 conflicts with another system on the network.	Blinking	
16#A002	The IP address of host 2 conflicts with another system on the network.	Blinking	
16#A003	DHCP for host 1 fails.	Blinking	
16#A004	DHCP for host 2 fails.	Blinking	
16#A401	Hardware error	ON	
16#A402	The initialization of the system fails.	ON	

12.4.7 AH10SCM-5A/AH15SCM-5A

Error code	Description	LED indicator status	
		CPU	Module
		BUS FAULT	ERROR
16#A002	The setting of the UD Link is incorrect, or the communication fails.	Blinking	
16#A401	Hardware error	ON	
16#A804	The communication through the communication port is incorrect.	OFF	
16#A808	Modbus communication error	OFF	

12

12.4.8 AH10DNET-5A

Error code	Description	LED indicator status		
		CPU	Module	
		BUS FAULT	MS	NS
16#A0F0	The node ID of AH10DNET-5A is the same as other node ID on the network, or exceeds the range.	The red light blinks.	The green light blinks.	The red light is ON.
16#A0F1	No slave is put in the scan list of AH10DNET-5A.	The red light blinks.	The green light blinks.	The green light is ON.
16#A0F2	The working voltage of AH10DNET-5A is low.	The red light blinks.	The red light blinks.	The red light blinks.
16#A0F3	AH10DNET-5A enters the test mode.	The red light blinks.	The orange light is ON.	The orange light is ON.
16#A0F4	The bus of AH10DNET-5A is switched OFF.	The red light blinks.	The green light is ON.	The red light is ON.
16#A0F5	AH10DNET-5A detects that there is no network power supply to the DeviceNet.	The red light blinks.	The red light blinks.	The red light is ON.
16#A0F6	Something is wrong with the internal memory of AH10DNET-5A.	The red light blinks.	The red light is ON.	The green light blinks.
16#A0F7	Something is wrong with the data exchange unit of AH10DNET-5A.	The red light blinks.	The red light is ON.	The green light blinks.
16#A0F8	The product ID of AH10DNET-5A is incorrect.	The red light blinks.	The red light is ON.	The green light blinks.
16#A0F9	An error occurs when the data is read from AH10DNET-5A, or when the data is written into AH10DNET-5A.	The red light blinks.	The red light is ON.	The red light is ON.
16#A0FA	The node ID of AH10DNET-5A is the same as that of the slave set in the scan list.	The red light blinks.	The green light is ON.	The red light is ON.
16#A0FB	The data exchange between AH10DNET and AH CPU failed.	The red light blinks.	The green light is ON.	The green light is ON.
16#A0FC	Errors occur in the slaves, on the module of an AHRTU-DNET backplane, or on the AHRTU-DNET backplane connection.	The red light blinks.	The red light blinks.	The green light is ON.

12

12.4.9 AH10PFBM-5A

Error code	Description	LED indicator status			
		CPU	Module		
		BUS FAULT	RUN	SYS	DP
16#A001	The master is not set.	The red light blinks.	The green light is ON.	The green light is ON.	The green light blinks.
16#A003	The master station enters the test mode.	The red light blinks.	The green light is ON.	The green light is ON.	The green light is ON.
16#A005	A timeout occurs when chips inside the master station communicate.	The red light blinks.	The green light is ON.	The green light is ON.	The green light is ON.
16#A00B	A timeout occurs when AH10PFBM-5A exchanges data exchange with a PLC.	The red light blinks.	The green light is ON.	The green light is ON.	The green light is ON.
16#A402	The PLC does not assign the I/O mapping area to the master.	The red light is ON.	The green light is ON.	The green light is ON.	The green light is ON.
16#A404	Master initializing error	The red light is ON.	The green light is ON.	The green light is ON.	The green light is ON.
16#A406	Internal storage unit error	The red light is ON.	The green light is ON.	The green light is ON.	The green light is ON.
16#A407	Data exchange unit error	The red light is ON.	The green light is ON.	The green light is ON.	The green light is ON.
16#A408	Master serial number detection error	The red light is ON.	The green light is ON.	The green light is ON.	The green light is ON.
16#A4E2	The master detects that all the slaves are offline.	The red light is ON.	OFF	The green light is ON.	The red light is ON.
	The master detects that some slaves are offline.	The red light is ON.	OFF	The green light is ON.	The red light blinks.
16#A4E6	The master detects that an error occurs in the module connected to AHRTU-PFBS-5A.	The red light is ON.	The green light is ON.	The green light is ON.	The green light is ON.

12.4.10 AH10PFBS-5A

Error code	Description	LED indicator status		
		CPU	Module	
		BUS FAULT	RUN	NET
16#A4F0	The node address of AH10PFBS-5A exceeds the valid range.	The red light is ON.	The green light is ON.	The green light is ON.
16#A4F1	Internal hardware error	The red light is ON.	The green light is ON.	The green light is ON.
16#A4F2	Parameter error	The red light is ON.	The green light is ON.	The green light is ON.
16#A4F3	Configuration error	The red light is ON.	The green light is ON.	The green light is ON.
16#A4F4	GPIO detection error	The red light is ON.	The green light is ON.	The green light is ON.
16#A4F5	AH10PFBS-5A enters the mode of factory test.	The red light is ON.	The green light is ON.	The green light is ON.
16#A4F6	1. AH10PFBS-5A has not been connected to the PROFIBUS-DP network. 2. PROFIBUS-DP master has not configured AH10PFBS-5A slave or	The red light is ON.	The green light is ON.	The red light is ON.

Error code	Description	LED indicator status		
		CPU		Module
		BUS FAULT	RUN	NET
	the configured node address of AH10PFBS-5A is inconsistent with that of the actually connected one.			

12.4.11 AH10COPM-5A

Error code	Description	LED indicator status	
		CPU	Module
		BUS FAULT	ERROR
16#A0B0	AH10COPM-5A does not send a heartbeat message after a set period of time.	Blinking	The red light flashes twice.
16#A0B1	The length of a PDO that a slave station sends is not the same as the length of the PDO set in the node list.	Blinking	OFF
16#A0B2	The master station selected does not send a node guarding message after a set period of time.	Blinking	The red light flashes twice.
16#A0E0	AH10COPM-5A receives an emergency message from a slave station.	Blinking	OFF
16#A0E1	The length of a PDO that a slave station sends is not the same as the length of the PDO set in the node list.	Blinking	OFF
16#A0E2	AH10COPM-5A does not receive a PDO from a slave station.	Blinking	OFF
16#A0E3	An automatic SDO is not downloaded successfully.	Blinking	OFF
16#A0E4	A PDO parameter is not set successfully.	Blinking	OFF
16#A0E5	A key parameter is set incorrectly.	Blinking	OFF
16#A0E6	The actual network configuration is not the same as the network configuration set.	Blinking	OFF
16#A0E7	The control of the errors in a slave station is not sent after a set period of time.	Blinking	The red light flashes twice.
16#A0E8	The master station address is the same as a slave station address.	Blinking	OFF
16#A0F1	No slave station is added to the node list in CANopen builder.	Blinking	OFF
16#A0F3	An error occurs in AH10COPM-5A.	Blinking	OFF
16#A0F4	The bus used is off.	Blinking	The red light is ON.
16#A0F5	The node address of AH10COPM-5A is set incorrectly.	Blinking	OFF
16#A0F6	Internal error: An error occurs in the manufacturing process in the factory.	Blinking	OFF
16#A0F7	Internal error: GPIO error	Blinking	OFF
16#A0F8	Hardware error	Blinking	OFF
16#A0F9	Low voltage	Blinking	OFF
16#A0FA	An error occurs in the firmware of AH10COPM-5A.	Blinking	OFF
16#A0FB	The transmission registers in AH10COPM-5A are full.	Blinking	OFF
16#A0FC	The reception registers in AH10COPM-5A are full.	Blinking	OFF

MEMO

12

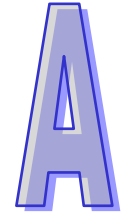

Appendix A Installing a USB Driver

Table of Contents

A.1 Installing the USB Driver for an AH500 Series CPU module in Windows XP with SP3	A-2
A.2 Installing the USB Driver for an AH500 Series CPU module in Windows 7.....	A-6
A.3 Installing the USB Driver for an AH500 Series CPU module in Windows 8.....	A-10
A.4 Installing the USB Driver for an AH500 Series CPU module in Windows 10.....	A-13

A.1 Installing the USB Driver for an AH500 Series CPU module in Windows XP with SP3

The installation of the USB driver for an AH500 series CPU module on Windows XP is introduced below. If users want to install the USB driver for an AH500 series CPU module on another operating system, they have to refer to the instructions in the operating system for more information about the installation of new hardware.

- (1) Make sure that the AH500 series CPU module is supplied with power normally. Connect the AH500 series CPU module to a USB port on the computer with a USB cable. Select the **No, not this time** option button in the **Found New Hardware Wizard** window, and then click **Next**.

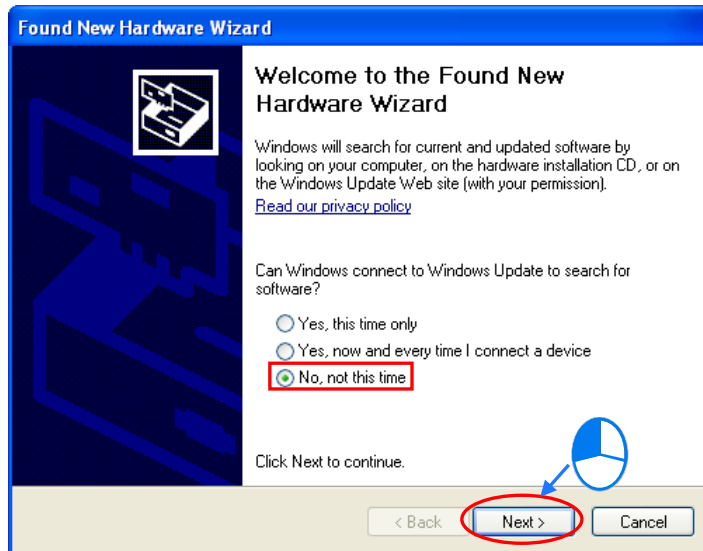

- (2) The name of the USB device detected is displayed in the window. Please select the **Install from a lost or specific location (Advanced)** option button.

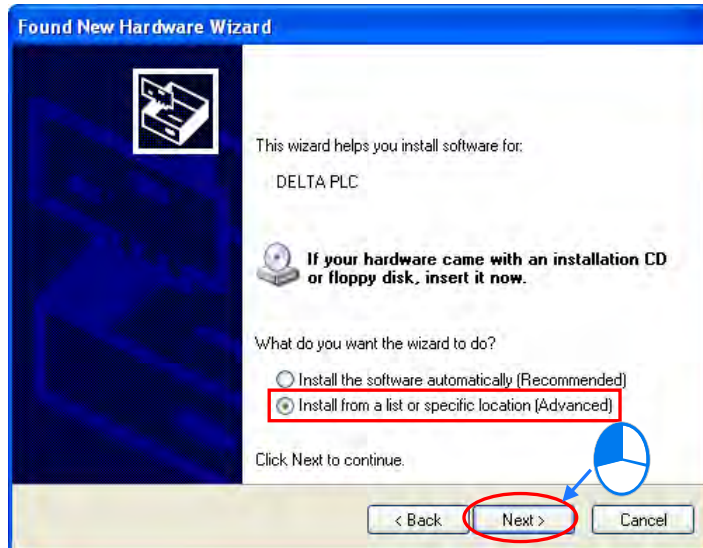

- (3) After ISPSOft version 2.00 or above is installed, the driver for the AH500 series CPU module will be in the folder denoted by the path **Installation path of ISPSOft \drivers\Delta_PLC_USB_Driver**. Specify the correct path. If the driver for the AH500 series CPU module is gotten in another way, users have to specify the corresponding path. Click **Next** to carry on the installation.

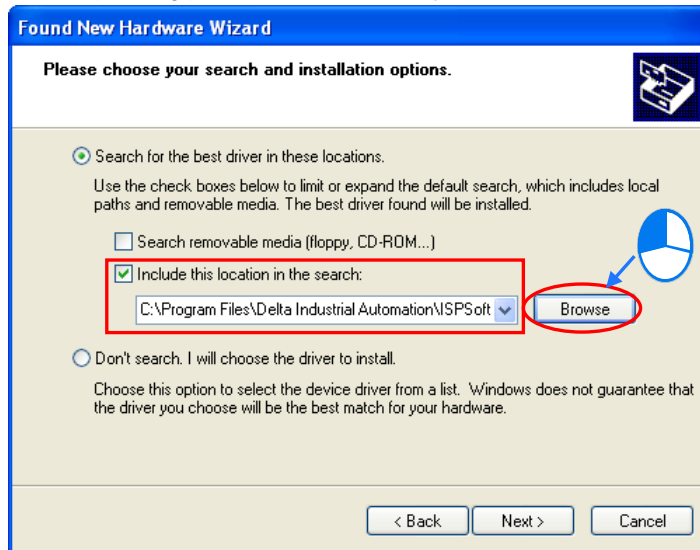

- (4) After the correct driver is found in the folder denoted by the path, the system will install the driver. If the **Hardware Installation** window appears during the installation, please click **Continue Anyway**.

A



- (5) Click **Finish** after the installation is finished.

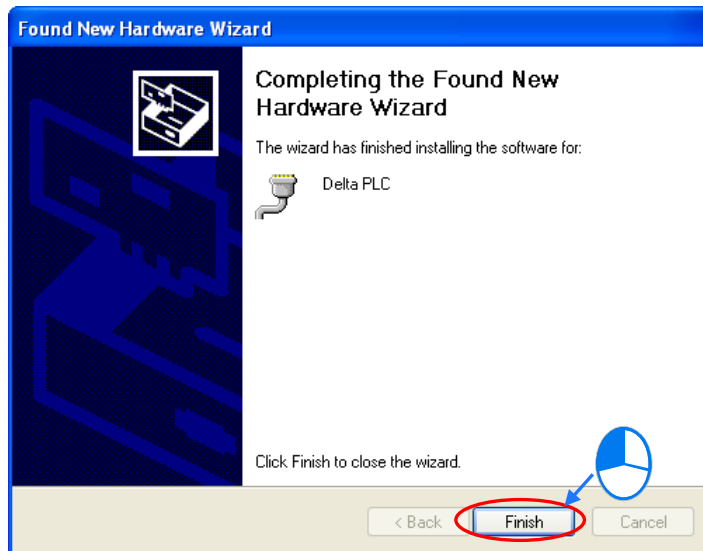

- (6) Open the **Device Manager** window after the installation is finished. If the name of the USB device connected is under **Ports (COM&LPT)**, the installation of the driver is successful. The operating system assigns a communication port number to the USB device.

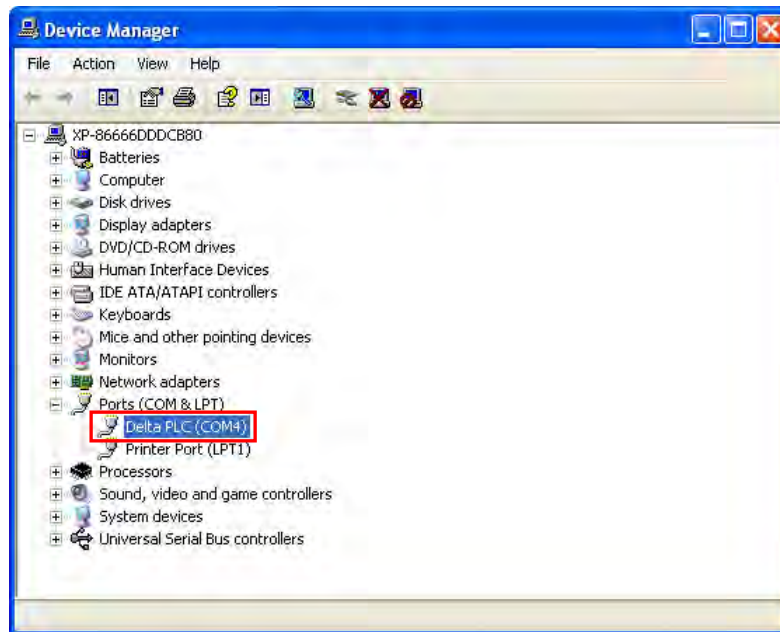

A

Additional remark

- If the PLC is connected to another USB port on the computer, the system may ask users to install the driver again. The users can follow the steps above, and install the driver again. After the driver is installed, the communication port number that the operating system assigns to the USB device may be different.
- If Windows XP SP3 has not been installed on the computer, an error message will appear during the installation. Users can deal with the problem in either way below.
 - (a) Cancel the installation, install Windows XP SP3, and reinstall the driver according to the steps above.
 - (b) Get the file needed, and specify the path pointing to the file in the **Files Needed** window.

A.2 Installing the USB Driver for an AH500 Series CPU module in Windows 7

The installation of the USB driver for an AH series CPU module on Windows 7 is introduced below. If users want to install the USB driver for an AH series CPU module on another operating system, they have to refer to the instructions in the operating system for more information about the installation of new hardware.

- Make sure that the AH series CPU module is supplied with power normally. Connect the AH series CPU module to a USB port on the computer with a USB cable.
- The name of the USB device detected will be displayed in the Control Panel > Device Manager window. Please select and double-click DELTA PLC.

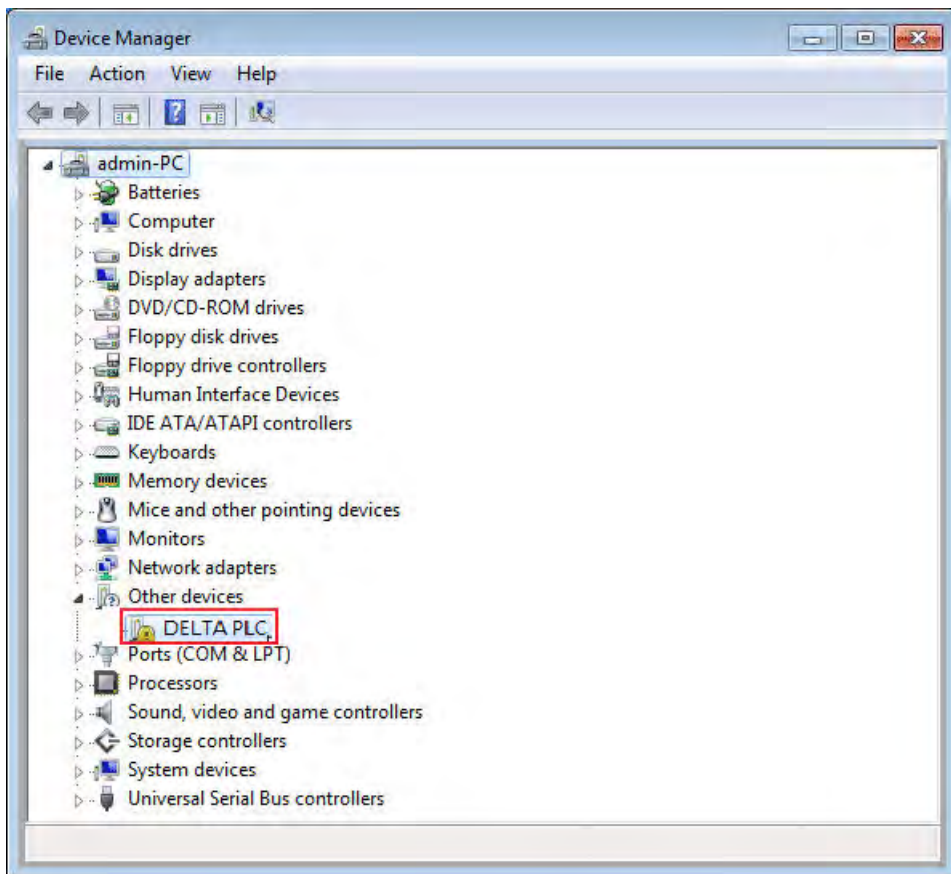

- Click **Update Driver....** in the **DELTA PLC Properties** window.

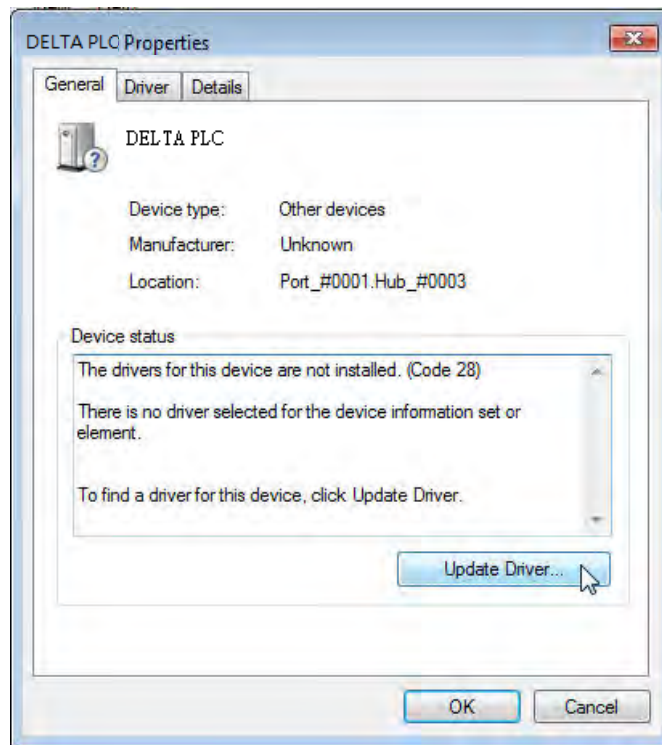

- Click **Browse my computer for driver software.**

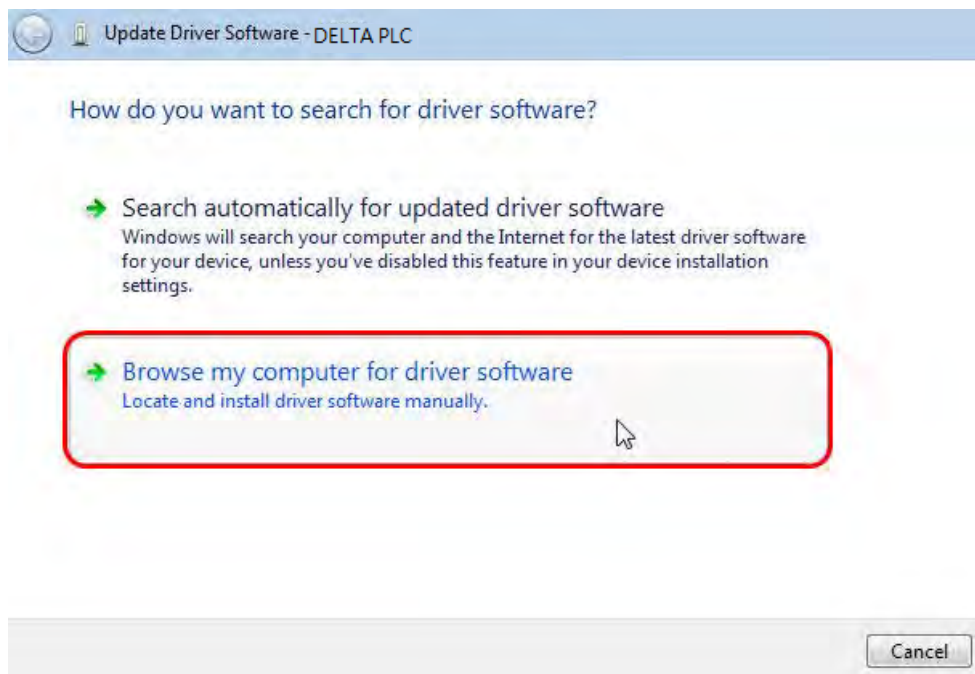

- After ISPSOft version 3.00 or above is installed, the driver for the AH series CPU module will be in the folder denoted by the path Installation path of **ISPSOft \drivers\Delta_PLC_USB_Driver**.
- Specify the correct path. If the driver for the AH series CPU module is gotten in another way, users have to specify the corresponding path. Click **Next** to carry on the installation.

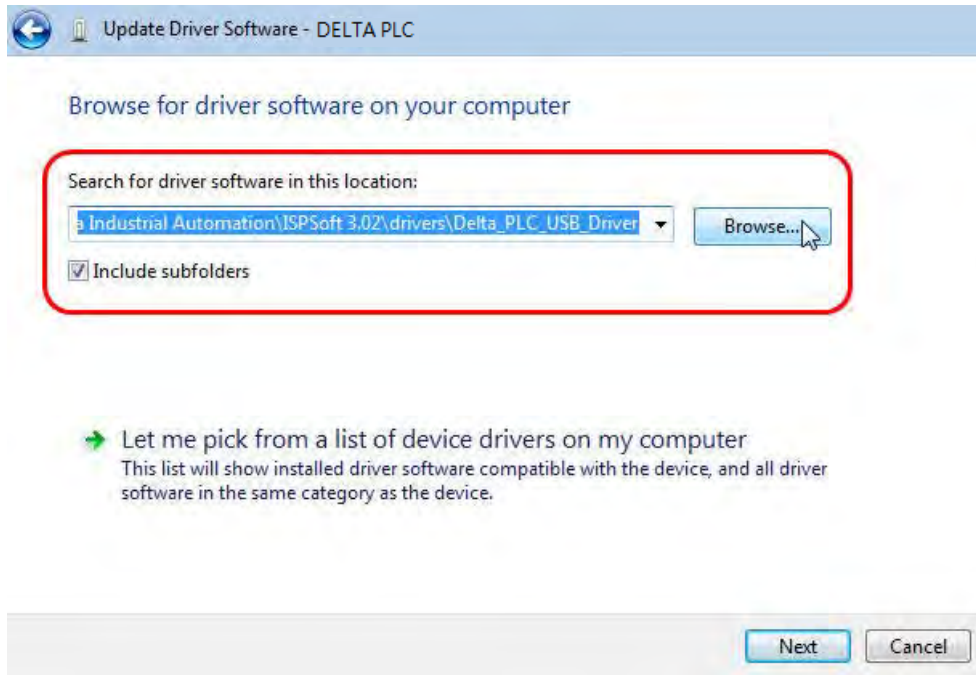

A

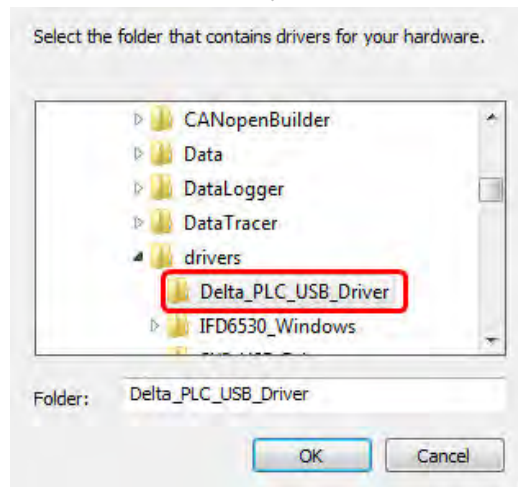

- After the correct driver is found in the folder denoted by the path, the system will install the driver. If the **Windows Security** window appears during the installation, please click **Install this driver software anyway**.



A

- Click **Close** after the installation is finished.

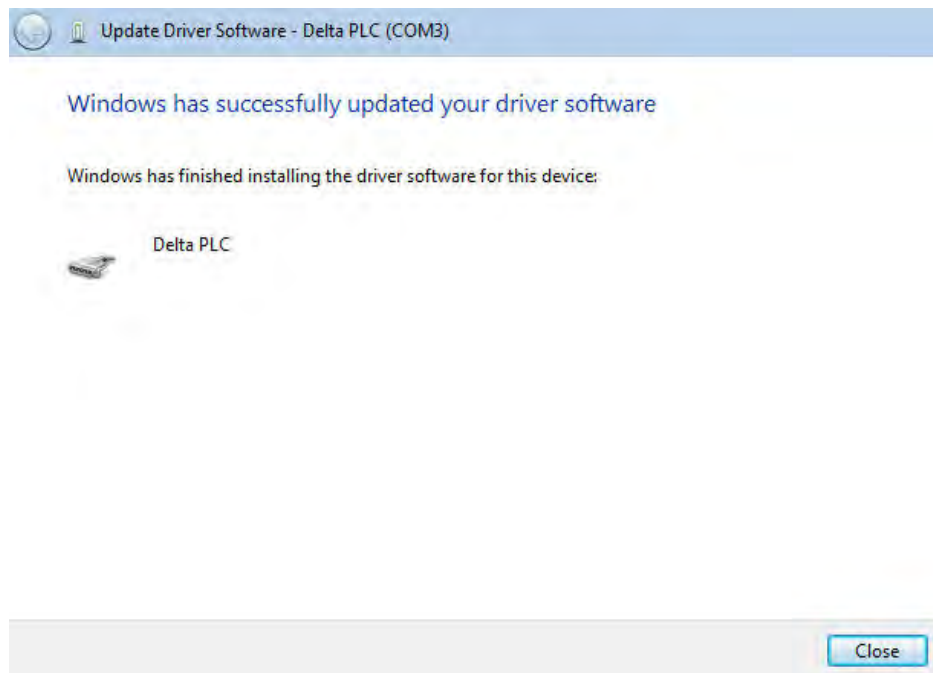

- Open the **Device Manager** window after the installation is finished. If the name of the USB device connected is under **Ports (COM&LPT)**, the installation of the driver is successful. The operating system assigns a communication port number to the USB device.

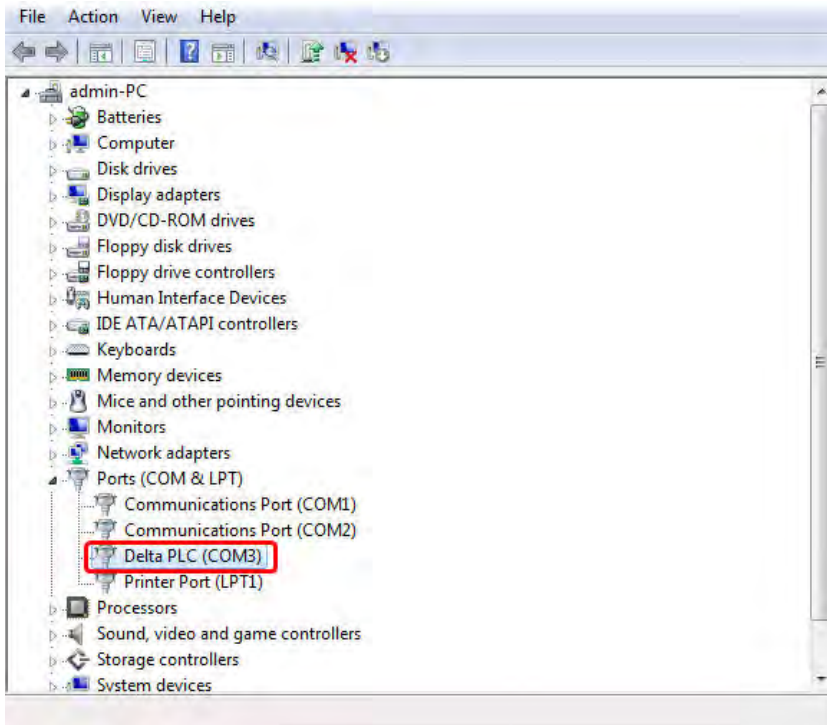

Additional remark

- If the PLC is connected to another USB port on the computer, the system may ask users to install the driver again. The users can follow the steps above, and install the driver again. After the driver is installed, the communication port number that the operating system assigns to the USB device may be different.

A.3 Installing the USB Driver for an AH500 Series CPU module in Windows 8

Windows 8 driver signature enforcement provides a way to improve the security of the operating system by validating the integrity of a driver or system file each time it is loaded into memory. However since Delta PLC USB driver does not include the driver signature, this section will help users to disable driver signature enforcement functionality in Windows 8 to ensure a success Delta PLC USB installation. This act is only valid for a single time. The setting will return to its original state after restarting.

Steps to disable driver signature enforcement in Windows 8:

1. Press the button  **[WIN]+[I]** on the keyboard to see the Setting interface. Click “Change PC settings”.

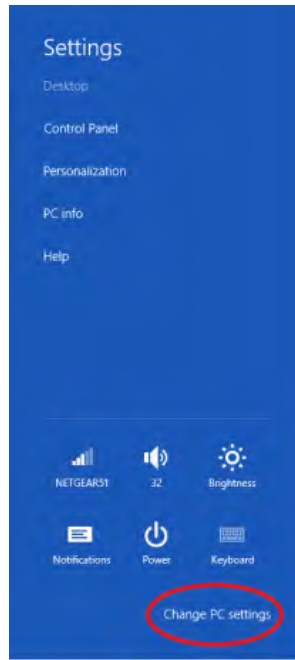

2. The PC settings window will appear. Select "General" and then "Restart now" under "Advanced startup".

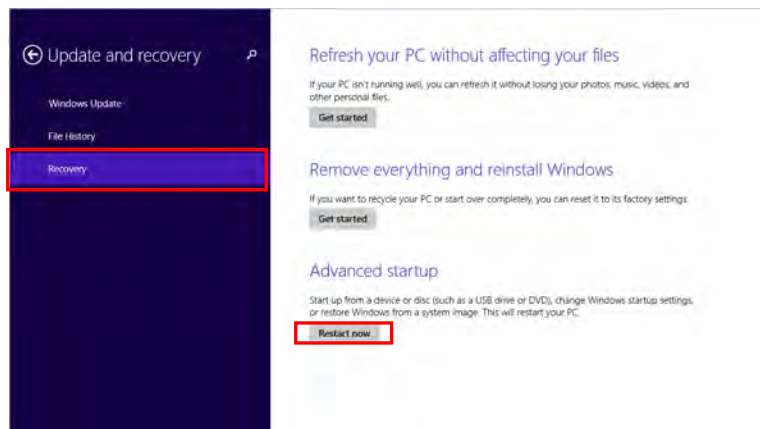
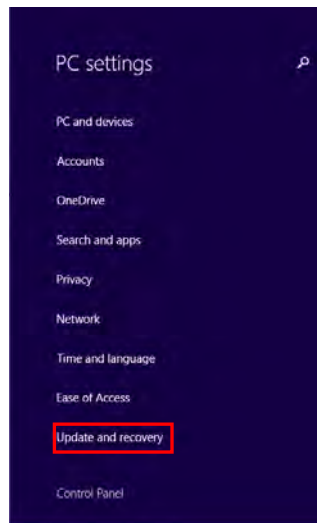

3. After the computer is restarted, select “Troubleshoot” under “Choose an option”. And then select “Advanced options”.

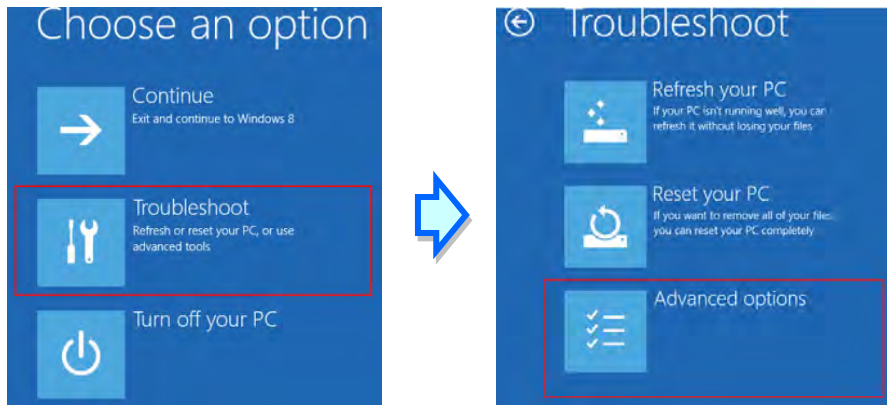

A

4. From the Advanced options page, select “Startup Settings” to see the Startup Settings. From this page select “Restart” to restart the computer.



5. Press “7” or “F7” to choose “Disable driver signature enforcement” and the system will direct you to the Windows 8 operating page. Users can then install the Delta PLC USB driver now.
6. For the Delta USB drive installation, please refer to installation in Windows 7 section.

A.4 Installing the USB Driver for an AH500 Series CPU module in Windows 10

Windows 10 driver signature enforcement provides a way to improve the security of the operating system by validating the integrity of a driver or system file each time it is loaded into memory. However since Delta PLC USB driver does not include the driver signature, this section will help users to disable driver signature enforcement functionality in Windows 10 to ensure a success Delta PLC USB installation. This act is only valid for a single time. The setting will return to its original state after restarting.

Steps to disable driver signature enforcement in Windows 10:

1. Click Start and then Settings.

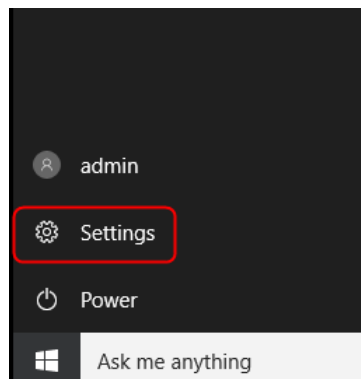

2. Select Update & security

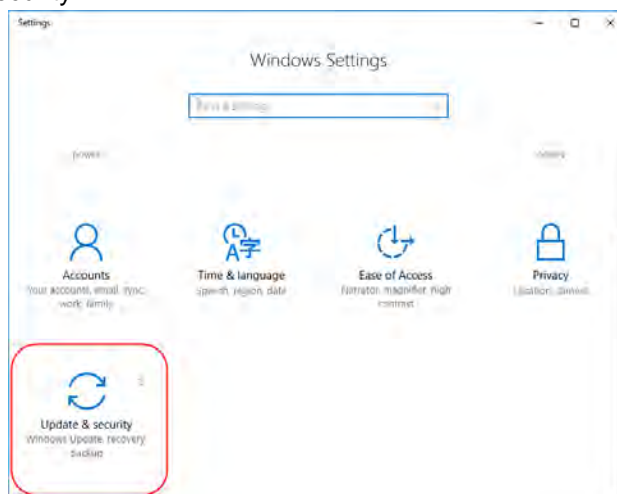

A

3. Select Recovery and Restart now.

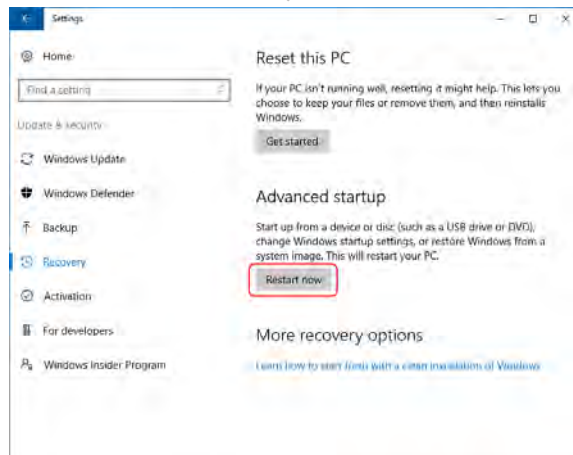
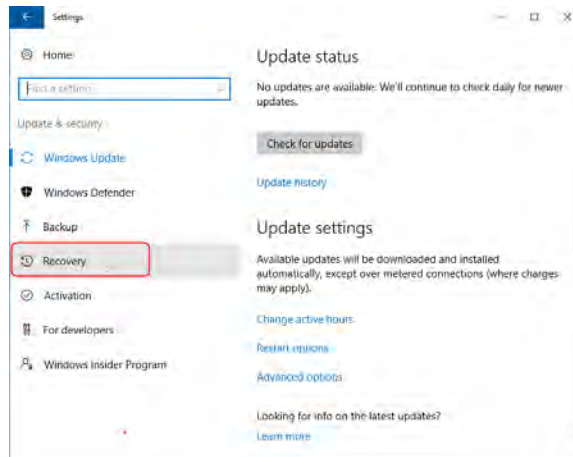

4. After the computer is restarted, select "Troubleshoot" under "Choose an option". And then select "Advanced options".

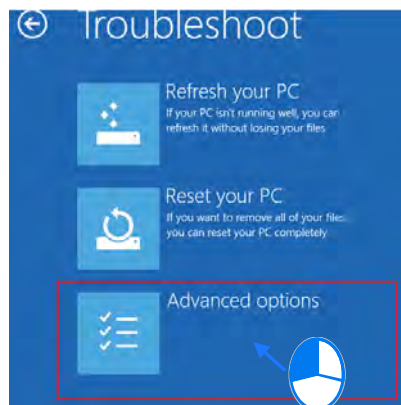
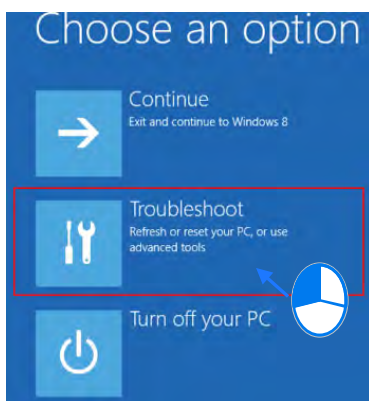

5. From the Advanced options page, select “Startup Settings” to see the Startup Settings. From this page select “Restart” to restart the computer.

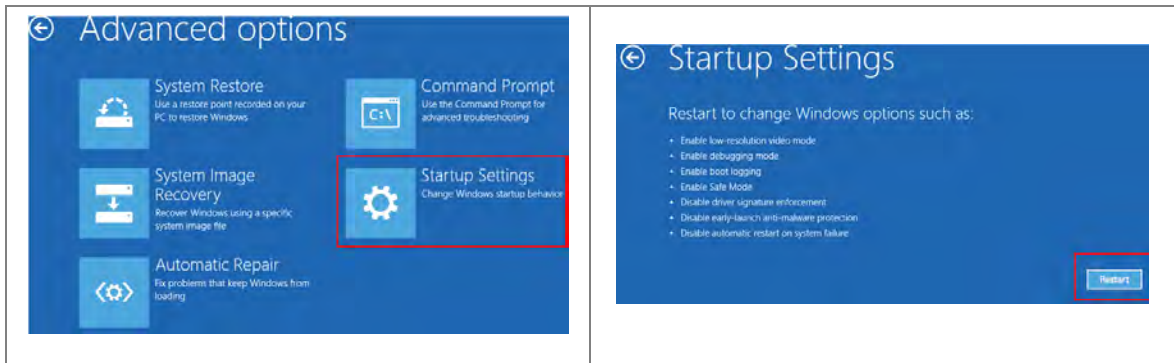

6. Press “7” or “F7” to choose “Disable driver signature enforcement” and the system will direct you to the Windows 10 operating page. Users can then install the Delta PLC USB driver now.

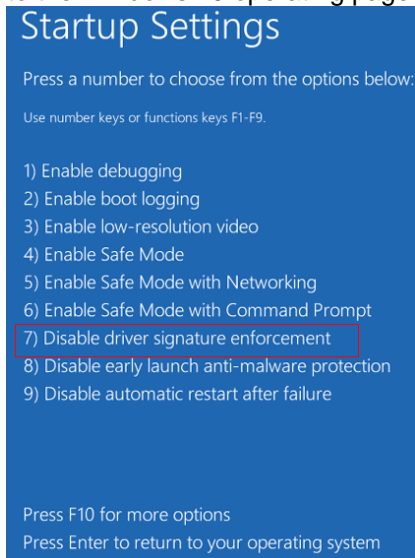

7. For the Delta USB drive installation, please refer to installation in Windows 7 section.



MEMO





Appendix B Device Addresses

Table of Contents

B.1	Device Addresses	B-2
-----	------------------------	-----

B.1 Device Addresses

Standard Modbus addresses of devices:

Device	Type	Format	Device range	Modbus address (Decimal number)	AH500 Address (Hexadecimal number)
X	Bit	DDD.D	X0.0~X511.15	124577~132768	6000~7FFF
	Word	DDD	X0~X511	332769~333280	8000~81FF
Y	Bit	DDD.D	Y0.0~Y511.15	040961~049152	A000~BFFF
	Word	DDD	Y0~Y511	440961~441472	A000~A1FF
M	Bit	DDDD	M0~M8191	000001~008192	0000~1FFF
SM	Bit	DDDD	SM0~SM2047	016385~018432	4000~47FF
SR	Word	DDDD	SR0~SR2047	449153~451200	C000~C7FF
D	Word	DDDDD	D0~D32767	400001~432768	0000~7FFF
S	Bit	DDDD	S0~S2047	020481~022528	5000~57FF
T	Bit	DDDD	T0~T2047	057345~059392	E000~E7FF
	Word	DDDD	T0~T2047	457345~459392	E000~E7FF
C	Bit	DDDD	C0~C2047	061441~063488	F000~F7FF
	Word	DDDD	C0~C2047	461441~463488	F000~F7FF
HC	Bit	DD	HC0~HC63	064513~064576	FC00~FC3F
	DWord	DD	HC0~HC63	464513~464576	FC00~FC3F
E	Word	DD	E0~E31	465025~465056	FE00~FE1F

